

## Mouth Mirrors

Pack of 12 pieces

سر آینه ۱۲ عددی



- Made of 18-8 Stainless steel
- Sterilizable up to 200° C
- Best reflection and image quality

Fig	Plan	Magnifying
Fig. 4	F 509.040 K 1335	F 506.040 K 1333
Fig. 5	F 509.050 K 1336	



Fig. 4  
Ø 22 mm  
سر آینه شماره ۴



Fig. 5  
Ø 24 mm  
سر آینه شماره ۵

## Mirror Handles

دسته آینه  
هشت گوش



F 540.010  
K 1346

دسته آینه  
هالو



F 545.010  
K 1348

دسته آینه  
ارگونومیک



F 530.010

دسته آینه  
گرد آبی



F 526.010

دسته آینه  
گرد سبز



F 526.020

دسته آینه  
گرد زرد



F 526.030

دسته آینه  
گرد قرمز



F 526.040

دسته آینه  
گرد نارنجی



F 526.050

## Tweezers



F 901.150 پنس ارگونومیک



F 945.010 | K 1352 پنس دو خم



F 910.050 پنس یک خم



K 1351 پنس نوک تیز



F 930.050 | K 1360 پنس قفل دار



F 586.020 پنس اندودنتیک قفل دار



F 980.130 | K 1359 پنس گوتا (Angled)



F 981.130 پنس گوتا (Curved)

## Examination Kit

F 990.050 ست معاینه  
K 1001



## Explorers



F 105.050 سوند دو سر هالو



F 197.050 | K 1305 سوند دو سر



F 584.167 سوند دو سر



F 584.177 سوند دو سر



F 584.237 | K 1306 سوند دو سر



K 1307 سوند دو سر



F 397.230 | K 1301 سوند یکسر داسی



K 1302 سوند یکسر



K 1303 سوند یکسر



F 397.080 | K 1304 سوند یکسر اندو

### Contents

- 1 x F 540.010 | K 1346
- 1 x F 509.040 | K 1335
- 1 x F 197.050 | K 1305
- 1 x F 945.010 | K 1352

- دسته آینه
- سر آینه
- سوند
- پنس

## Curettes Classic - 8

### قلم های جرمگیری دسته ساده

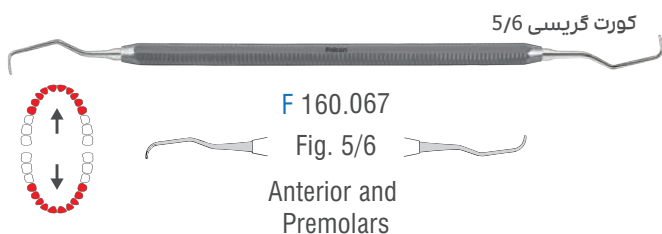
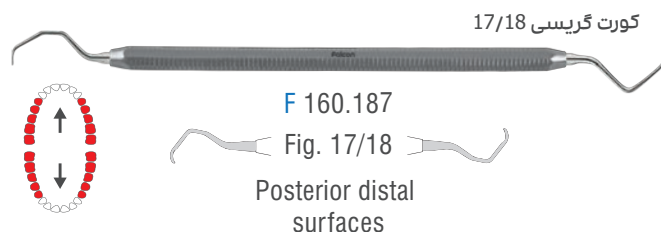
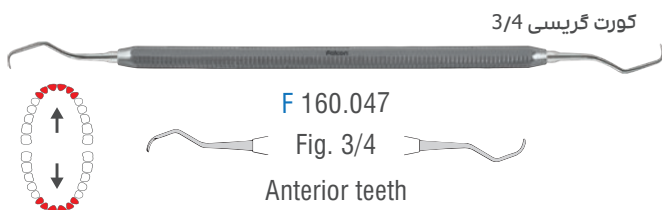
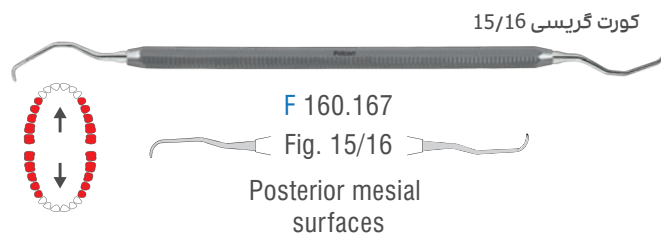
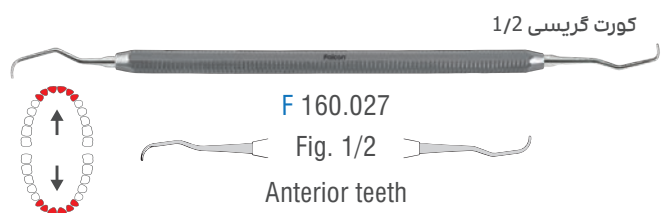

## Sickle Scaler

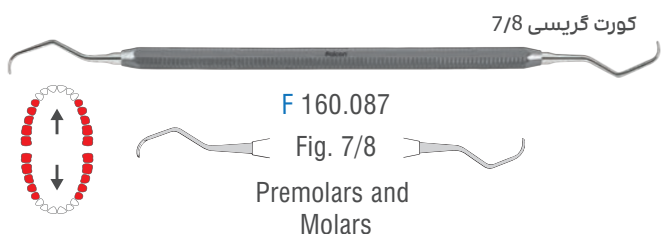
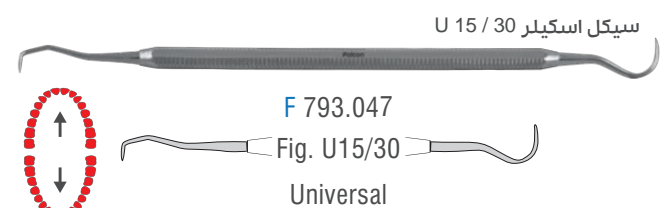

## Columbia

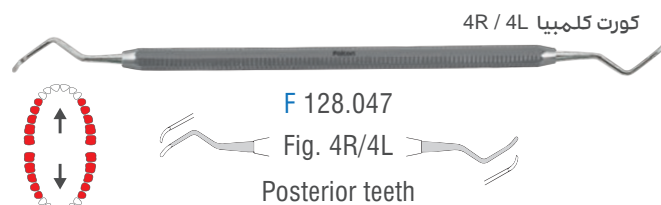
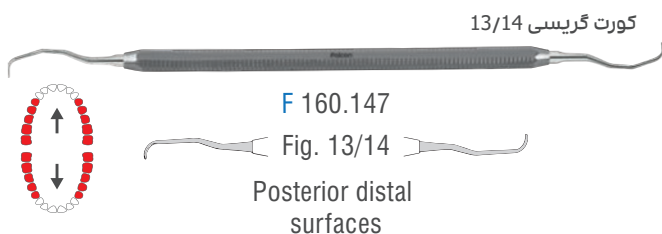
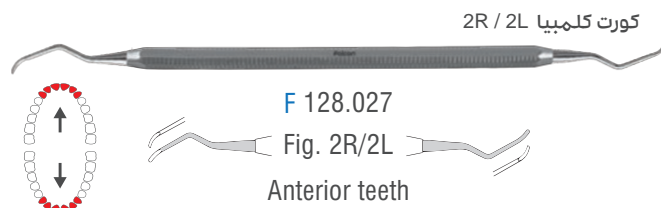
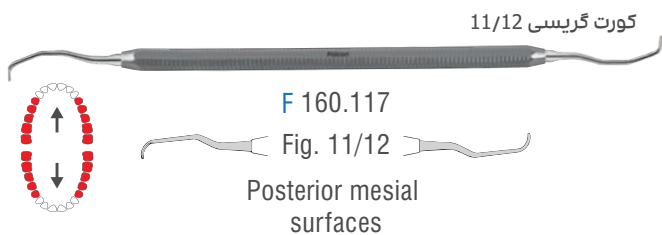
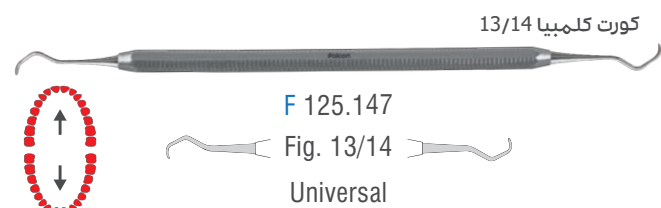
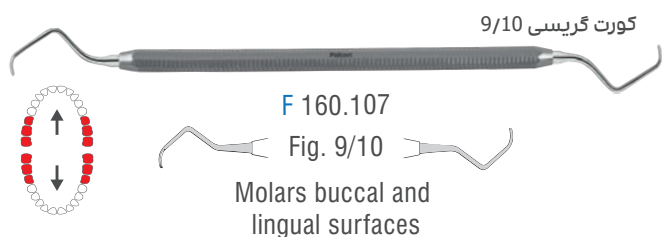

## Curettes Classic Lite

### قلم های جرمگیری دسته هالو

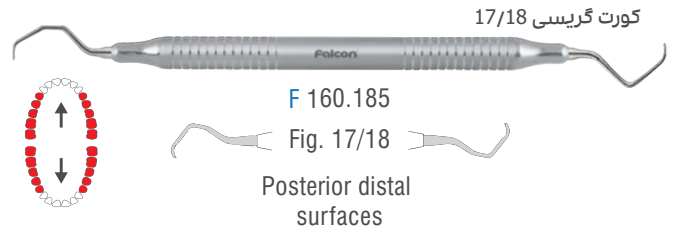
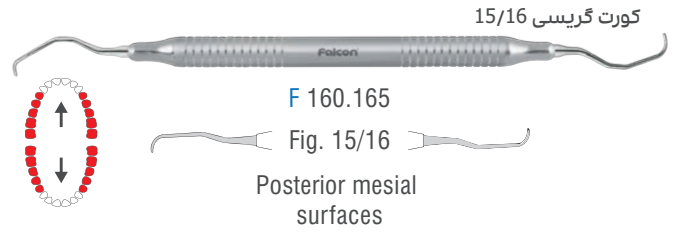
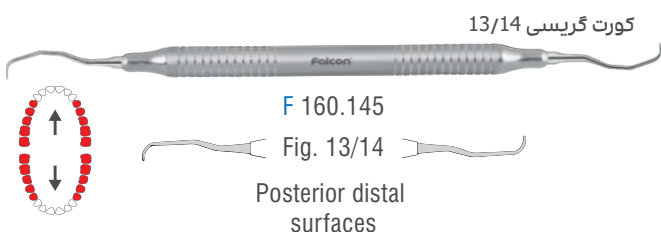
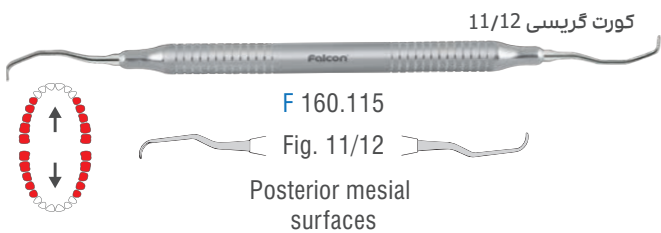
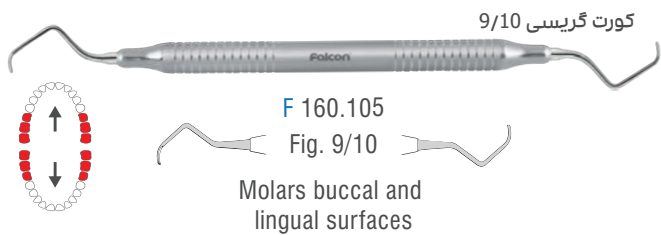
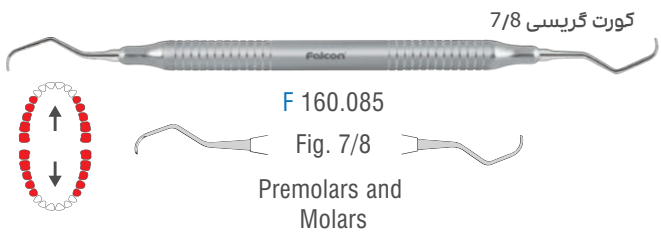
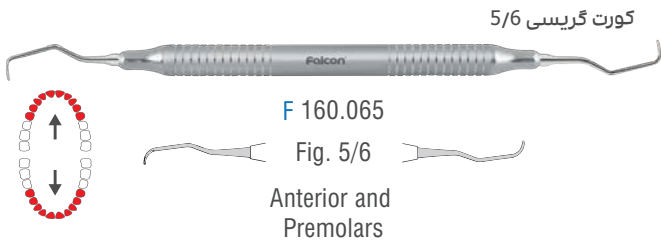
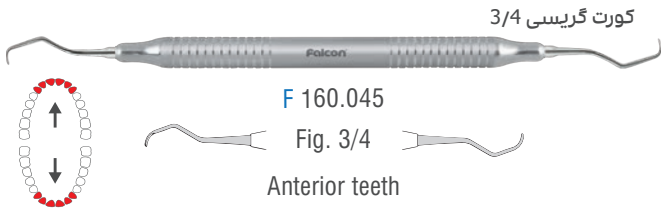
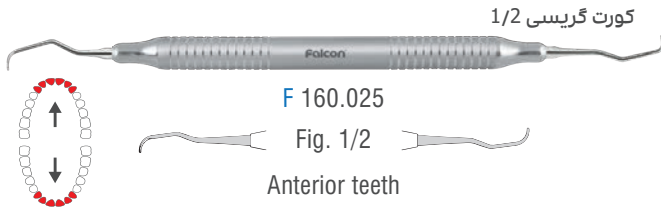

## Sickle Scaler

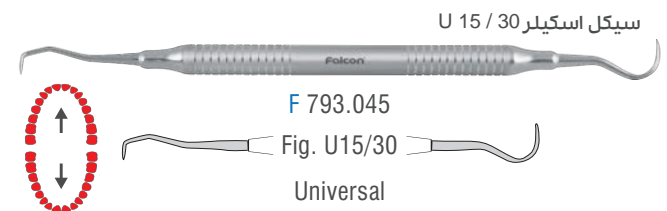

## Williams Probes



## Compo-fill Instruments

### قلم های کامپوزیت دسته ساده



**K 1883**  
Wescott 2.0 - 2.5 mm



**K 1884**  
Wescott 3.0 - 3.5 mm



**K 1885**  
Plastic Filling Rigid 3.0x11.5 3.0x9.5 mm



**K 1886**  
Condenser & Headmen spatual rigid



**K 1887**  
Plastic Filling 2.0x10.0 2.0x8.5 mm



**K 1888**  
Plastic Filling 2.0x10.0 2.0x8.5 mm



**K 1889**  
Plastic Filling 2.0x11.5 2.5x9.5mm



**K 1890**  
Freedman Condenser, 1.0 MM 1.3mm



**K 1891**  
Condenser, 1.6 mm Mini Spatual/placer 3.0 mm



**K 1892**  
Condenser WORD (cutt) & spatual rigid



**K 1893**  
Hollen back & Condenser mini cutt



**K 1894**  
Freedman cone shape & Condenser



**K 1895**  
Burnisher 1.3 -1.6 mm



**K 1896**  
burnisher 1.6 mm , 2.2 mm



**K 1897**  
Smooth plugger 2.5mm 2.5 mm



**K 1898**  
Headman rigid & cement Spatual (curv)



**K 1899**  
Universal rigid & Lekran 3.0 mm 4.0



**K 1900**  
Boghosiyian

## Compo-fill Instruments قلم های کامپوزیت دسته هالو



**K 1401**  
Burnisher 1.3 - 1.6 mm



**K 1402**  
Plugger sharp (hollen-back)



**K 1403**  
Plugger (hollen-back) 2.5



**K 1404**  
Freedman condenser ,markly-S



**K 1405**  
Freedman condenser , markly-L



**K 1406**  
Westcott (s) 2.0 - 2.5 mm



**K 1407**  
Westcott (L) 3.0 - 3.5 mm



**K 1408**  
Plastic instruments & condenser sharp 1.6 -1.2mm-S



**K 1409**  
Plastic instruments & condenser - L



**K 1410**  
Heidemann spatula-S



**K 1411**  
Heidemann spatula 2.0 mm-L



**K 1412**  
Heidemann-1.5mm



**K 1413**  
Plastic filling instrument elastic 2 mm



**K 1414**  
Plastic filling instrument elastic 2.5 mm



**K 1415**  
Placement instruments mini spatula/placer



**K 1416**  
Plastic filling Rigid-L



**K 1417**  
Plastic filling Rigid 2.0 mm



**K 1418**  
Cement spatula 2.0 mm flexible



**K 1419**  
Mini spatula /placer pluggar 3.1 mm 101 mm



**K 1420**  
Bagoshian



**K 1421**  
Heidemann rigid & cement Spatula



**K 1422**  
Super plugger (heleomolar type)

## Pluggers

## کندانسورهای آمالگام مخروطی



## کندانسورهای کامپوزیت (بدون عاج)



## کندانسورهای آمالگام استوانه ای



## کندانسورهای مارکلی



## برنیشر لادمر



## Plugger - Burnisher

### برنیشر



F 130.017  
K 1501

Fig. 1



F 130.027  
K 1502

Fig. 2



F 130.037  
K 1503

Fig. 3



F 130.047  
K 1504

Fig. 4

### کندانسور - برنیشر



K 1510

Fig. 1



K 1511

Fig. 2



K 1512

Fig. 3



K 1513

Fig. 4

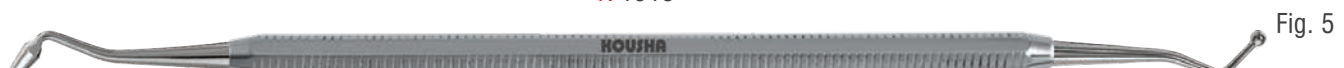

K 1514

Fig. 5

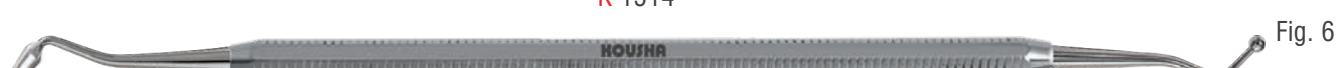

K 1515

Fig. 6

### تی برنیشر - برنیشر تخم مرغی



F 148.377  
K 1531

Fig. 29/32



F 148.067  
K 1535

Fig. 28/29



K 1525



K 1528



## Wescott

## برنیشتر وسکوت



F 110.217



F 111.217

## Filling Instruments

## اسپاتول دهانی



F 463.007

K 1487

Fig. 1



F 463.017

K 1466

Fig. 2



F 463.027

K 1467

Fig. 3

## Woodson Spatula

## اسپاتول ودسون



F 518.017

Fig. 1



F 518.027

Fig. 2



F 518.037

Fig. 3

## Spatula

## اسپاتول محکمہ



F 960.017

K 1451

Fig. 1



F 960.027

K 1452

Fig. 2



F 960.037

K 1453

Fig. 3

## Cord Packer

## قلم نخ زیر لثه



F 005.037

K 3246

## Dycal Placement

## قلم دایکال



F 872.001

دوسر

K 1598



F 872.002

یک سر

K 1597

## Excavators

اکسکویاتور

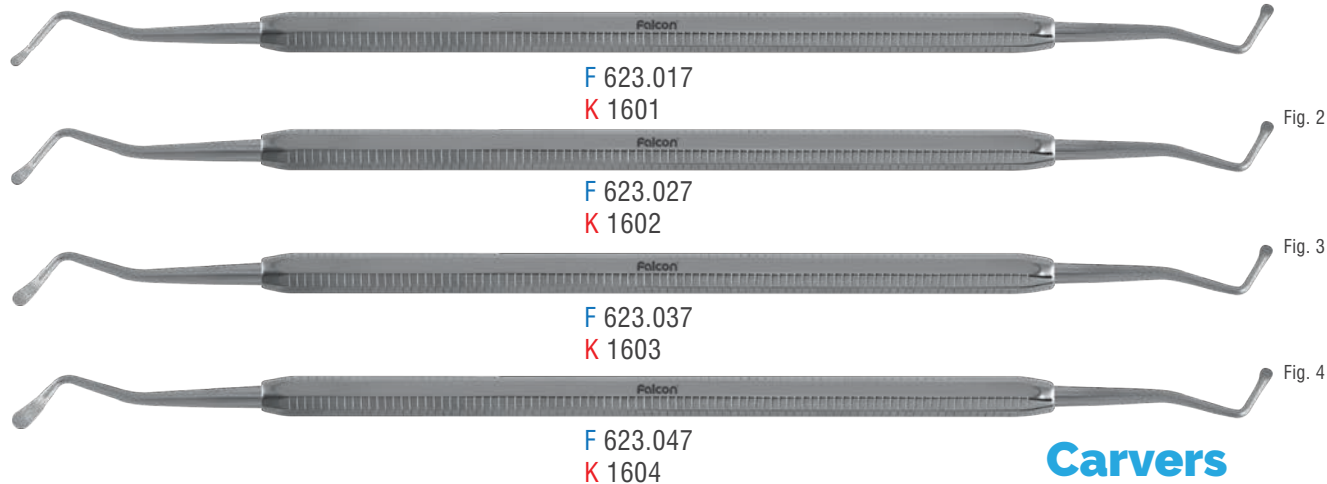

## Carvers

کارور لوزی ریز

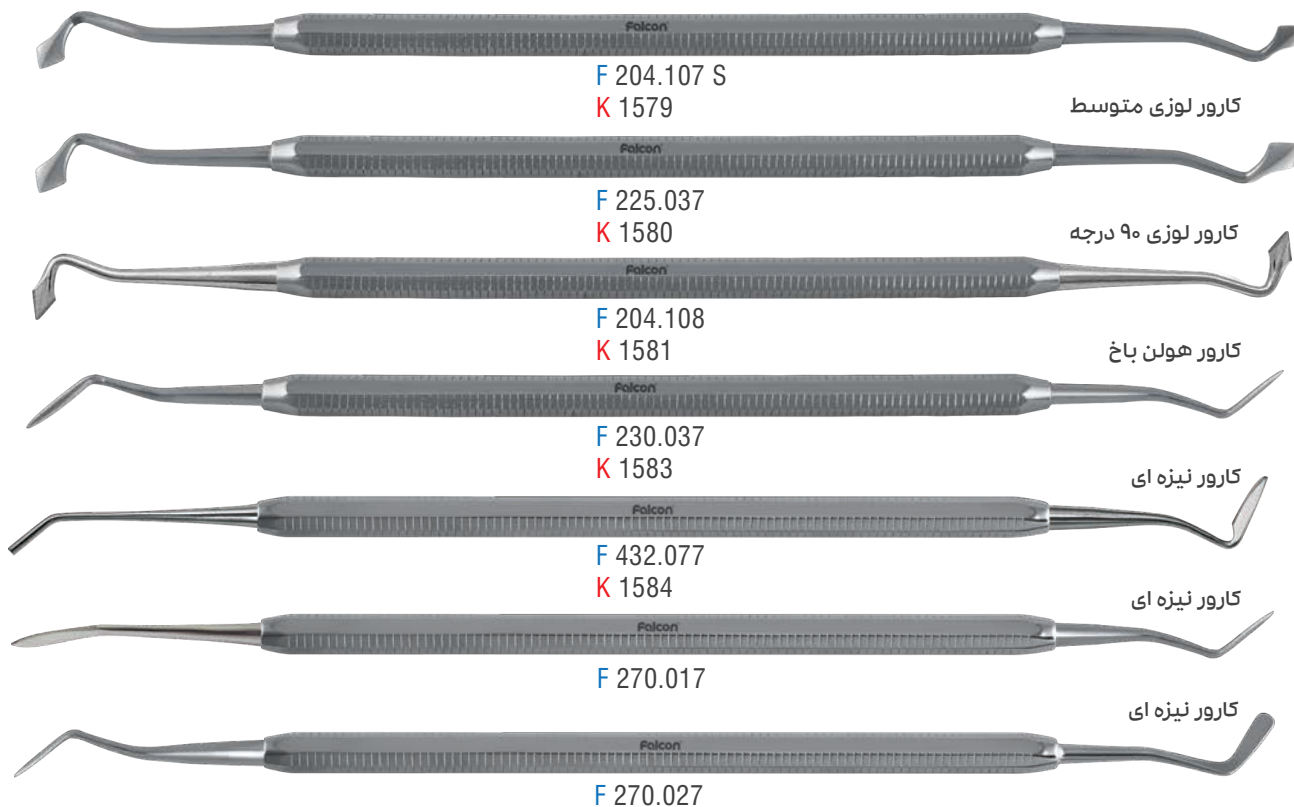

## Filling Instruments Set of 10 Pieces

ست ترمیم ۱۰ عددی

K 1500 F 999.007

Contents: 1 each of following :

K 1501 F 089.017

K 1502 F 089.027

K 1542 F 130.027

K 1543 F 130.037

K 1602 F 463.017

K 1580 F 960.027

K 1531 F 623.027

K 1467 F 225.037

K 1453 F 148.377

K 1597 F 872.002





## Amalgam Carrier



F 028.010  
K 1628

آمالگام کریر



F 022.101

آمالگام کریر  
قابل تنظیم



F 026.010

آمالگام کریر  
۴۵ درجه



F 026.020

آمالگام کریر  
۶۰ درجه



F 026.030

آمالگام کریر  
۹۰ درجه



F 028.000

آمالگام کریر پلاستیکی  
قابل اتوکلاو  
(همراه با سری اضافه)

## MTA Carrier

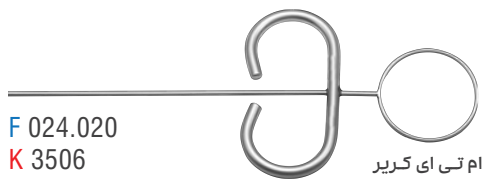

F 024.020  
K 3506  
Ø 1.2x1.5 mm

ام تی ای کریر  
سر صاف نازک

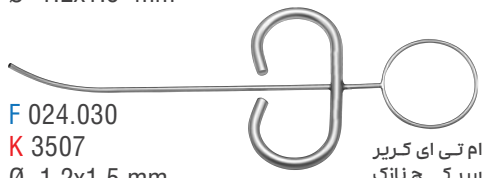

F 024.030  
K 3507  
Ø 1.2x1.5 mm

ام تی ای کریر  
سر کج نازک

## Amalgam Well کوده آمالگام



F 098.010



K 1646



K 1647

## Matrix Retainers



F 840.010

ماتریس بند  
اطفال



F 840.030  
K 1441

ماتریس بند  
تافل مایر



F 830.087

ماتریس بند  
مبا



F .832.010

ماتریس بند  
نی استروم چپ



F 832.020

ماتریس بند  
نی استروم راست



F 830.120

ماتریس بند  
چنگکی

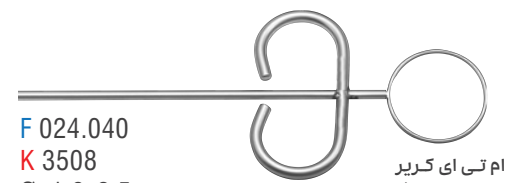

F 024.040  
K 3508  
Ø 1.8x2.5 mm

ام تی ای کریر  
سر صاف

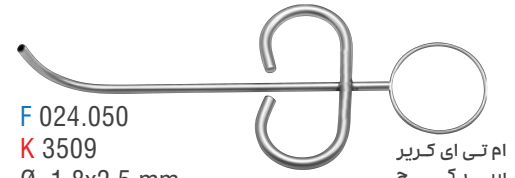

F 024.050  
K 3509  
Ø 1.8x2.5 mm

ام تی ای کریر  
سر کج

## Manual Crown and Bridge Remover



آرچ کروان ساده  
K 3201  
Complete with 4 tips



آرچ کروان ساده  
F 554.000  
Complete with 3 tips



کروان اسپریدر  
K 3220

## Automatic Crown and Bridge Remover



آرچ کروان اتوماتیک  
F 549.000  
K 3210  
3 Tips  
1 Mounting kit  
(wrench and key)



آرچ کروان اتوماتیک دکمه ای  
F 552.000  
Contents  
1 crown remover  
3 tips  
1 tightening key



آرچ کروان اتوماتیک دکمه ای  
K 3212  
Contents  
1 crown remover  
4 tips

## Rubber Dam Clamps



پرمولر بالا و  
پایین بدون باله  
F 906.020  
K 1675  
Fig. 27



قصدامی  
بالا و پایین  
F 906.090  
K 1670  
Fig. 9



پرمولر  
و کانین پایین  
F 906.100  
K 1663  
Fig. 00



پرمولر بالا و  
پایین کوچک  
F 906.130  
K 1664  
Fig. 2



پرمولر بالا و  
پایین بزرگ  
F 906.140  
K 1665  
Fig. 2A



پرمولر بالا و  
پایین با باله  
F 906.150  
K 1678  
Fig. 206



پرمولر  
پایین کوچک  
F 906.180  
K 1679  
Fig. 209



قصدامی  
بالا و پایین  
F 906.210  
K 1680  
Fig. 210



قصدامی  
بالا و پایین  
F 906.211  
K 1681  
Fig. 211



قصدامی  
بالا و پایین  
F 906.212  
K 1682  
Fig. 212



مولر بالا  
بدون باله  
F 906.370  
K 1674  
Fig. 26



مولر بالا  
و پایین  
F 906.500  
K 1666  
Fig. 3



مولر  
پایین  
F 906.530  
K 1667  
Fig. 7



مولر  
بالا کوچک  
F 906.550  
K 1668  
Fig. 8



مولر  
بالا بزرگ  
F 906.560  
K 1669  
Fig. 8A



مولر بالا  
چپ و راست  
F 906.570  
K 1671  
Fig. 12A



مولر بالا  
و پایین کوچک  
F 906.590  
K 1672  
Fig. 14



مولر بالا  
و پایین بزرگ  
F 906.600  
K 1673  
Fig. 14A



مولر بالا  
کوچک  
F 906.620  
K 1676  
Fig. 201



مولر  
بالا بزرگ  
F 906.660  
K 1677  
Fig. 205

## Rubber dam clamps kit

## ست کلمپ رابردم اعددی

F 909.100  
K 1662  
1 each of  
Fig. 00, 2, 2A, 3, 7, 8A, 9, 14, 14A, 212



## Rubber Dam Clamp Forceps

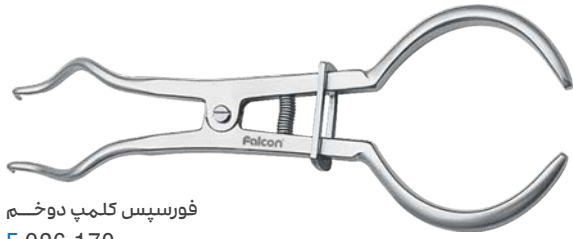

فورسپس کلمپ دو خم  
F 926.170  
K 1652



فورسپس کلمپ یک خم  
F 932.170  
K 1651



فورسپس کلمپ ایوری  
F 928.170

## Rubber Dam Template & Clamps Tray

الگوی رابردم  
F 948.000  
Autoclavable

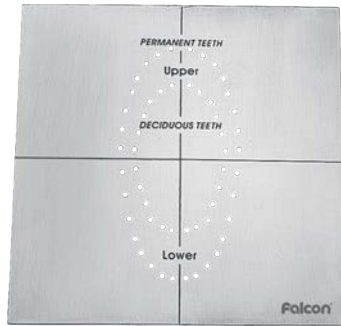

## Rubber Dam Kit Of 14 PCS

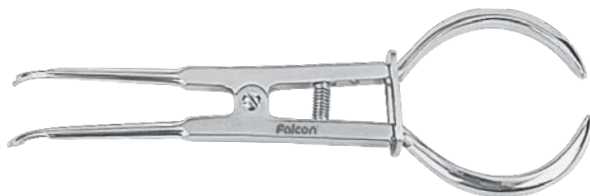

Fig. 9



Fig. 212



Fig. 2 A



Fig. 8A



Fig. 2



Fig. 00



Fig. 14



Fig. 7



Fig. 14 A



Fig. 3

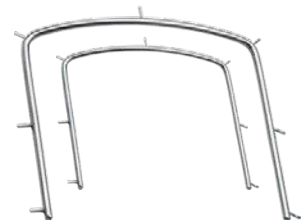

ست رابردم ۱۴ عددی  
F 909.900  
ست رابردم ۱۳ عددی  
K 1700

## Rubber Dam Punches

فورسپس پانچ  
F 940.160  
K 1654

## Matrix forceps



فورسپس سکشنال ماتریس  
F 820.170  
K 1438

## Rubber Dam Frames

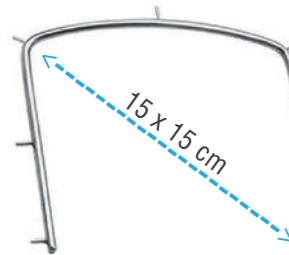

F 938.150

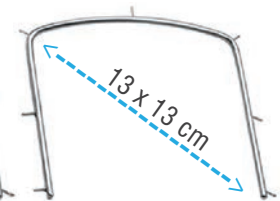

F 938.130



سینی کلمپ رابردم  
F 904.010  
Falcon

## Forceps for Articulating Paper

پنس کاغذ ارتیکلاسیون



F 698.010  
K 2751



F 700.010  
K 2752

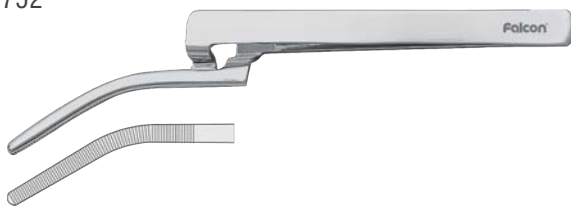

F 700.020

## Splinter Forceps



هموستات اندودنتیک ۹۰ درجه  
( مخصوص فایل های شکسته )  
F 995.060

## Latex Dental Dam

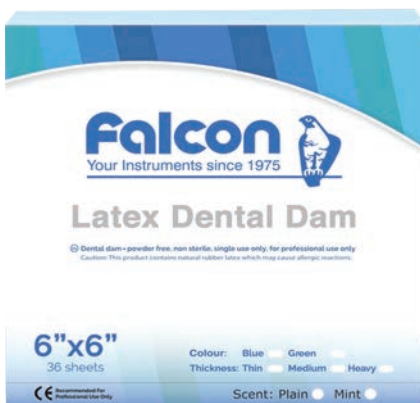

بسته 36 عددی  
رنگ : سبز  
طعم : نعنا

## Endometer



اندومتر  
بدون سوراخ  
F 575.000  
Endometer Petite  
Laser etched



اندومتر  
سوراخ دار  
F 575.010  
Endometer  
Laser etched



اندومتر  
بدون سوراخ  
K 1960

## Silver points and broken files removing forceps



هموستات اندودنتیک ۹۰ درجه  
F 587.130



بسته 36 عددی  
رنگ : آبی  
طعم : بدون طعم

## Pluggers هندپلاگر

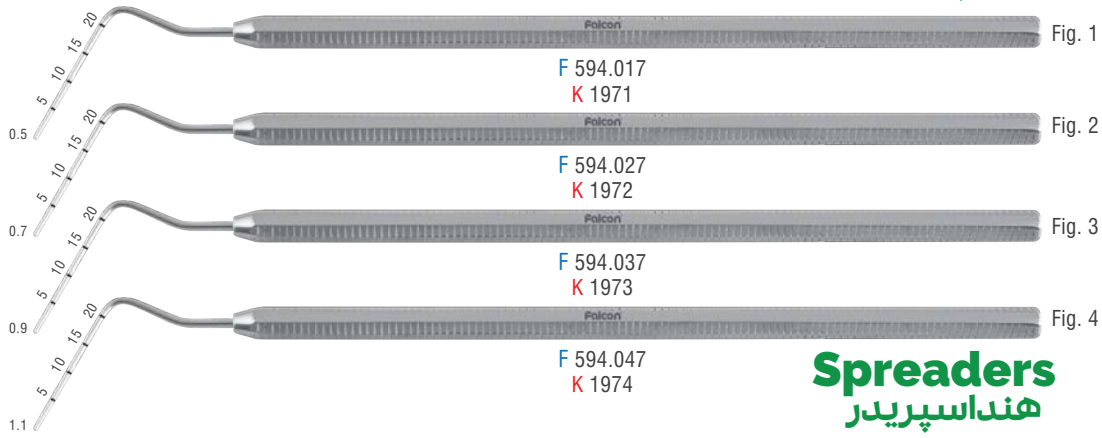

## Spreaders هند اسپریدر

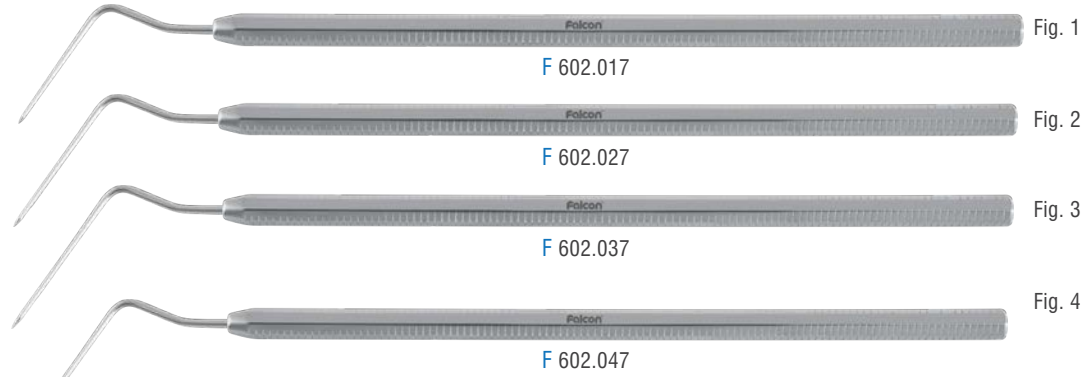

## Heat Carriers هیت کریر دسته هالو

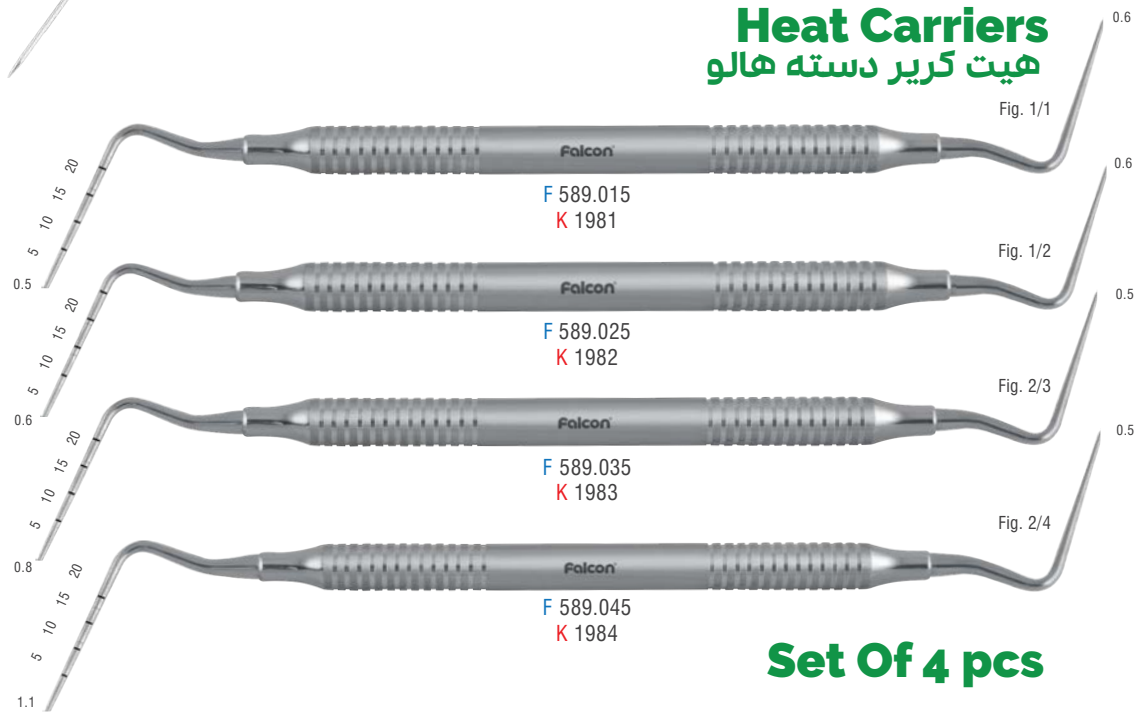

## Set Of 4 pcs



ست هند اسپریدر  
F 602.007



ست هندپلاگر  
F 594.007  
K 1980



ست هیت کریر  
F 589.005  
K 1990



## Intraligamental Syringes

### سرنگ تزریق



سرنگ تزریق  
تدریجی  
F 095.180  
Swedish Type  
Injects 0.06 ml with every click



سرنگ تزریق  
تفنگی  
F 060.180  
Pistol-Ject  
Injects 0.20 ml  
with every click  
Lever action for  
high injection pressure

## Manual Aspirating Floding Syringes

### سرنگ تزریق کم‌رشن



F 819.180  
K 2251



Superme  
K 2252

## Manual Aspirating Fix Syringes

### سرنگ تزریق ثابت



Type-C  
F 562.180



K 2254

## Needle Re-capper

### نیدل ریکاپر اولتیما



Ultima  
F 990.000



Falcon Needle Re-Cappers are the ideal way to prevent needle stick injuries when recapping needles. Place the upturned needle cap into Falcon Re-Capper and re-sheathing becomes a simple one hand procedure.

## Bein Elevators Round Tips

### الواترهای سرصاف

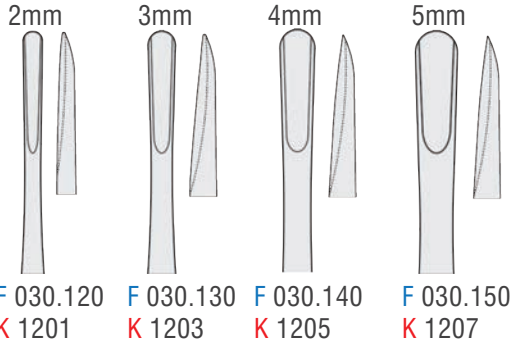

### الواترهای سرکج (پاشنه ای)

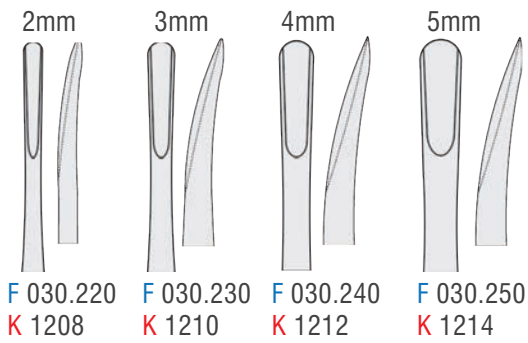

## Luxation Elevators

### الواترهای لوگزتینگ سرصاف

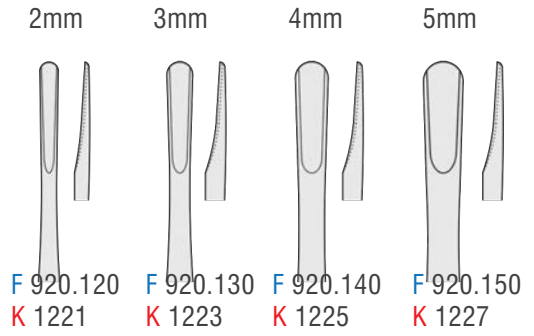

### الواترهای لوگزتینگ سرکج (پاشنه ای)

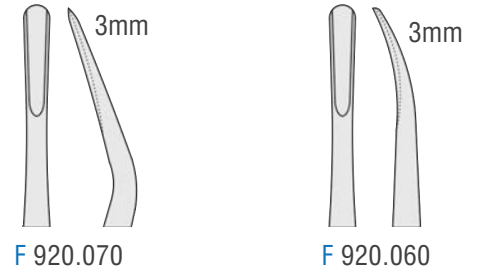
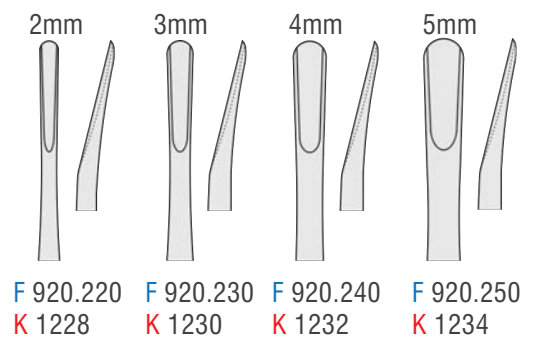

## Elevators Set Of 7 pcs

### ست الواتر ۷ عددی



- |           |           |
|-----------|-----------|
| F 999.008 | K 1300    |
| Contents  | Contents  |
| 1 each of | 1 each of |
| F 030.130 | K 1202    |
| F 030.140 | K 1203    |
| F 030.150 | K 1205    |
| F 070.250 | K 1241    |
| F 070.260 | K 1242    |
| F 086.022 | K 1253    |
| F 086.032 | K 1254    |

## Bein Elevators Pointed Tips

### الواترهای نوک تیز سرصاف

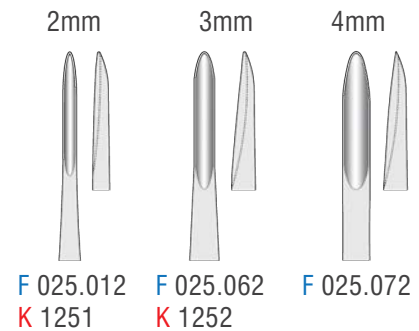

### الواترهای نوک تیز سرکج

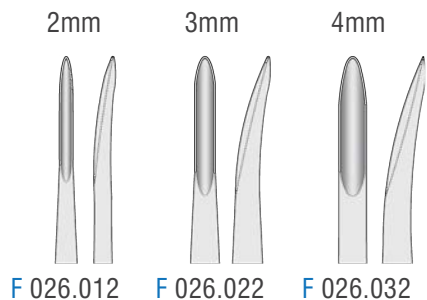

## Elevators

### الواتر کرایر

12.5 mm

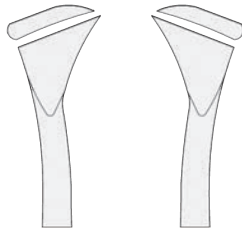

F 070.250  
K 1247  
Cryer Left

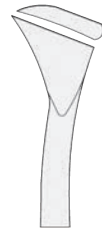

F 070.260  
K 1248  
Cryer Right

10 mm

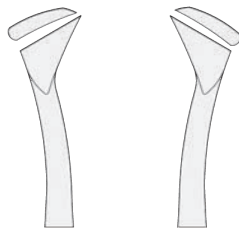

F 070.440  
K 1245  
Cryer Left

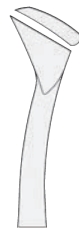

F 070.450  
K 1246  
Cryer Right



### الواتر فلوهر

3.5 mm



F 086.012  
Fig. 1  
Flohr

3.5 mm



F 086.022  
K 1253  
Flohr Left



F 086.032  
K 1254  
Flohr Right



### الواتر سلدین

13 mm

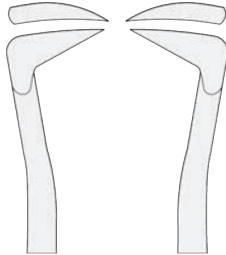

F 155.015  
K 1241  
Seldin Left



F 155.017  
K 1242  
Seldin Right

10 mm

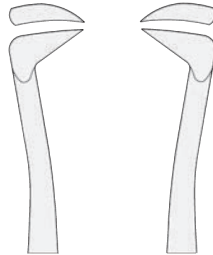

F 155.045  
Fig. 4 L  
Seldin Left



F 155.047  
Fig. 4 R  
Seldin Right



### الواتر اپیکال

3 mm



F 015.301  
Fig. 301  
Apical

3.5 mm



F 015.302  
Fig. 302  
Apical Left



F 015.303  
Fig. 303  
Apical Right

3.5 mm



F 015.304  
Fig. 304  
Apical



### الواتر کوپلن

3 mm



F 050.011  
Fig. 1  
Coupland

3.5 mm



F 050.021  
Fig. 2  
Coupland

4 mm



F 050.031  
Fig. 3  
Coupland



### الواتر دندانه دار سر صاف

4.2 mm

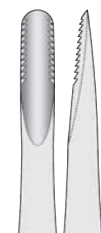

F 115.010  
K 1237  
Lendo-Levian

3.5 mm

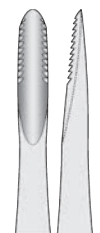

F 115.020  
K 1236  
Lendo-Levian

2.3 mm

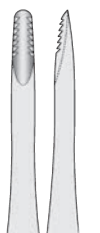

F 115.030  
K 1235  
Lendo-Levian



### الواتر فریدمن

3 mm

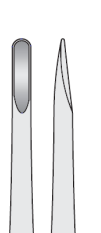

F 089.010  
Fig. 1  
Frideman

3 mm



F 089.020  
Fig. 2  
Frideman Left



F 089.030  
Fig. 3  
Frideman Right



### الواتر دندانه دار سر کج

4.2 mm



F 117.010  
Fig. 1  
Lendo-Levian

3.5 mm



F 117.020  
Fig. 2  
Lendo-Levian

2.3 mm

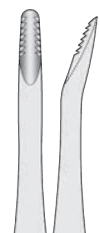

F 117.030  
Fig. 3  
Lendo-Levian



## Heidebrink Elevators

الواتر مخصوص ریشه

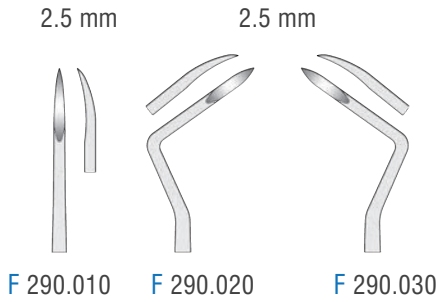

## Coleman London Hospital

الواتر کلمن

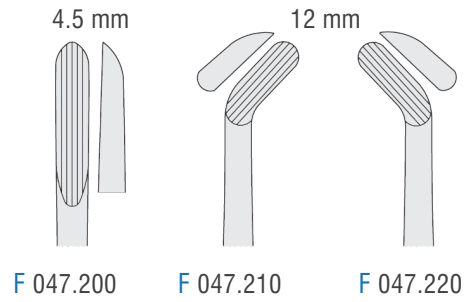

## Heidebrink Elevators

الواتر مخصوص ریشه ( دسته هالو )

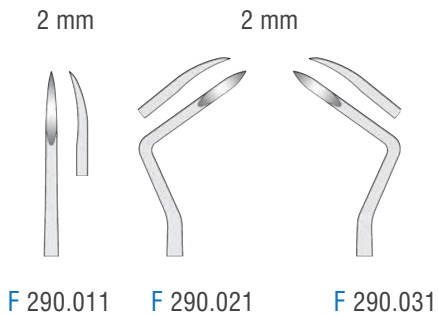

## Warwick-James Elevators

الواتر اطفال

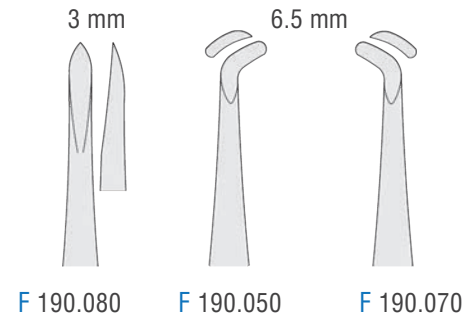

## Elevators Set

ست الواتر آناتومیک (۷ عددی)



- F 999.009  
Contents  
1 each of  
F 030.530  
F 030.540  
F 030.550  
F 070.251  
F 070.261  
F 086.021  
F 086.031

## Elevators Anatomical Handles

الواتر آناتومیک

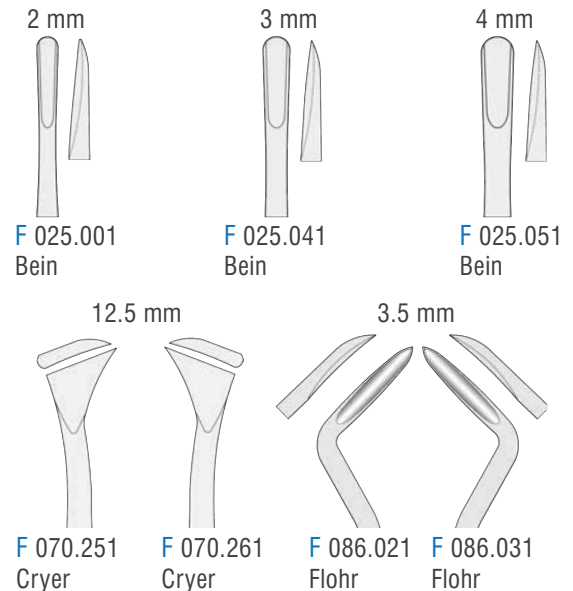

**Cross Bar Elevators**

الواتر صلیبی

10 mm

10 mm

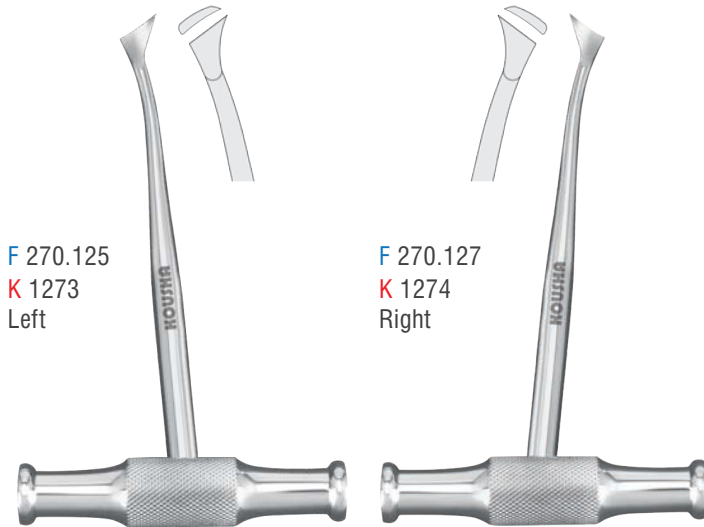
F 270.125  
K 1273  
LeftF 270.127  
K 1274  
Right**Bayonet Elevators**

الواتر نیزه ای

3 mm

5 mm

K 1256  
Offset  
Out TipK 1257  
Offset  
In Tip**PDL Periosteal Set**

ست پریوتوم های چکش خور

F 917.200 عددی ۷  
K 3350F 917.270  
K 3357F 917.260  
K 3356F 917.250  
K 3353F 917.240  
K 3355F 917.230  
K 3351F 917.220  
K 3352F 917.210  
K 3354**Extraction Physics Forceps**

فورسپس بزرگسال آتروماتیک

K 1134  
آتروماتیک  
قدامی بالاK 1133  
آتروماتیک  
یونیورسال پایینK 1132  
آتروماتیک  
بالا راستK 1131  
آتروماتیک  
بالا چپ

## Extraction Forceps Children Pattern

### فورسپس های اطفال فنردار



ست فورسپس اطفال  
فنردار ۷ عددی  
F 650.000  
K 1200



Fig. 137



سانترال بالا  
F 651.370  
K 1175

Fig. 139



پرمولر بالا  
F 651.390  
K 1176

Fig. 3



مولر بالا چپ و راست  
F 650.030  
K 1177

Fig. 51 S



ریشه کش بالا  
F 650.517  
K 1178

Fig. 7



ریشه کش پایین  
F 650.070  
K 1179

Fig. 6



مولر پایین  
F 650.060  
K 1180

Fig. 5



پر مولر پایین  
F 650.050  
K 1181

## Extraction Forceps Children Pattern

### فورسپس های اطفال بدون فنر



ست فورسپس اطفال  
بدون فنر ۱۰ عددی  
F 500.001



Fig. 37



سانترال بالا  
F 500.370  
Upper Incisors

Fig. 38



سانترال پایین  
F 500.380  
Lower Incisors and Canines

Fig. 30 S



ریشه کش بالا صاف  
F 500.307  
Upper Roots

Fig. 39



پرمولر بالا  
F 500.390  
Upper Molars

Fig. 39 L



مولر بالا چپ  
F 500.395  
Upper Molars Left

Fig. 39 R



مولر بالا راست  
F 500.397  
Upper Molars Right

Fig. 51 S



ریشه کش بالا  
F 500.517  
Upper Roots

Fig. 33 S



ریشه کش پایین  
F 500.337  
Lower Roots

Fig. 13 S



پرمولر پایین  
F 500.137  
Lower Premolars

Fig. 22 S



مولر پایین  
F 500.227  
Lower Molars

## Extraction Forceps European Pattern

فورسپس های بزرگسال (۱۱ عددی)



F 750.001  
K 1100  
1 each of : Fig. 2 , 7 , 13  
17 , 18 , 22 , 33A , 51A  
67 , 79 , 86A



Fig. 2



سانترال بالا  
F 750.020  
K 1102

Fig. 7



پرمولر بالا  
F 750.070  
K 1103

Fig. 17



مولر بالا راست  
F 750.170  
K 1104

Fig. 18



مولر بالا چپ  
F 750.180  
K 1105

Fig. 51 A

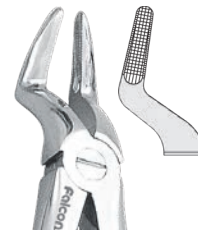

ریشه کش بالا  
F 750.511  
K 1106

Fig. 67

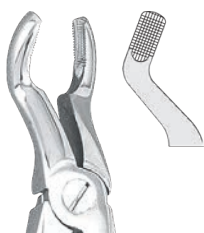

عقل بالا  
F 750.670  
K 1107

Fig. 13



پر مولر پایین  
F 750.130  
K 1108

Fig. 22



مولر پایین  
F 750.220  
K 1109

Fig. 33 A



ریشه کش پایین  
F 750.331  
K 1110

Fig. 79



عقل پایین  
F 750.790  
K 1111

Fig. 86 A



کاهورن پایین  
F 750.861  
K 1112

Fig. 89



کاهورن بالا راست  
F 750.890  
K 1114

Fig. 90



کاهورن بالا چپ  
F 750.900  
K 1115

Fig. 51 M

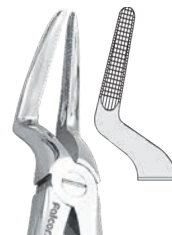

ریشه کش بالا نوک بلند  
F 750.515  
K 1119

Fig. 33 M



ریشه کش پایین نوک بلند  
F 750.335  
K 1120

Fig. 29 N



ریشه کش سانترال بالا  
F 750.295  
K 1121

Fig. 30 L

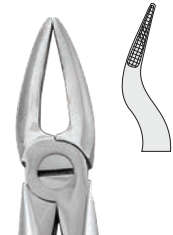

ریشه کش بالا باریک  
K 1122

Fig. 151 1/2



ریشه کش بالا نوک ویژه  
F 751.510

Fig. 86 C



کاهورن پایین محدب  
F 750.863  
K 1125

Fig. 87



کاهورن عقل  
F 750.870

## Extraction Forceps with Anatomical Handles

### فورسپس های بزرگسال آناتومیک

ست فورسپس  
آناتومیک ۱۱ عددی  
F 820.002



Fig. 2



سانترال بالا  
F 820.020

Fig. 7



پرمولر بالا  
F 820.070

Fig. 13



پر مولر پایین  
F 820.130

Fig. 17



مولر بالا راست  
F 820.170

Fig. 18



مولر بالا چپ  
F 820.180

Fig. 22



مولر پایین  
F 820.220

Fig. 33 A



ریشه کش پایین  
F 820.331

Fig. 51 A



ریشه کش بالا  
F 820.510

Fig. 67



عقل بالا  
F 820.670

Fig. 79



عقل پایین  
F 820.790

Fig. 86 A



کاهورن پایین  
F 820.861

Fig. 86 C



کاهورن پایین محدب  
F 820.863

Fig. 89



کاهورن بالا راست  
F 820.890

Fig. 90



کاهورن بالا چپ  
F 820.900

## Extraction Routurier Forceps



مولر  
پایین چپ  
K 1161  
Fig. 86 L



مولر  
پایین راست  
K 1162  
Fig. 86 R



کاهورن  
پایین چپ  
K 1163  
Fig. 86 L



کاهورن  
پایین راست  
K 1164  
Fig. 86 R



# Bone Thickness Gauges

## گیج های استخوان کاستویجو

**K 2785**  
Castroviejo  
Straight  
9 cm  
0-20 mm



**K 2786**  
Castroviejo  
Curved  
9 cm  
0-20 mm



**K 2787**  
Castroviejo  
Straight  
9 cm  
0-40 mm



**K 2788**  
Castroviejo  
Curved  
9 cm  
0-40 mm



**K 2789**  
Castroviejo  
Straight  
15 cm  
0-40 mm

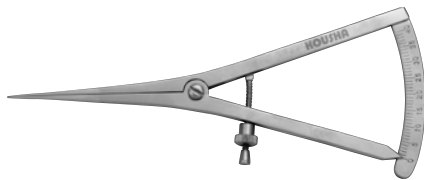

**K 2790**  
Castroviejo  
Curved  
15 cm  
0-40 mm

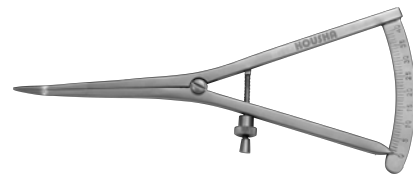

**K 2791**  
Castroviejo  
Straight  
15 cm  
0-40 mm

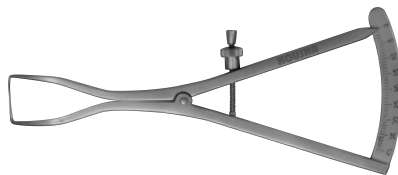

**K 2792**  
Castroviejo  
Straight  
17 cm  
0-40 mm



**K 2793**  
Castroviejo  
Curved  
17 cm  
0-40 mm



**K 2794**  
Castroviejo  
17 cm  
0-40 mm

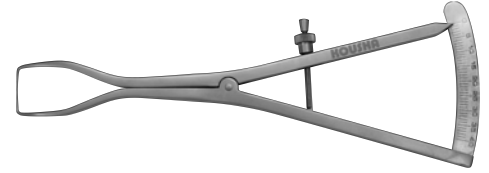

**F 803.010**  
**K 2795**  
Ridge Mapping  
0-25 Range



**F 804.010**  
Fig. 1  
Castroviejo  
Straight



**F 804.020**  
Fig. 2  
Castroviejo  
Curved



**F 804.030**  
Fig. 3  
Castroviejo



**F 804.040**  
Fig. 4  
Castroviejo



**F 804.050**  
Fig. 5  
Castroviejo



## Bone Mill

### بن میل ( آسیاب استخوان )

- Designed by Giuliano Lorenzetti, President of Falcon Medical Italia Srl.
- Simple and practical design
- Supplied with three interchangeable Titanium crushing heads of which two (fine and coarse serrations) for manual grinding and one for hammer percussion.
- Titanium bone container
- Registered Design



F 850.000 With TiN golden coating  
F 850.001 Without TiN coating

### Titanium Titanio

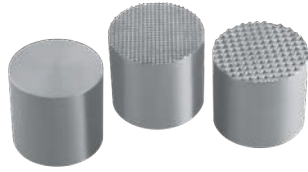

## Bone Well

### گوده استخوان



F 853.010



K 3465

## Bone Mill / Morselizer

### فورسپس بن میل



F 851.010  
K 3451

## Bone Scrapers

### بن اسکرپر سر صاف



F 849.010  
Stainless steel bone scraper straight, complete with one blade



بن اسکرپر سر کج



F 849.020  
Stainless steel universal blade for straight or curved bone scraper



تیغه یدک بن اسکرپر

F 849.030  
Stainless steel universal blade for straight or curved bone scraper

## Bone Collectors

### سرساکشن همراه با فیلتر

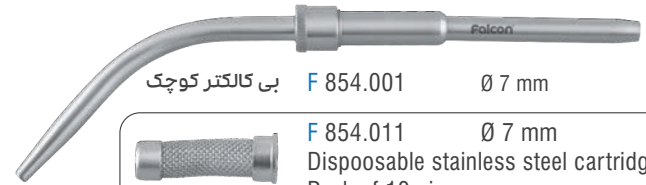

بی کالکتر کوچک F 854.001 Ø 7 mm

F 854.011 Ø 7 mm  
Disposable stainless steel cartridge  
Pack of 10 pieces

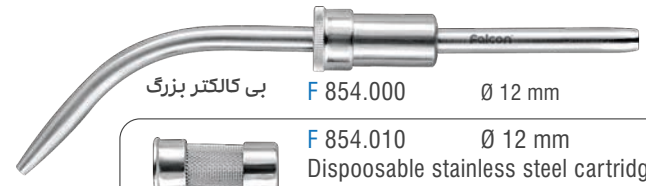

بی کالکتر بزرگ F 854.000 Ø 12 mm

F 854.010 Ø 12 mm  
Disposable stainless steel cartridge  
Pack of 10 pieces

## Bone Injectors

### بن کریر

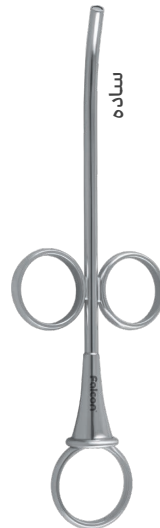

ساده

F 855.011  
Fig. 1

F 855.021  
Fig. 2

F 855.031  
Fig. 3

F 855.041  
Fig. 4

F 855.010  
Fig. 1

F 855.020  
Fig. 2

F 855.030  
Fig. 3

F 855.040  
Fig. 4

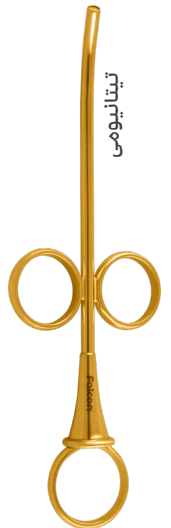

تیتانیومی

## Periotomes

پریوتوم



Anterior | F 846.015 | Fig. 1



Posterior | F 846.025 | Fig. 2

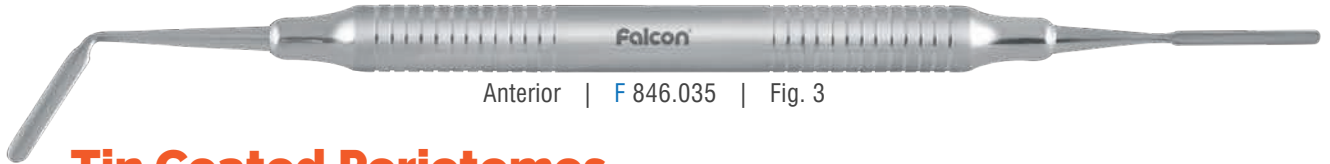

Anterior | F 846.035 | Fig. 3

## Tin Coated Periotomes

پریوتوم روکش تیتانیوم



Posterior | K 3455 | Fig. 1



Anterior | K 3456 | Fig. 2



Anterior Straight | K 3457 | Fig. 1



Anterior Straight Curved | K 3458 | Fig. 2



Anterior Angle Curved | K 3459 | Fig. 3



Anterior Curved | K 3460 | Fig. 4

## Titanium Periosteal Elevators

الواتور پریوست های تیتانیومی



Buser | F 832.015 T | Fig. 1



Prichard | F 839.035 T | Fig. 3



Molt Hollow | K 1715 T | Fig. 1



Buser | K 1720 T | Fig. 2

## Periosteal Elevators and Raspatories

الواتور های پریوست



Molt Small  
F 660.097  
K 1709



Molt Medium  
F 660.098  
K 1710

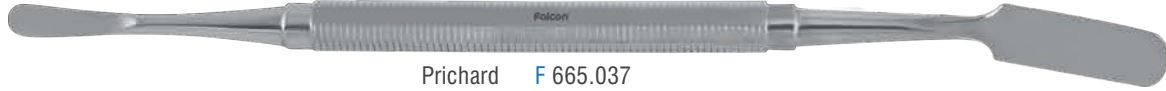

Prichard  
F 665.037  
K 1862



OHL | F 663.100 | Fig. 10



Allen | F 830.091 | Fig. 9 A



Buser | F 832.015 | Fig. 1



Buser | F 832.025 | Fig. 2



Buser | F 832.035 | Fig. 3



Raspatory For Fine Tissue | F 845.015 | Fig. 1



Raspatory For Fine Tissue | F 845.025 | Fig. 2



Atraumatic Papilla elevator | F 838.015 | Fig. 1



F 828.250 | Fig. 25

## Applicators and Compactors

قلم های حمل مواد و کامپکتور

F => FALCON  
K => KOUSHA

**Falcon**  
Your Instruments since 1975



Applicator bone | F 863.015 | Fig. 1



Applicator and compactor | F 864.015 | Fig. 1



Bone compactor | F 865.015 | Fig. 1



Bone compactor | F 865.025 | Fig. 2

## Membrane Placement Instruments



قلم ممبران | F 867.015



پنس ممبران | F 868.010

## Open Sinus Lift Set

ست سینوس لیفت اپن

K 3380



K 3381

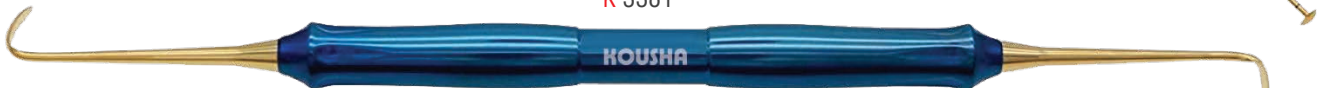

K 3382

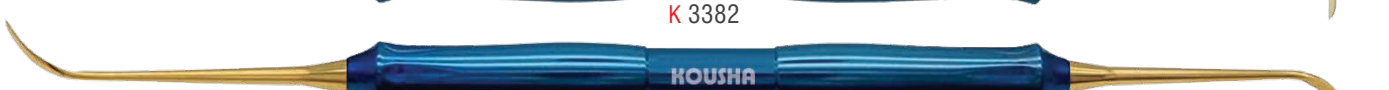

K 3383

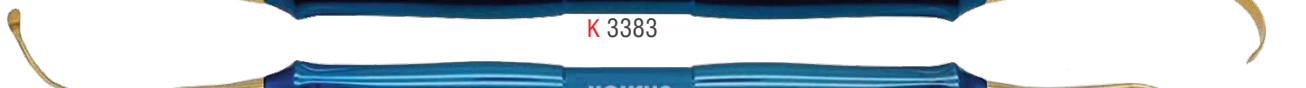

K 3384

## Open Sinus Lift Set

ست سینوس لیفت اپن

F 874.005 t



F 874.015 t

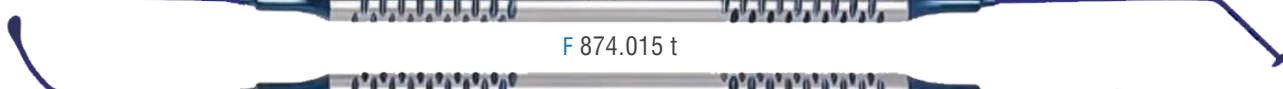

F 874.025 t



F 874.035 t



F 874.045 t

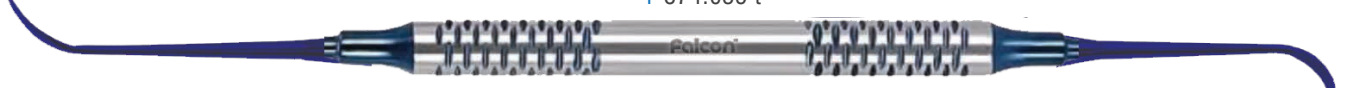



**Sinus Lift Curettes**

**Sinus Lift Elevators**

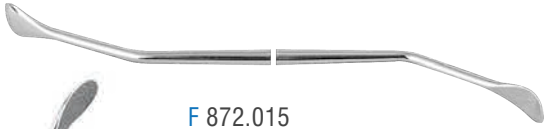

F 872.015  
Fig. 1



F 873.015  
Fig. 1

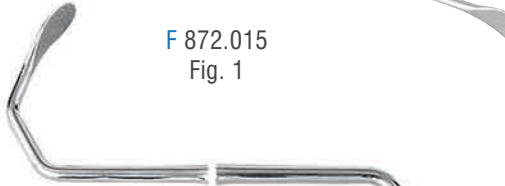

F 872.025  
Fig. 2



F 873.025  
Fig. 2

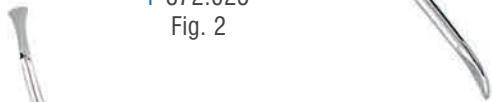

F 872.035  
Fig. 3



F 873.035  
Fig. 3



F 872.045  
Fig. 4



F 873.045  
Fig. 4



F 872.055  
Fig. 5



F 873.055  
Fig. 5

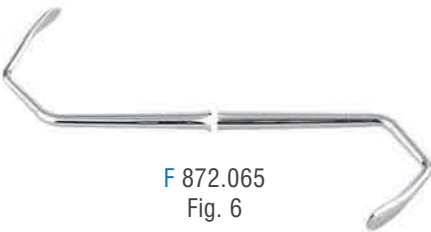

F 872.065  
Fig. 6



F 873.065  
Fig. 6

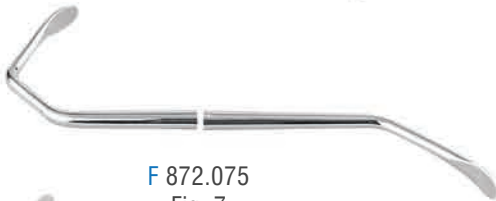

F 872.075  
Fig. 7



F 873.075  
Fig. 7

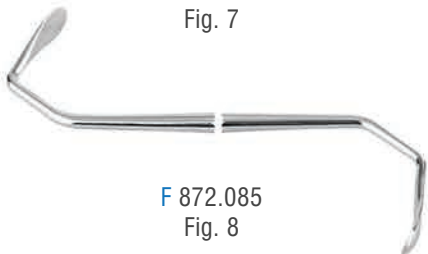

F 872.085  
Fig. 8



F 873.085  
Fig. 8

# Open Sinus Lift

سينوس ليفت

K => KOUSHA



## Dulled

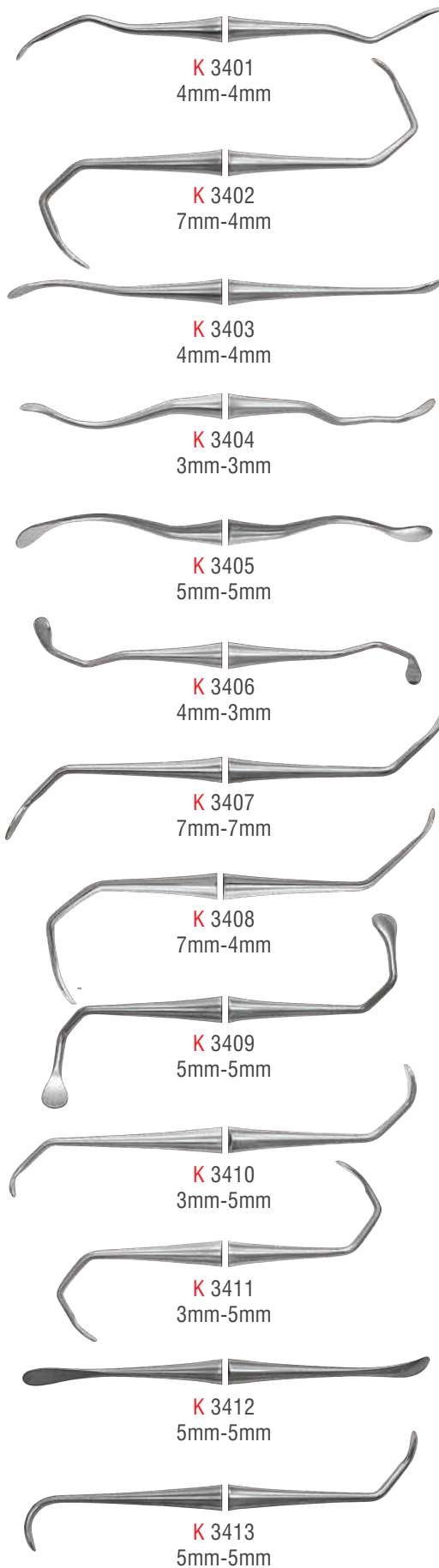

## Cutting

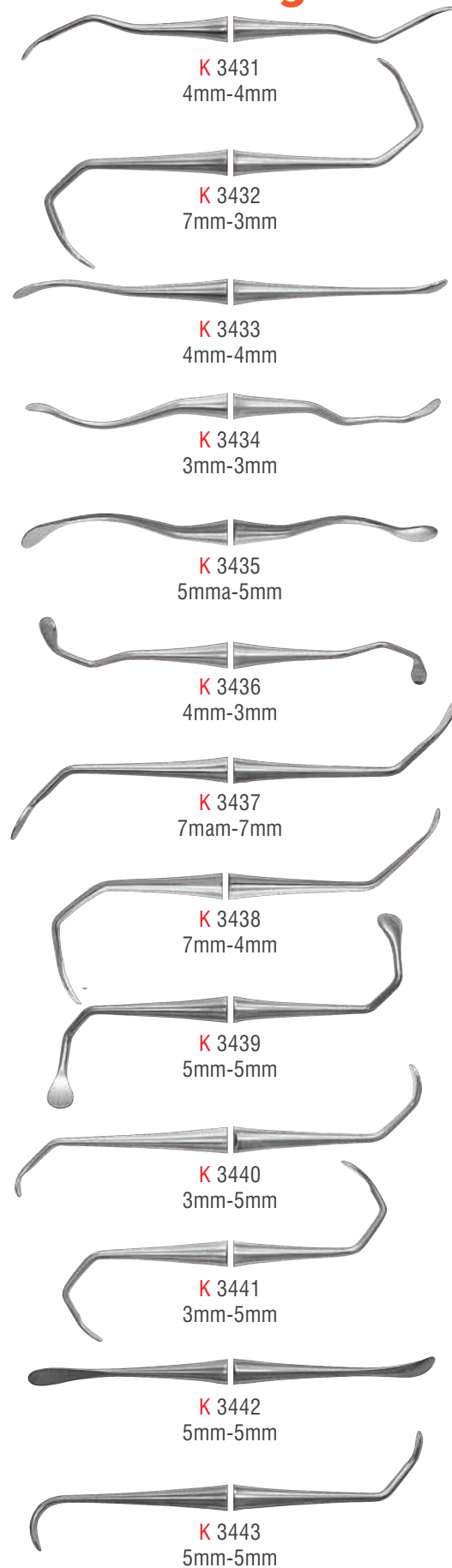

## Osteotomes with Stop Concave

استوتوم



Red F 901.122 2.2 mm	Green F 901.128 2.8 mm	Blue F 901.135 3.5 mm	Purple F 901.142 4.2 mm	Black F 901.148 4.8 mm	Red F 911.122 2.2 mm	Green F 911.128 2.8 mm	Blue F 911.135 3.5 mm	Purple F 911.142 4.2 mm	Black F 911.148 4.8 mm
----------------------------	------------------------------	-----------------------------	-------------------------------	------------------------------	----------------------------	------------------------------	-----------------------------	-------------------------------	------------------------------

## Osteotomes with Stop Convex

بن اکسپندر



Red F 931.122 1.5-2.2 mm	Green F 931.128 2.2-2.8 mm	Blue F 931.135 2.8-3.5 mm	Purple F 931.142 3.5-4.2 mm	Black F 931.148 4.2-4.8 mm	Red F 936.122 1.5-2.2 mm	Green F 936.128 2.2-2.8 mm	Blue F 936.135 2.8-3.5 mm	Purple F 936.142 3.5-4.2 mm	Black F 936.148 4.2-4.8 mm
--------------------------------	----------------------------------	---------------------------------	-----------------------------------	----------------------------------	--------------------------------	----------------------------------	---------------------------------	-----------------------------------	----------------------------------



## Osteotomes with Stop Concave

استوتوم



Blue K 3310 2.2 mm	Green K 3311 2.7 mm	Red K 3312 3.2 mm	Purple K 3313 3.7 mm	Black K 3314 4.2 mm	Yellow K 3315 4.7 mm	Blue K 3316 2.2 mm	Green K 3317 2.7 mm	Red K 3318 3.2 mm	Purple K 3319 3.7 mm	Black K 3320 4.2 mm	Yellow K 3321 4.7 mm
--------------------------	---------------------------	-------------------------	----------------------------	---------------------------	----------------------------	--------------------------	---------------------------	-------------------------	----------------------------	---------------------------	----------------------------

## Osteotomes with Stop Convex

بن اکسپندر



Blue K 3360 2.2-2.7mm	Green K 3361 2.7-3.2mm	Red K 3362 3.2-3.7mm	Purple K 3363 3.7-4.2mm	Black K 3364 4.2-4.7mm	Blue K 3365 2.2-2.7mm	Green K 3366 2.7-3.2mm	Red K 3367 3.2-3.7mm	Purple K 3368 3.7-4.2mm	Black K 3369 4.2-4.7mm
-----------------------------	------------------------------	----------------------------	-------------------------------	------------------------------	-----------------------------	------------------------------	----------------------------	-------------------------------	------------------------------



13K/TG | K 1754 T | Tin Coated | Inner



13K/TG | K 1755 T | Tin Coated | Outer



13K/TG | K 1754 | Fig 2 | Inner



13K/TG | K 1755 | F 028.135 | Fig 1 | Outer



13K/13KL | K 1756 | F 040.365



Back Action | K 1757



Chisel Hatchet | F 340.525 | Fig 51/52



Straight Chisel | K 1753 | Fig 2



Gardner | F 055.010 | 3 mm



Gardner | F 055.020 | 4 mm



Wakefield | F 070.010 | 2.7 mm



Wakefield | F 070.020 | 3 mm



Ochenbein | F 078.010 | Fig. 1



Ochenbein | F 078.020 | Fig. 2

## Periodontal Files

بن فایل بین دندانی

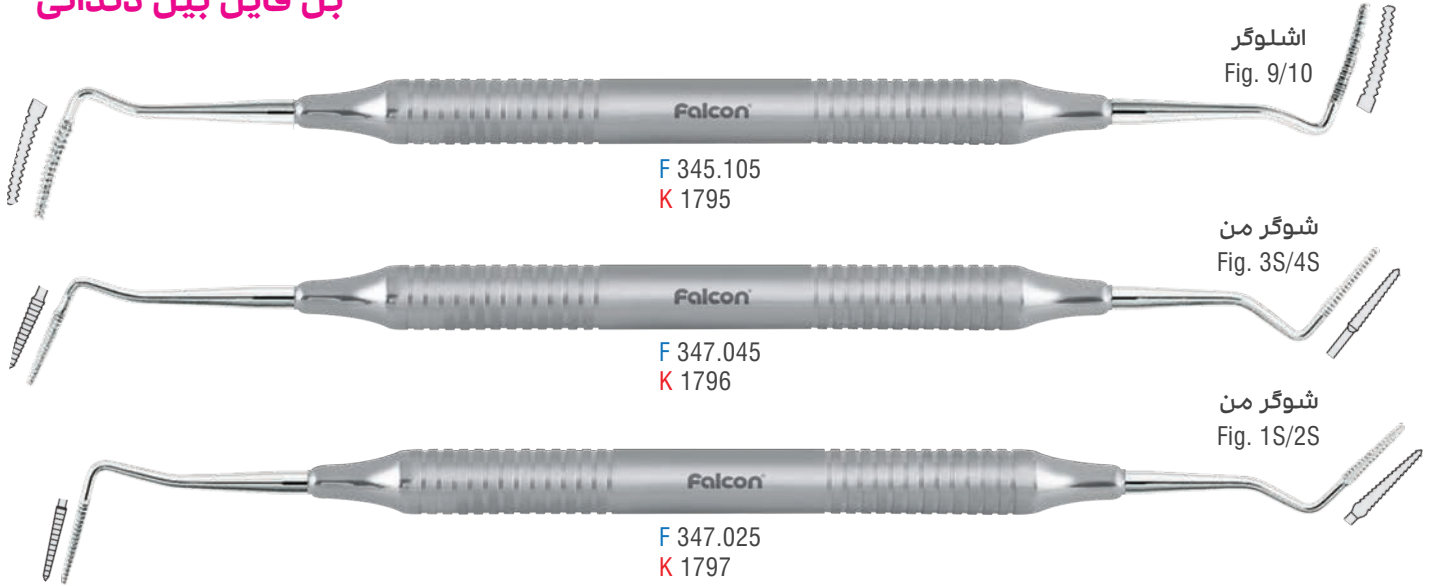

## Bone Files

بن فایل میلر

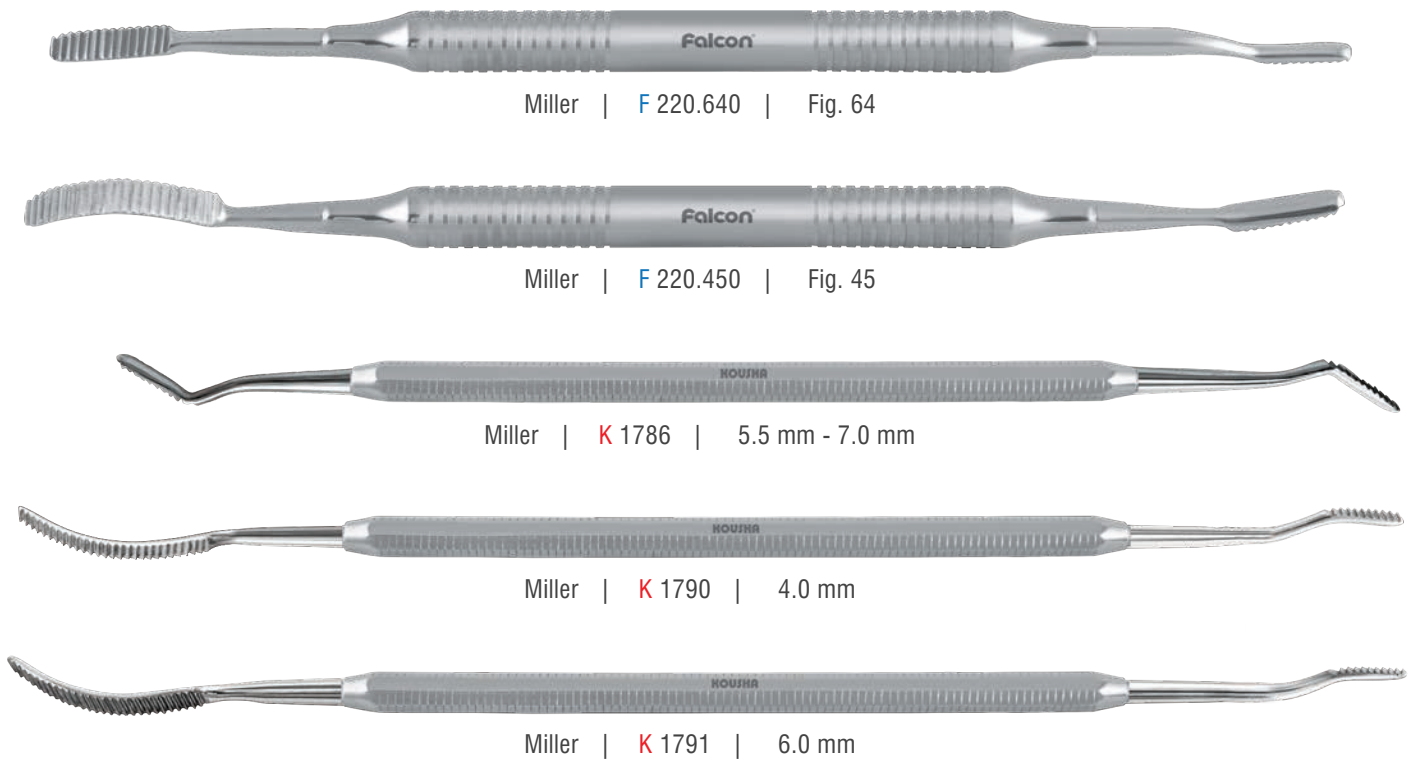

## Knife Gingivectomy

چاقوهای جراحی

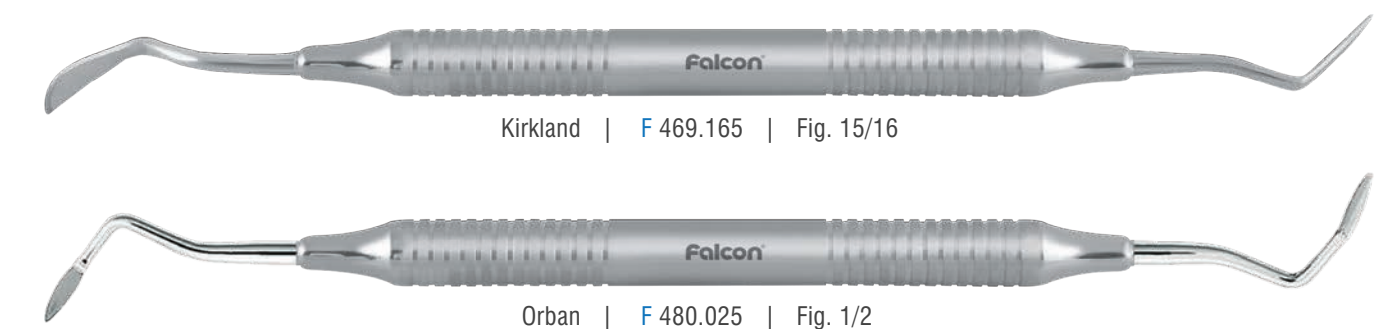

## Bone Curettes Hemingway

کورت قاشقی

دسته ساده



Hemingway | F 100.017 | K 1737 | Fig. 1

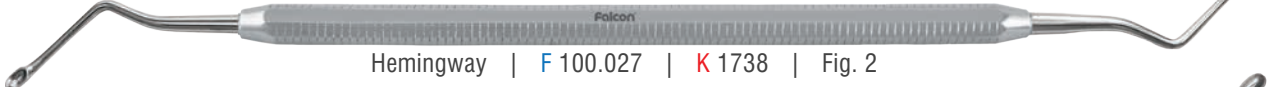

Hemingway | F 100.027 | K 1738 | Fig. 2

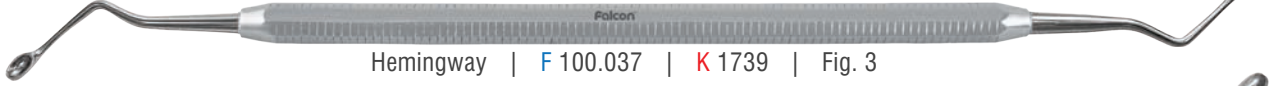

Hemingway | F 100.037 | K 1739 | Fig. 3



Hemingway | F 100.047 | K 1740 | Fig. 4

دسته هالو



Hemingway Hallow Handle | F 100.015 | Fig. 1



Hemingway Hallow Handle | F 100.025 | Fig. 2



Hemingway Hallow Handle | F 100.035 | Fig. 3



Hemingway Hallow Handle | F 100.045 | Fig. 4

## Bone Curettes Lucas

کورت لوکاس

دسته ساده

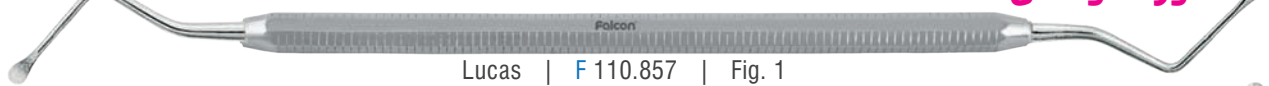

Lucas | F 110.857 | Fig. 1



Lucas | F 110.867 | Fig. 2



Lucas | F 110.877 | Fig. 3



Lucas | F 110.887 | Fig. 4

دسته هالو



Lucas Hallow Handle | F 110.855 | Fig. 1



Lucas Hallow Handle | F 110.865 | Fig. 2



Lucas Hallow Handle | F 110.875 | Fig. 3



Lucas Hallow Handle | F 110.885 | Fig. 4

## Endodontic Retractors

رترکتور های اندودنتیک



10 mm | Fig. 1  
F 488.014



10 mm | Fig. 2  
F 488.024



15 mm | Fig. 3  
F 488.034

## Molt Retractor

دهان باز کن مولت



Small | 100 mm  
F 065.100 | K 2979



Medium | 110 mm  
F 065.110 | K 2980



Large | 140 mm  
F 065.140 | K 2981

## Mallets

چکش



F 273.190 | K 2211



Partsch  
F 270.190



Mead  
F 435.190

## Rongeurs

رانژور

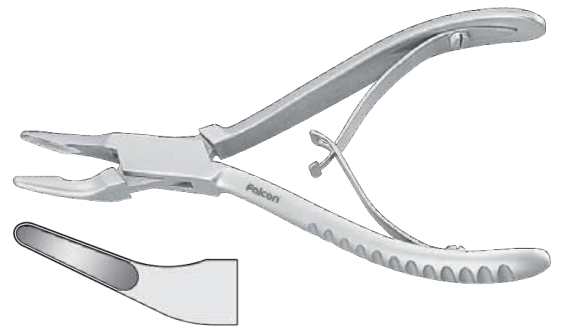

Friedman-Mini | 125 mm  
F 740.125 | K 2225



Friedman | 140 mm  
F 741.140 | K 2226

## Retractors رترکتور



مینه سوتا  
F 416.010  
K 2901



نپ گیر  
F 310.200  
200 mm



رترکتور یک سر  
F 435.010  
105 mm



رترکتور دو سر  
F 435.020  
105 mm



فارا بوف بزرگ  
F 250.150  
K 2906



فارا بوف کوچک  
F 250.120  
K 2905



راکس  
F 330.150  
150 mm



زبان گیر  
F 298.010  
140 mm



کلمبیا  
F 389.145  
145 mm



استرانبرگ | F 430.010 | 120 mm  
استرانبرگ | F 430.020 | 140 mm  
استرانبرگ | F 430.030 | 150 mm



رترکتور لب و گونه  
F 848.050  
200 mm

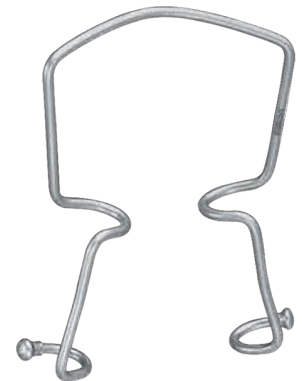

اورینگ  
F 427.031  
Set of 3 pieces

## Castroviejo Needle Holders

سوزنگیر های کاستویجو  
با روکش تنگستن کارباید



## Castroviejo Needle Holders

سوزنگیر های کاستویجو



## Micro Scissors

قیچی های میکرو

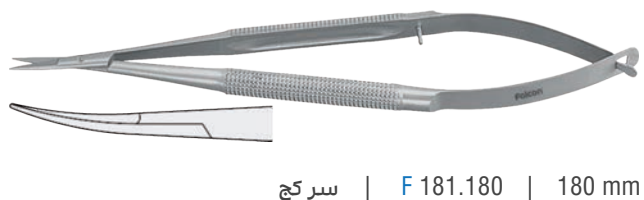
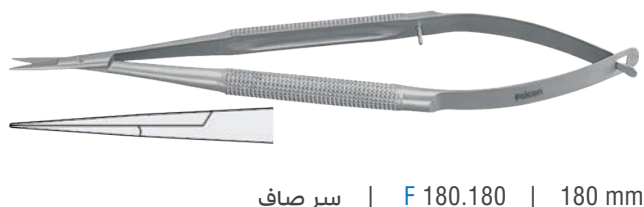
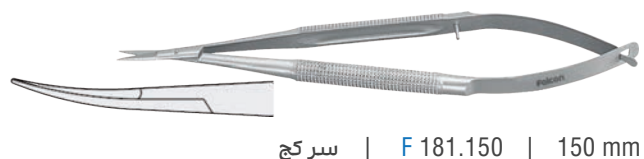

## Castroviejo Scissors

قیچی های کاستویجو

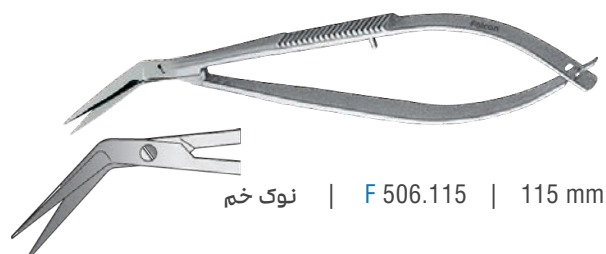
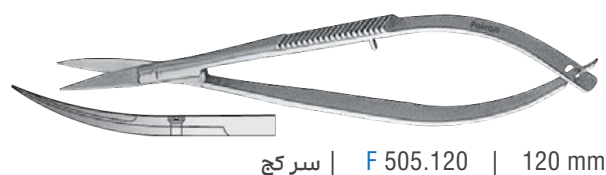
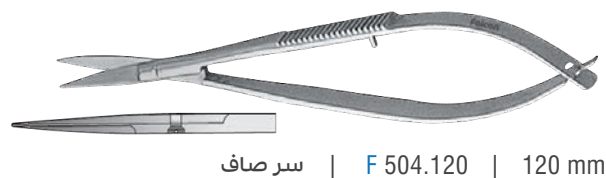

## Iris Scissors

ایریس سر صاف

F 540.115

K 2021

115 mm

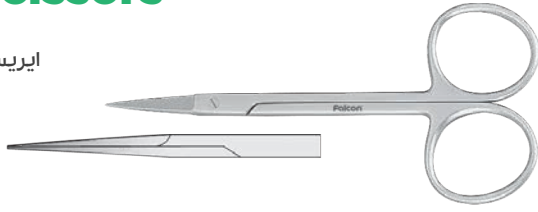

ایریس سر کج

F 541.115

K 2022

115 mm

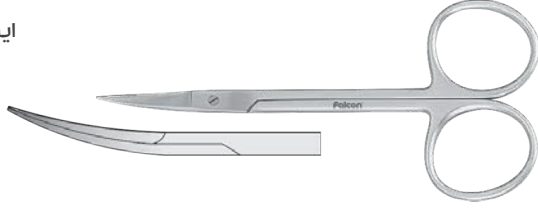

ایریس

دسته خم دار

(La grange)

F 549.115

K 2025

115 mm



## Goldman Fox Scissors

جراحی سر صاف

F 536.010

K 2010

130 mm

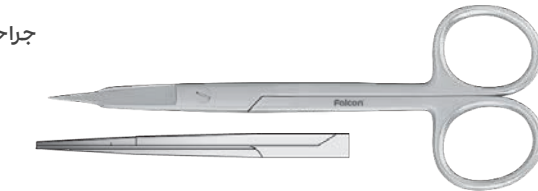

جراحی سر کج

F 537.010

K 2011

130 mm

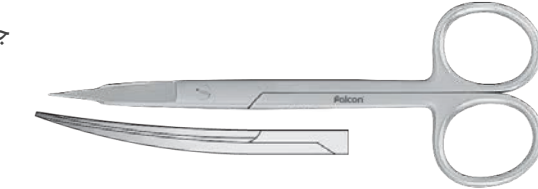

جراحی دسته خم دار

F 539.010

130 mm

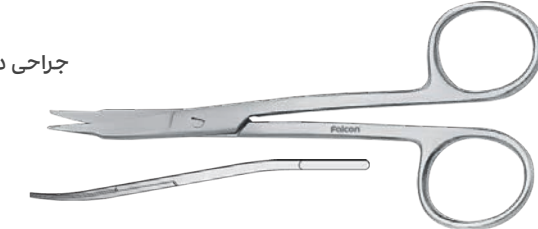

## Metzenbaum Scissors

متز سر صاف

F 762.145 | 145 mm

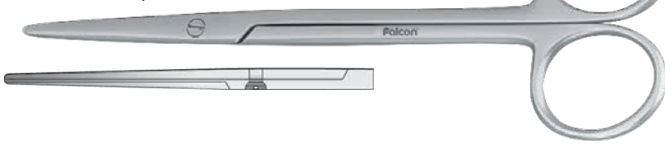

متز سر کج

F 763.145 | 145 mm



## Iris with Tungsten Carbide

TC ایریس سر صاف با روکش

F 100.115 | 115 mm

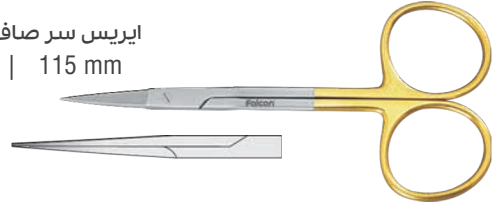

TC ایریس سر کج با روکش

F 101.115 | 115 mm



## Goldman Fox with Tungsten Carbide

TC جراحی سر صاف با روکش

F 600.130 | 130 mm

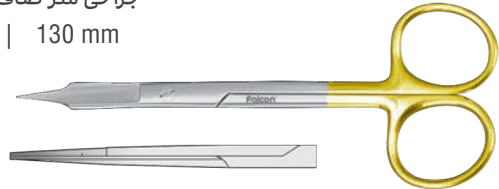

TC جراحی سر کج با روکش

F 601.130 | 130 mm

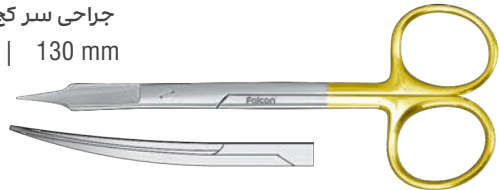

## Scissors, one Blade Serrated

دندانه دار سر صاف

F 536.011 | 130 mm



دندانه دار سر کج

F 537.011 | 130 mm



## Crown Scissors

قچی کراون بر سر صاف

F 920.120 | 120 mm



قچی کرون بر سر کج

F 921.120 | 120 mm

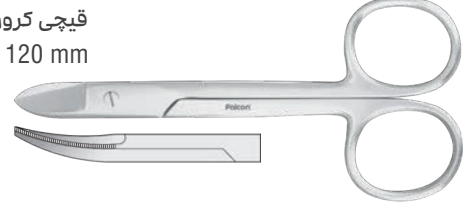



## Scalpel Handles

### دسته تیغ



F 550.030 | دسته بیستوری شماره ۳  
K 2204  
For scalpel blades no: 10, 11, 12, 12D, 13, 15, 15C



F 552.030 | Fig. 3 G | دسته بیستوری مدرج شماره ۳



F 650.040 | Fig. 4 | دسته بیستوری شماره ۴  
For blades no : 20, 21, 22, 23, 24, 25

## Stieglitz Forceps

### سوزنگیر های نوک تیز

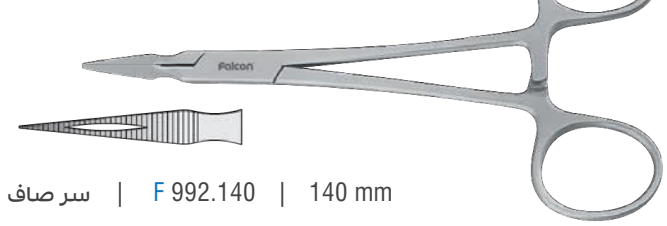

سر صاف | F 992.140 | 140 mm

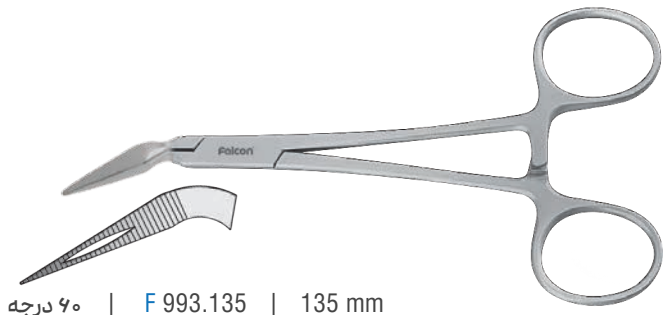

۹۰ درجه | F 993.135 | 135 mm

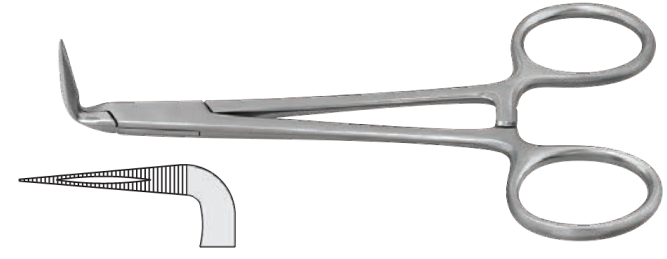

۹۰ درجه | F 994.125 | 125 mm

## Suture Forceps



پنس بخیه  
F 650.160 | 160 mm

## Dissecting and Tissue Forceps

### پنس جراحی



F 370.120 | پنس آدسون کوچک  
K 1393  
120 mm



K 1394 | پنس آدسون کوخری  
120 mm



F 370.150 | پنس آدسون بزرگ  
150 mm



F 500.145 | پنس مستقیم  
K 1380  
145 mm  
متوسط



F 502.145 | پنس مستقیم  
K 1375  
145 mm  
باریک



F 750.145 | پنس مستقیم  
K 1390  
145 mm  
کوخری متوسط



F 750.130 | پنس مستقیم  
K 1389  
145 mm  
کوخری باریک

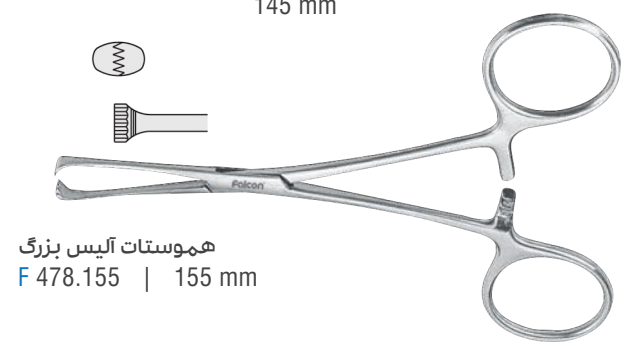

هموستات آلیس بزرگ  
F 478.155 | 155 mm

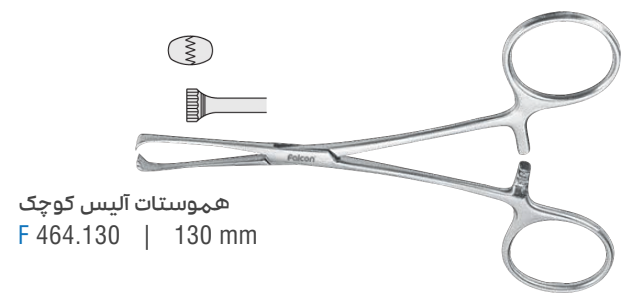

هموستات آلیس کوچک  
F 464.130 | 130 mm

## Needle Holders

سوزنگیر کوچک

F 598.130 | 130 mm



سوزنگیر نازک

F 596.140

K 3163

140 mm



سوزنگیر سرکج

F 597.140

K 3164

140 mm

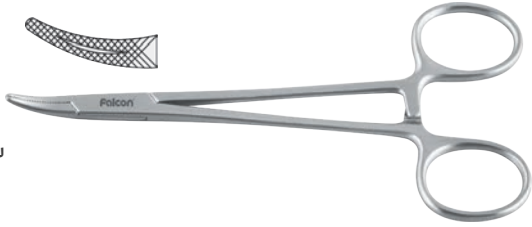

0.5 mm

TC سوزنگیر کوچک با روکش

F 298.130 | 130 mm



0.5 mm

TC سوزنگیر متوسط با روکش

F 298.140 | 140 mm

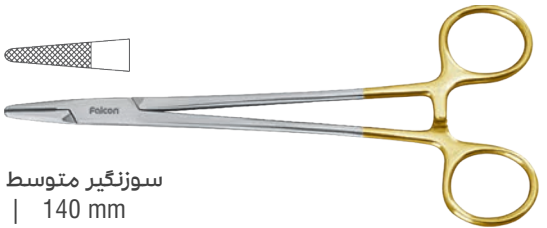

## Needle Holders Mathieu TC

0.4 mm

TC سوزنگیر متیو با روکش

F 412.140 | 140 mm



## Needle Holders Mathieu

0.4 mm

سوزنگیر متیو

F 714.140 | 140 mm



## Haemostatic Forceps

فورسپس موسکیتو سر صاف

F 224.125

K 3109

125 mm



فورسپس موسکیتو سر کج

F 225.125

K 3110

125 mm

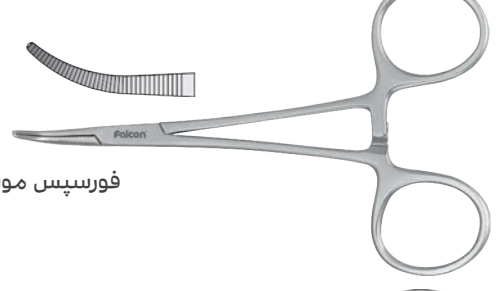

هموستات سر صاف

F 270.145

K 3010

145 mm

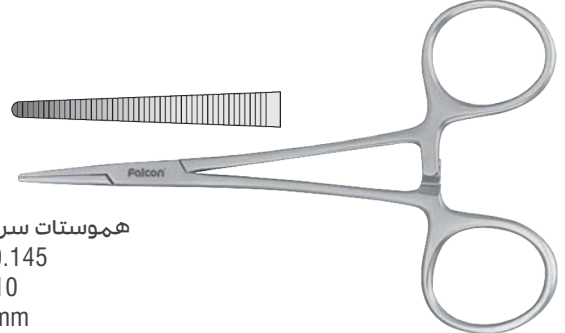

هموستات سر کج

F 271.145

K 3011

145 mm

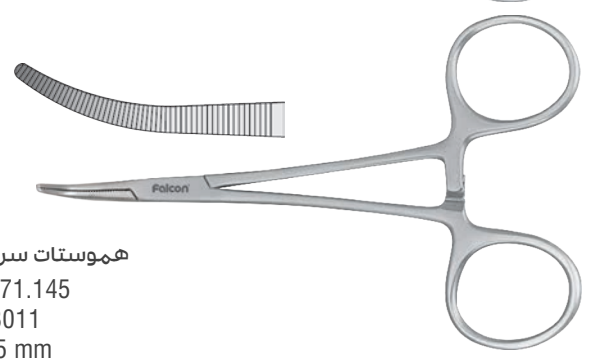

## Needle Holders Mathieu

سوزنگیر متیو

نوک استاندارد

F 392.020 | 140 mm



نوک ظریف

F 392.030 | 140 mm



## Suction Tubes

سر ساکشن های فلزی طرح فالکن



## Towel Forceps

شانگیر

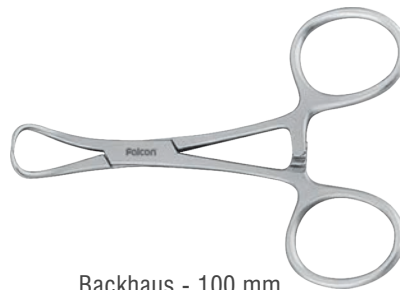

## Frazier Suction Tubes

سر ساکشن های فلزی



## Ladmore tongue deflector

سر ساکشن همراه با زبانگیر



## Bite Gauge



گیج بایت | F 001.100

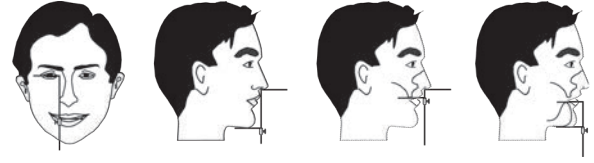

## Boley Gauges

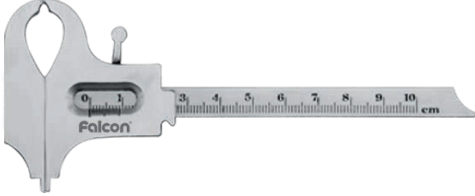

گیج اندازه گیری با قفل اهرمی | F 100.010

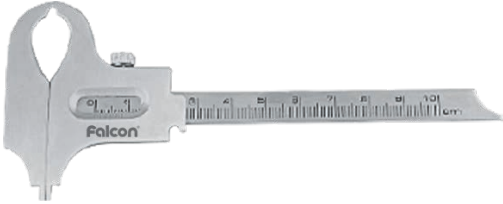

گیج اندازه گیری با قفل پیچی | F 100.020

## Calipers Iwanson



گیج فلز | F 101.010



گیج موم | F 101.020

## Plaster Cutter



قیچی گج بر سر صاف | F 325.200



قیچی گج بر سر کج | F 326.200

## Wax Modeling Carvers

اسپاتول لکرون مینی



Lecron-mini | F 882.020 | Fig. 2 | 130 mm

اسپاتول لکرون



Lecron | F 880.020 | K 2728 | Fig. 2 | 165 mm

وکس کارور هایلن

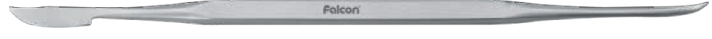

Hylin | F 875.010 | K 2727 | Fig. 1 | 135 mm

اسپاتول وکساب زاهله



Zahle | F 945.060 | K 2726 | Fig. 6 | 115 mm

## Ceramic Sculpturing Instruments

اسپاتول پودرگذاری  
(باسر قابل تعویض)



F 955.010



F 955.020



F 955.030



F 955.000 | ست سه عددی

**P.K. Thomas Instruments**

قلم های پی کی توماس

دسته ساده



F 900.017 | Fig. 1



F 900.027 | Fig. 2



F 900.037 | Fig. 3



F 900.047 | Fig. 4



F 900.057 | Fig. 5

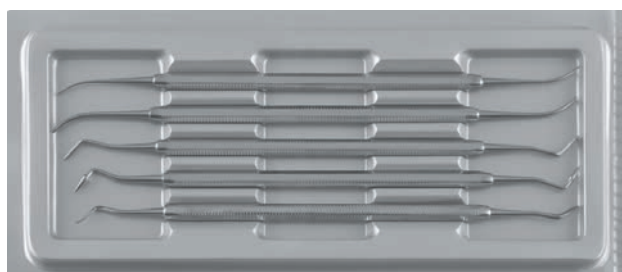

ست پی کی توماس دسته هشت گوش ۵ عددی

F 900.007 | Set of 5

**Aluminum Handle**

دسته آلومینیومی



F 905.010 | Fig. 1



F 905.020 | Fig. 2



F 905.030 | Fig. 3



F 905.040 | Fig. 4



F 905.050 | Fig. 5

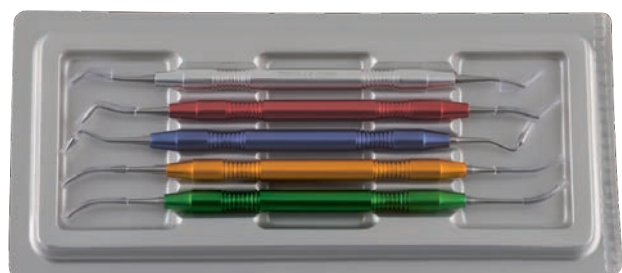

ست پی کی توماس دسته آلومینیومی ۵ عددی

F 905.000 | Set of 5

**Plaster Spatulas**

همزن های دسته چوبی

نازی



Rigid | F 451.040 | Fig. 4 | 200 mm

پهن



Rigid | F 451.050 | Fig. 5 | 215 mm

ساده



Rigid | F 451.060 | K 2701 | Fig. 6 | 210 mm

سر کج



Rigid | F 450.080 | K 2702 | Fig. 8 | 210 mm

**Plaster Knives**

چاقوهای کج



F 330.010 | 180 mm



F 335.170 | 170 mm



F 335.160 | 160 mm

**Wax Knives, Wooden Handle**

چاقوی موم | Fahnenstock | F 815.020 | K 2713 | 175 mm



چاقوی موم | Fahnenstock | F 815.010 | K 2712 | 130 mm



اسپاتول موم | Lessmann | F 825.020 | K 2711 | 175 mm



اسپاتول موم | Lessmann | F 825.010 | K 2710 | 130 mm

## Bone Expalder

بن اکسپنڈر

K 3495



## Band Pusher

بند پوشر



F 120.010 | Mershon

## Band Seating Instrument

بند سیتر (قابل اتوکلاو)



F 125.010

## Bracket Positioning Gauge

گیج های ارتفاع



F 205.018 | For .018" Slot brackets



F 205.022 | For .022" Slot brackets

## Bracket Gauge

گیج براکت ستاره ای



F 200.010 | Boone

## Bracket Placing Tweezers

پنس های براکت



F 210.135 | 135 mm



F 217.135 | 135 mm



F 220.110 | 110 mm

## پنس های براکت تیغه دار



F 213.135 | Fig. 1 | 135 mm



F 214.135 | Fig. 2 | 135 mm



F 215.135 | Fig. 3 | 135 mm

## Buccal Tube Tweezers

پنس های باکال تیوب



F 227.120 | 120 mm



F 228.125 | 125 mm

## Elastmeric Ligature Removing Tweezers

پنس برداشتن لیگاچرالاستیک



F 285.010 | 140 mm

## Elastomeric Separators Placing Pliers

پلایر



پلایر سپراتور سر کج  
F 271.165  
165 mm Curved

## Band Removing Pliers



پلایر بند ریمور  
F 492.700

## Bracket Removing Pliers Straight



پلایربراکت ریمور سر صاف  
F 511.700

## Hard Wire Cutters



ساید کاتر  
F 777.300

## Plier Stands



جای پلایر  
F 964.030

## Mini Distal End Cutter With Safety Hold



دیسیتال اندکاتر  
F 536.700

●	0.30 mm to 0.50 mm (.012" to .020")
■	Max. 0.46 mm x 0.64 mm (.018" x .025")
⊗	0.38 mm to 0.53 mm (.0155" to .0215")
⊗	Max. 0.53 mm x 0.64 mm (.021" x .025")

## Hard Wire Cutter Straight



هارد وایر کاتر سر صاف مخصوص سیم های سخت  
F 550.700

●	0.30 mm to 0.50 mm (.012" to .020")
■	Max. 0.56 mm x 0.71 mm (.022" x .028")

## Soft Wire And Ligature Cutter Standard



لیگاچر کاتر سر صاف مخصوص سیم های نرم  
F 574.700

⌋	.25 mm to .38 mm (.010" to .015")
---	-----------------------------------

## Loop Forming Pliers



پلایر نانس  
Nance | F 688.700

●	0.36 mm to 0.71 mm (.014" to .028")
■	Max. 0.56 mm x 0.71 mm (.022" x .028")

## 3-Jaw Wire Bending Pliers



پلایر سه شاخ  
F 585.700

●	0.30 mm to 0.50 mm (.012" to .020")
■	Max. 0.56 mm x 0.71 mm (.022" x .028")

## Utility Pliers

پلاير



پلاير وينگارڊ

●	0.30 mm to 0.50 mm (.012" to .020")
■	Max. 0.56 mm x 0.71 mm (.022" x .028")

Weingart

F 738.700



پلاير هاو سر صاف

●	0.30 mm to 0.50 mm (.012" to .020")
■	Max. 0.56 mm x 0.71 mm (.022" x .028")

How

F 664.700

## Bands Or Crowns Contouring Pliers For Contouring And Adapting



پلاير نوک مرغی

Gordon

F 460.300 N



پلاير جانسون

Gordon

F 465.300

## Angular Atch Forming And Torquing Pliers (Ribbon Arch Pliers)

## Rectangular Atch Forming And Torquing Pliers (Ribbon Arch Pliers)



پلاير آرچ فورمينگ

F 616.300

## Wire Bending Pliers



پلاير ۱۳۹

Angle round/Flat

F 812.300 N



پلاير يونيورسال

Adams

F 795.300 N

## Arch Forming And Contouring Pliers



De la Rose

پلاير دلا روزا

F 602.300

## Surgical Ball Hook Crimping Pliers



پلاير کریمپبل هوک سرصاف

F 621.700



## Sterilization Cassettes

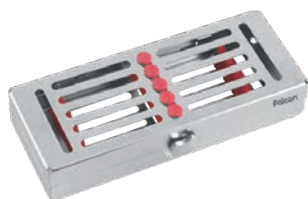

سینی جراحی سیلیکون دار ۵ عددی  
F 085.013  
K 7000  
Stainless steel for 5 instruments  
182 x 72 x 34 mm



سینی جراحی سیلیکون دار ۱۰ عددی  
F 085.023  
K 7004  
Stainless steel for 10 instruments  
182 x 144 x 34 mm



سینی جراحی سیلیکون دار ۲۰ عددی  
F 085.033  
K 7005  
Stainless steel for 20 instruments  
288 x 182 x 34 mm

## Instrument Trays Stainless Steel



سینی دریدار سوراخ دار  
F 431.000  
K 2558  
Perforated, 288 x 187 x 40 mm

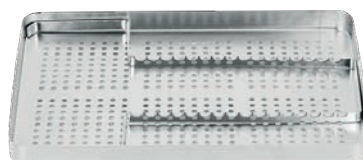

سینی بدون درب سوراخ دار  
F 430.030 S  
K 2550  
Perforated, 288 x 187 x 40 mm



سینی بدون درب بدون سوراخ  
F 430.040 S  
K 2549  
Solid, 288 x 187 x 40 mm

## Instrument Trays Stainless Steel



سینی معاینه کوچک  
F 420.020  
K 2542  
Small, 190 x 100 x 17 mm



سینی معاینه متوسط  
F 420.021  
K 2543  
Medium, 190 x 135 x 17 mm



سینی معاینه بزرگ  
F 420.022  
K 2544  
Large, 290 x 215 x 17 mm

## Instrument Trays Stainless Steel



دیش دریدار کوچک  
F 224.150  
K 2554  
Small, 230 x 150 x 50 mm



دیش دریدار متوسط  
F 227.200  
K 2555  
Medium, 250 x 200 x 50 mm



دیش دریدار بزرگ  
F 230.200  
K 2556  
Large, 300 x 200 x 50 mm

## Forceps Jars Stainless Steel

چیتل



F 755.110 - 110mm.50mm  
K 2523 - 110mm.50mm



F 755.130 - 130mm.50mm  
K 2524 - 165mm.50mm



F 760.110 - 110mm.75mm  
K 2525 - 130mm.75mm



F 760.130 - 130mm.75mm

## Kidney Trays Stainless Steel

رسیور



F 570.150  
K 2533  
Small 150 mm



F 570.180  
K 2534  
Medium 180 mm



F 570.200  
K 2535  
Large 200 mm

## Drums Stainless Steel

بیگس گاز



K 2592  
Extra Small 90 x 90 mm



F 850.125  
K 2593  
Small 125 x 125 mm



F 850.140  
K 2594  
Medium 140 x 140 mm



F 850.150  
K 2595  
Large 150 x 150 mm

## Gallipots Stainless Steel

گالی پات



F 600.010  
K 2572  
30 cc



F 600.020  
K 2573  
60 cc



F 600.030  
K 2574  
90 cc



F 600.040  
K 2575  
120 cc



F 600.060  
K 2576  
150 cc



F 600.080  
K 2577  
180 cc

## Cotton Dispensers Stainless Steel

جای پنبه فنردار آلومینیومی



F 535.010



F 535.020



F 535.030



F 535.040



F 535.050

## Cotton Container Stainless Steel

جای پنبه دربردار



4 x 4 inch  
K 2566



3 x 3 inch  
K 2565



جای پنبه گلوله ای  
F 532.000  
K 2563



جای پنبه فنردار  
F 540.020  
K 2561



جای پنبه ستاره ای  
F 544.010  
K 2562

## Alcohol Lamp

چراغ الکی



چراغ الکی  
ثابت  
F 010.000



چراغ الکی  
قابل تنظیم بزرگ  
F 015.020  
K 2517



چراغ الکی  
قابل تنظیم کوچک  
F 015.010  
K 2516

## Color Code Rings

حلقه علامت گذاری ابزار  
( قابل اتوکلاو )



F 080.000 Small, inner Ø 4 mm  
F 081.000 Large, inner Ø 6 mm  
Assorted colors, pack of 50 pieces

## Endo Box

اندو باکس  
مستطیلی



K 2583

## X-Ray Clip

گیره فیلم



F 970.010  
K 2502