

شرکت صنایع پزشکی ابزار جراحی
فتاح طب پویا



FattahTeb
Instruments

شرکت صنایع ابزار جراحی
فتاح طب پویا

— 1881 —



Examination Set

ست معاینه

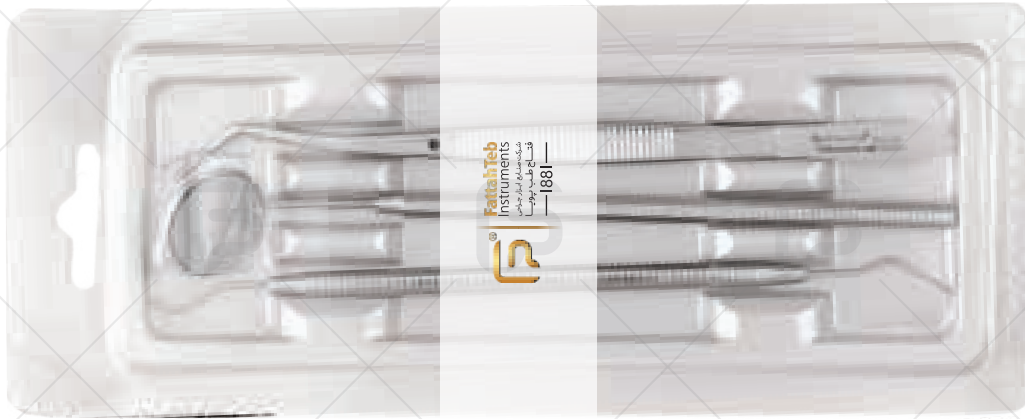

- 1400 Set of 4 Pcs ست معاینه ۴ عددی

Explorers and Probes

سوندها



- 1401 Explorers Probe D/E سوند دو سر ساده



- 1402 Explorers Hollow Probe D/E سوند دو سر هالو

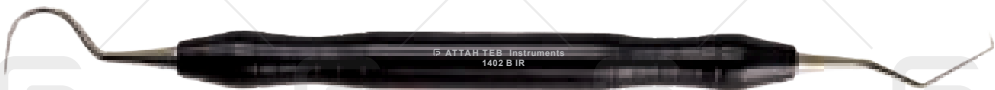

- 1402 B Explorers Hollow Probe D/E (Carbonex) سوند مشکی دو سر هالو تیتانیومی



- 1403 Probe S/E سوند داسی یکسر



- 1404 Endo Probe S/E سوند اندو بلند یکسر

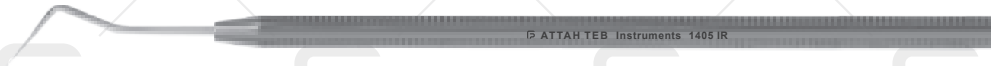

- 1405 Endo Probe سوند اندو



Mirror Handles

دسته آینه



- 1410 Mouth mirror handle دسته آینه ساده

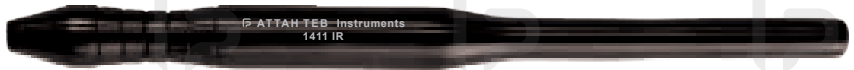

- 1411 Mouth mirror handle Hollow (Carbonex) دسته آینه مشکی هالو



- 1412 Mouth mirror handle Hollow (طرح هانینگرات) دسته آینه هالو

Mouth Mirrors

سر آینه



- Front Surface 1420 (0.22 mm) No.04
سر آینه شماره ۴ (بدون دورنما)



- Plain 1421 (0.22 mm) No.04
سر آینه شماره ۴ (ساده)

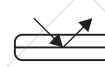

- Front Surface 1440 (0.24 mm) No.05
سر آینه شماره ۵ (بدون دورنما)



- Plain 1441 (0.24 mm) No.05
سر آینه شماره ۵ (ساده)



Tweezers

پنس ها



- 1450 Tweezer TC (Carbonex) پنس مشکی یک خم



- 1451 Tweezer Mariam پنس دو خم



- 1452 Locking tweezers پنس قفل دار



- 1453 Perry tweezers پنس گوتا



Extraction Forceps

فورسپس بزرگسال

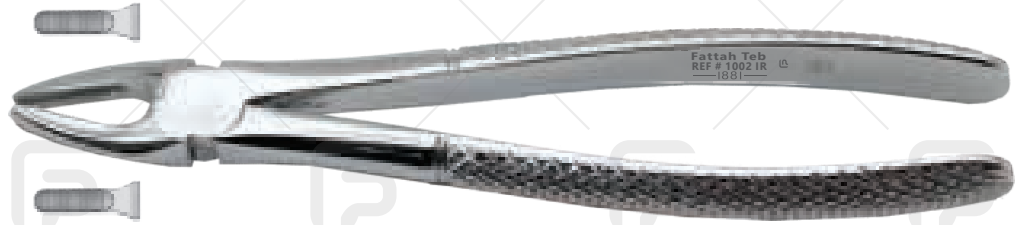

■ 1002 Fig.02 Upper incisors and Canines ساترال بال



■ 1003 Fig.07 Upper Bicuspidis پرمولر بال



■ 1004 Fig.17 Upper Molars, Right مولر بال راست



■ 1005 Fig.18 Upper Molars, Left مولر بال چپ

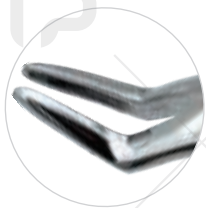

■ 1006 Fig.51 Upper Roots ریشه کش بال



Extraction Forceps

فورسپس بزرگسال



■ 1007 Fig.67 Upper Wisdom Teeth عقل بالا



■ 1008 Fig.89 Upper Molars Right کاهورن بالا راست



■ 1009 Fig.90 Upper Molars Left کاهورن بالا چپ



■ 1010 Fig.13 Lower Incisors and Bicuspidis پرمولر پایین



■ 1011 Fig.22 Lower Molars مولر پایین



Extraction Forceps

فورسپس بزرگسال



1012 Fig.33 Lower Roots ریشه کش پایین

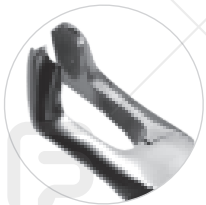

1013 Fig.79 Lower Wisdom teeth عقل پایین



1014 Fig.86A Lower Deeply Decayed Molars کاهورن پایین



1015 Fig.86C Lower Roots کاهورن پایین محدب



1019 Fig.97C Upper Roots Long Tips ریشه کش بالا بلند (ویژه)





Extraction Forceps

فورسپس بزرگسال



■ 1021 Fig.29 Upper Front Roots (ریشه کش ساترال بالا (ویژه)



■ 1023 Upper Roots (witzel) (ریشه کش بالا باریک (ویژه)



■ 1024 Upper Roots (witzel) (ریشه کش بالا (ویژه)

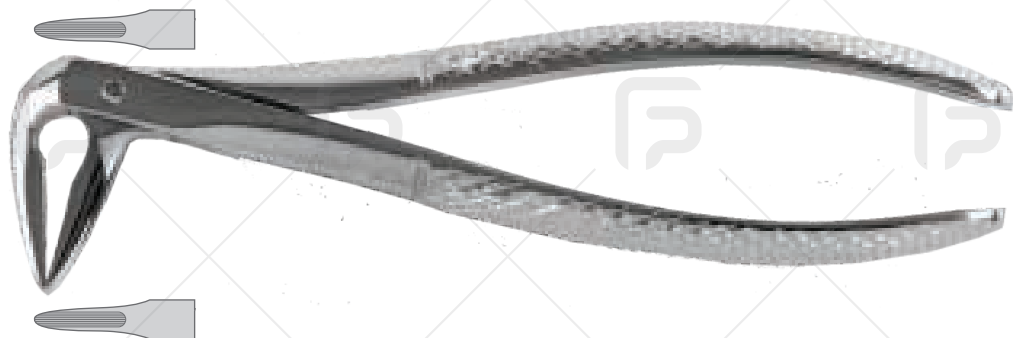

■ 1025 Fig.729 Special Pattern for Lower Roots (witzel) (ریشه کش پایین (ویژه)



■ 1026 Wisdom Teeth (عقل نهفته)



Extraction Forceps

فورسپس بزرگسال



- 1040 lower Right Molars (Routourer) مولر پایین راست



- 1041 lower Left Molars (Routourer) مولر پایین چپ



- 1042 Lower Right Roots (Routourer) کاهورن پایین راست



- 1043 Lower Left Roots (Routourer) کاهورن پایین چپ



Extraction Forceps

فورسپس بزرگسال



■ 1062 Crown Remover Forceps روکش فک پایین



■ 1063 Crown Remover Forceps روکش پلاستیکی



■ 1064 Crown Remover Forceps روکش فک بالا

■ 1000 Set of 11 Pcs Adults Forceps

ست فورسپس بزرگسال 11 عددی

1002-1003-1004
1005-1006-1007
1010-1011-1012
1013-1014



Extraction Forceps Children

فورسپس های اطفال فنردار

■ 1051 Fig.1 ساتترال بالا
Upper Incisors and Canines



■ 1052 Fig.2 پرمولر بالا چپ و راست
Upper Bicuspid (Right/Left)



■ 1053 Fig.3 مولر بالا
Upper Molars



■ 1054 Fig.4 ریشه کش بالا
Upper Roots





FattahTeb
Instruments

شرکت صنایع ابزار جراحی
فتاح طب پویا

— 1881 —

Extraction Forceps Children

فورسپس های اطفال فنردار

■ 1055 Fig.5 پرمولر پایین
Lower Incisors and Bicuspid



■ 1056 Fig.6 مولر پایین
Lower Molars



■ 1057 Fig.7 ریشه کش پایین
Lower Roots



■ 1050



ست فورسپس اطفال فنر دار ۷ عددی
Set of 7Pcs Extraction Forceps (Children)

FattahTeb
Instruments
— 1881 —



Bein Elevators Round Tips

الواتور های مستقیم

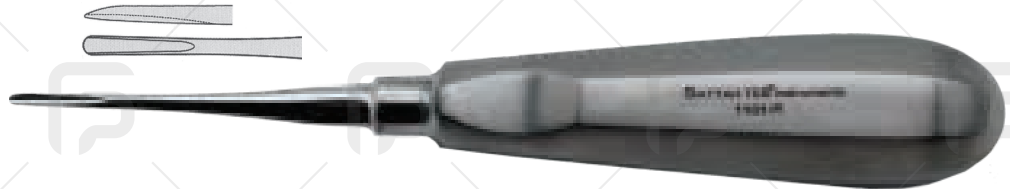

■ 1101 2mm Bein الواتور مستقیم

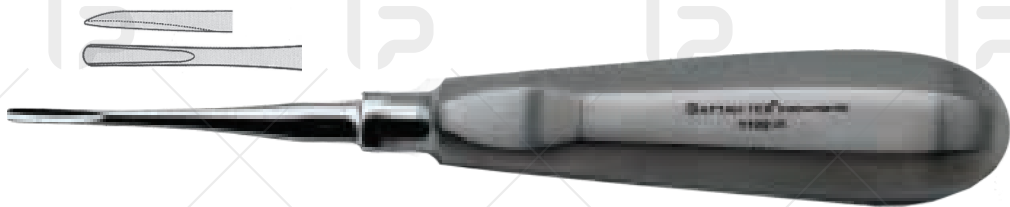

■ 1102 2.5mm Bein الواتور مستقیم

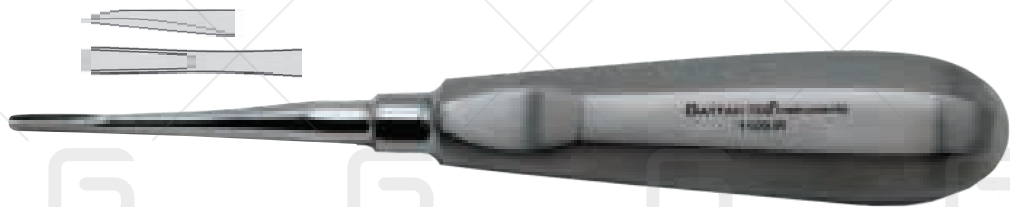

■ 1203 3mm Bein الواتور مستقیم

1103 3mm Bein

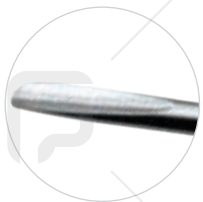

■ 1204 3.5mm Bein الواتور مستقیم

1104 3.5mm Bein



Bein Elevators Round Tips

الواتورهای مستقیم

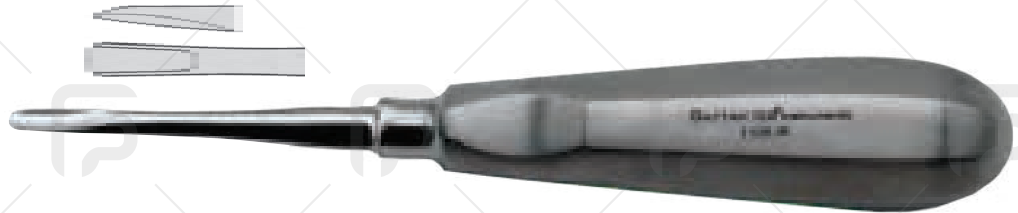

- 1205 4mm Bein الواتور مستقیم
- 1105 4mm Bein

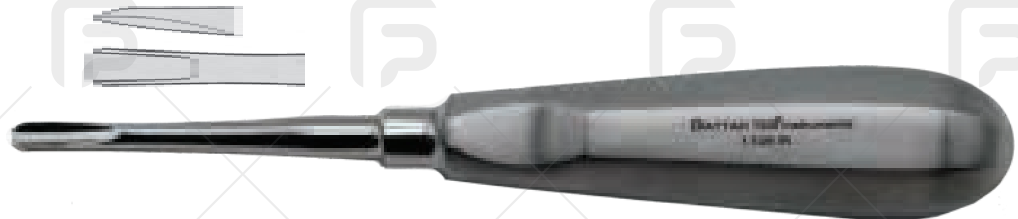

- 1206 4.5mm Bein الواتور مستقیم
- 1106 4.5mm Bein

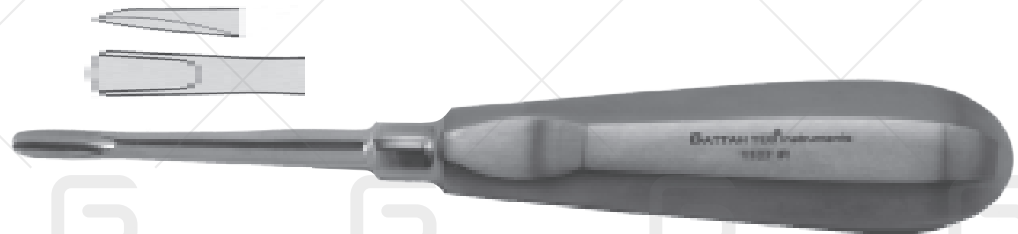

- 1207 5mm Bein الواتور مستقیم
- 1107 5mm Bein

Luxation Elevators

الواتورهای پاشنه ای

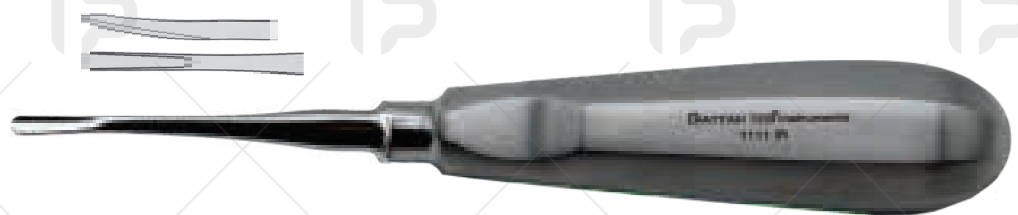

- 1211 3mm Luxation الواتور پاشنه ای
- 1111 3mm Luxation



Luxation Elevators

الواتورهای پاشنه ای



- 1212 3.5mm Luxation الواتور پاشنه ای
- 1112 3.5mm Luxation

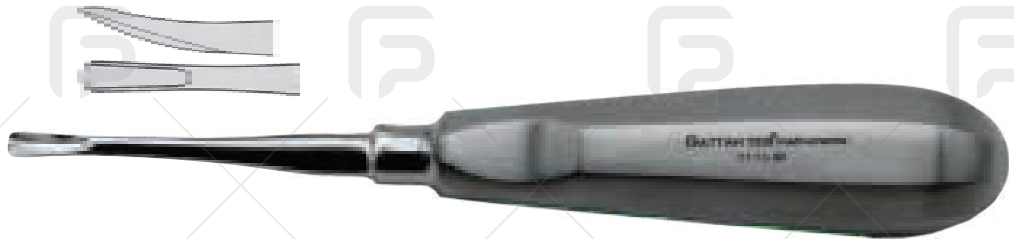

- 1213 4mm Luxation الواتور پاشنه ای
- 1113 4mm Luxation



- 1214 4.5mm Luxation الواتور پاشنه ای
- 1114 4.5mm Luxation

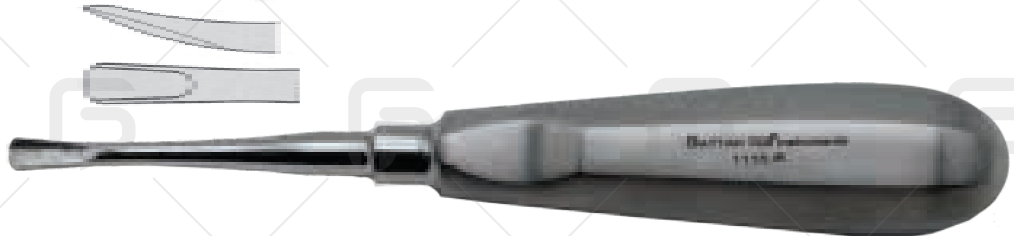

- 1215 5mm Luxation الواتور پاشنه ای
- 1115 5mm Luxation





FattahTeb
Instruments

شرکت صنایع ابزار جراحی
فتاح طب پویا

— 1881 —

Coupland Elevators

الواتورهای کوپلن

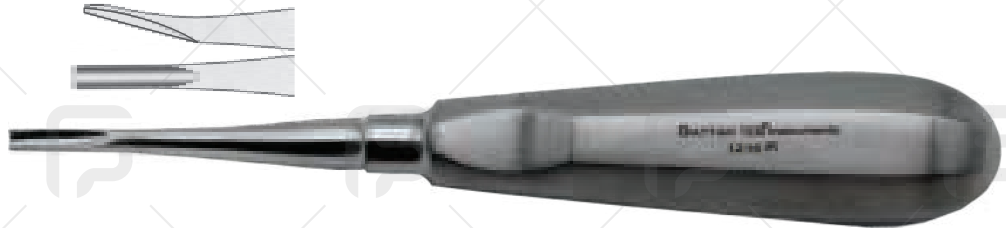
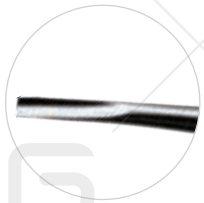

- 1216 3mm Coupland الواتور کوپلن

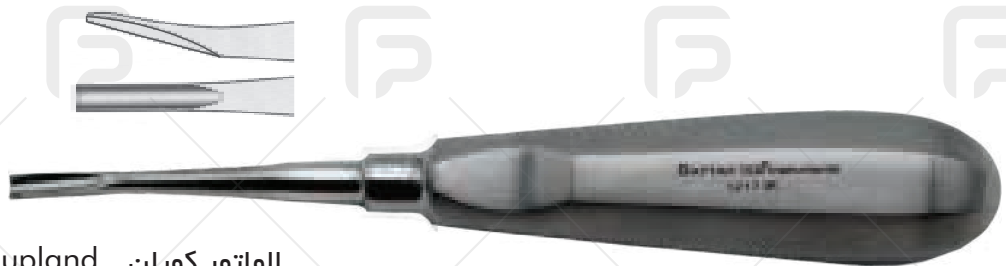

- 1217 3.5mm Coupland الواتور کوپلن

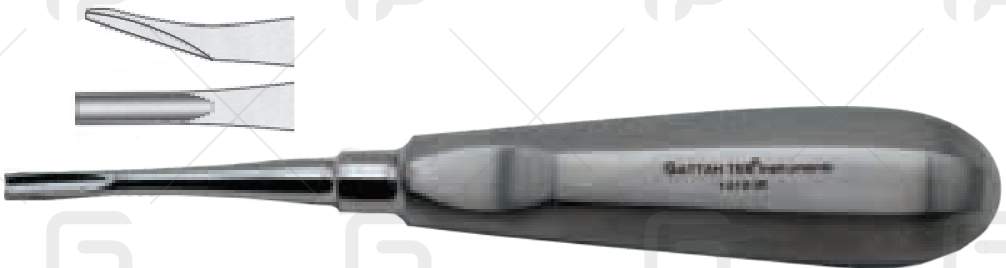

- 1218 4mm Coupland الواتور کوپلن

T-Handle Winter Elevators

الواتورهای دسته صلیبی



- 1231 10mm Right T-Handle الواتور صلیبی راست

- 1232 10mm Left T-Handle الواتور صلیبی چپ





Lendo-Levian Elevator

الواتورهای دنده ای

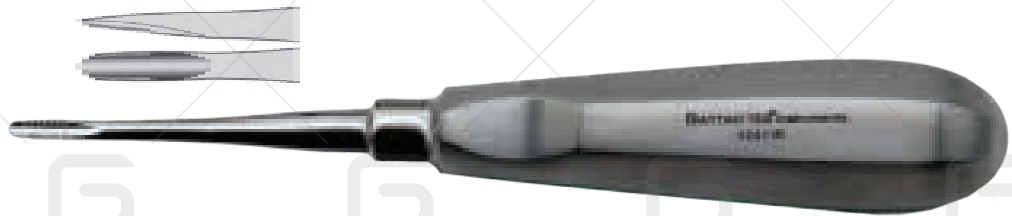

- 1241 Lendo-Levian Str الواتور دنده ای مستقیم

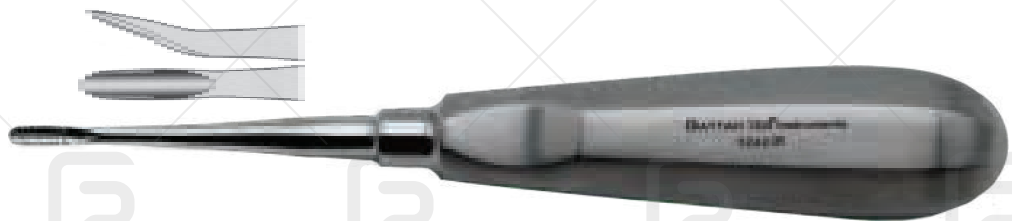

- 1242 Lendo-Levian Cvd الواتور دنده ای سر کج

Flohr Elevator

الواتورهای سوزنی

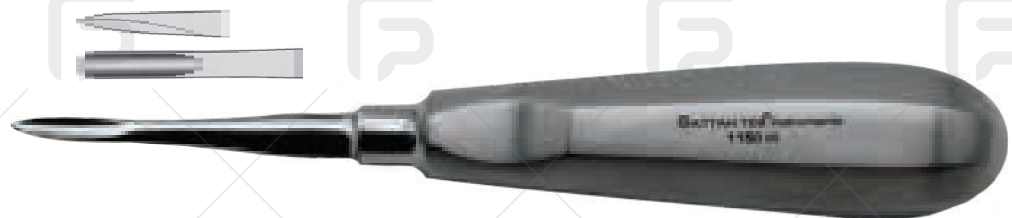

- 1250 3.5mm Bein Flohr الواتور سوزنی مستقیم

1150 3.5mm Bein Flohr

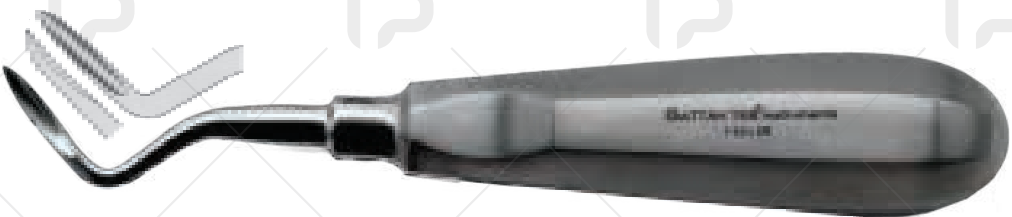

- 1251 3.5mm Right Flohr الواتور سوزنی راست

1151 3.5mm Right Flohr

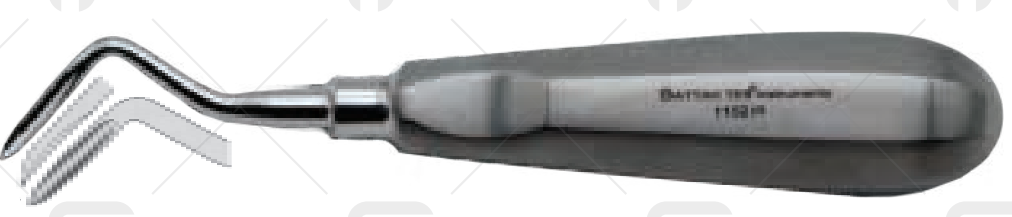

- 1252 3.5mm Left Flohr الواتور سوزنی چپ

1152 3.5mm Left Flohr



FattahTeb
Instruments

شرکت صنایع ابزار جراحی
فتاح طب پویا

— 1881 —

Apical Elevator

الواتورهای اپیکال

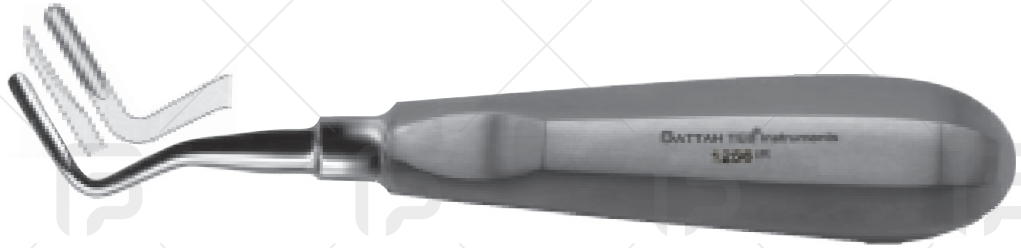

- 1256 3.5mm Right Apical الواتور اپیکال راست



- 1257 3.5mm Left Apical الواتور اپیکال چپ

Cryer Elevator

الواتورهای پرچمی

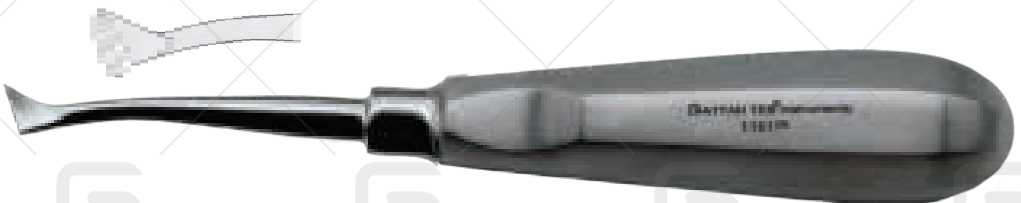

- 1261 Right Cryer الواتور پرچمی راست
- 1161 Right Cryer

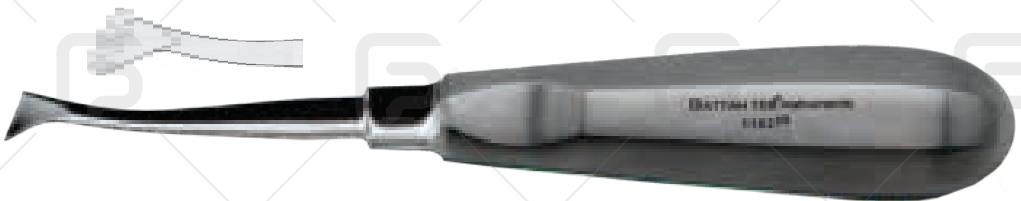

- 1262 Left Cryer الواتور پرچمی چپ
- 1162 Left Cryer



HeideBrink Elevator

الواتورهای مخصوص ریشه

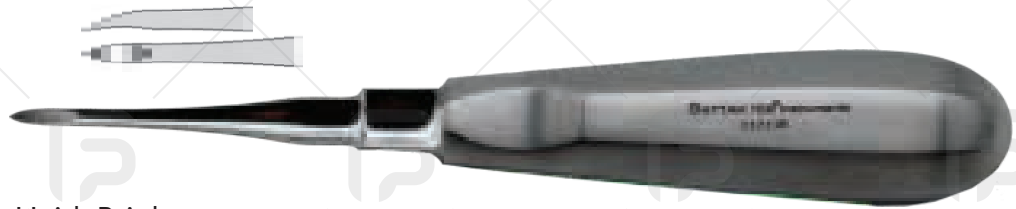

■ 1271 2.5mm Bein HeideBrink الواتور ریشه مستقیم

1171 2.5mm Bein HeideBrink

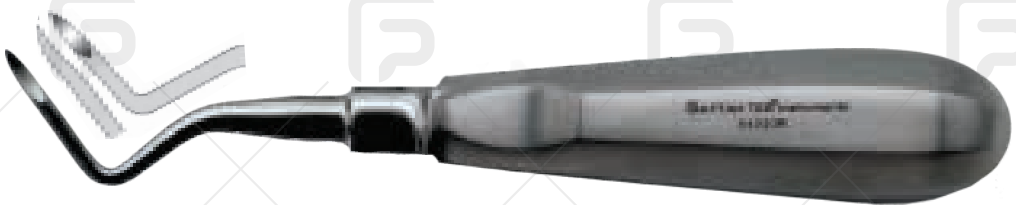

■ 1272 2.5mm Right HeideBrink الواتور ریشه راست

1172 2.5mm Right HeideBrink

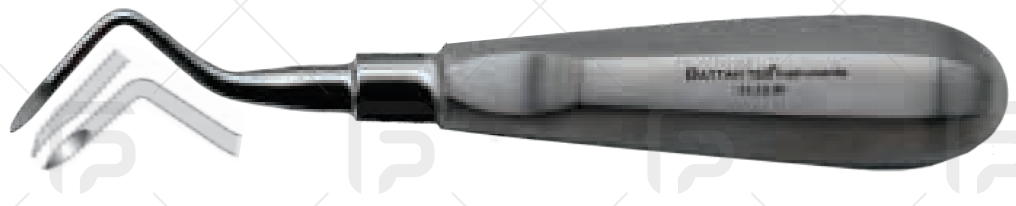

■ 1273 2.5mm Left HeideBrink الواتور ریشه چپ

1173 2.5mm Left HeideBrink



FattahTeb
Instruments

شرکت صنایع ابزار جراحی
فتاح طب پویا

— 1881 —

Warwick - James Elevator

الواتورهای اطفال



- 1281 Bein Warwick-James الواتور اطفال مستقیم



- 1282 Left Warwick-James الواتور اطفال چپ



- 1283 Right Warwick-James الواتور اطفال راست

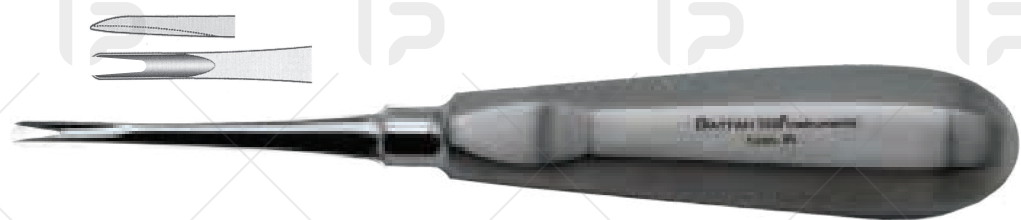

- 1285 Fork Elevator الواتور دو شاخه



Distal Elevator

الواتورهای دیستال



- 1286 Right Distal الواتور دیستال راست

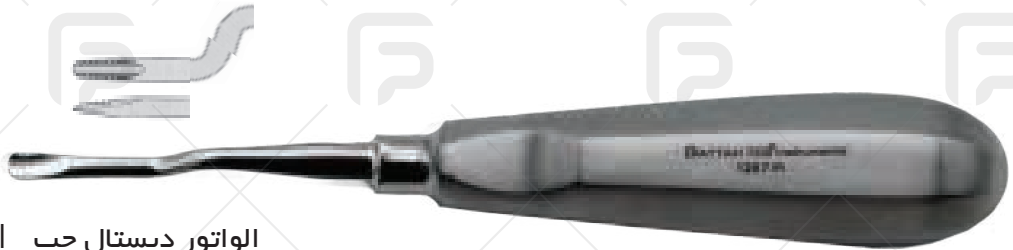

- 1287 Left Distal الواتور دیستال چپ

Elevators Set

ست الواتور

- 1200 Elevator Set of 7 Pcs (ست الواتور آلیاژ فرانسوی (۷ عددی)
French Stainless Steel
1203-1205-1212-1251-1252-1261-1262

- 1100 Elevator Set of 7 Pcs (ست الواتور ساده (۷ عددی)
Stainless Steel
1103-1105-1112-1151-1152-1161-1162





Implants Instruments

قلم های ایمپلنت

- 8500 Set of 5 Pcs Implants (ست ایمپلنت (۵ عددی)



- 8501 PDL01 Implants



- 8502 PDL02 Implants



- 8503 PDL03 Implants



- 8504 PDL04 Implants



- 8505 PDL05 Implants



- 8510 9.5 mm Implants Tweezer (Carbonex) پنس ایمپلنت سر صاف



- 8511 9.5 mm Implants Tweezer (Carbonex) پنس ایمپلنت سر کج



- 7675 Periotom D/E قلم پریوتوم طلایی دوسر

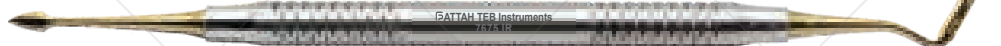

- 7676 Periotom S/E (Flexy) (Carbonex) قلم پریوتوم تیتانیوم سر صاف





Open Sinus Lift Currettes

کورت های سینوس لیفت

■ 8001 Sinus Lift

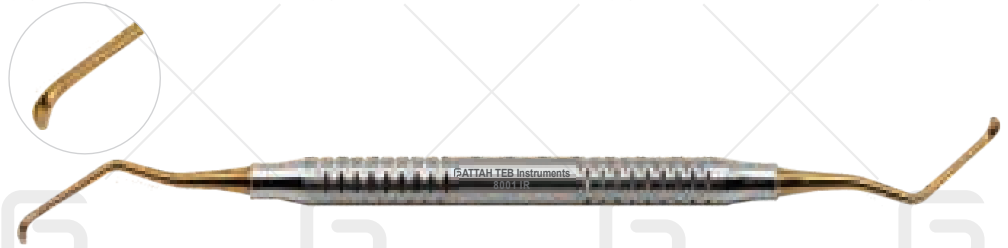

■ 8002 Sinus Lift



■ 8003 Sinus Lift



■ 8004 Sinus Lift



■ 8005 Sinus Lift



■ 8006 Sinus Lift





Osteotoms with Stop (Concave)

استوتوم ها

- 8100 Osteotoms Set Of 5 Pcs (Str) ست ۵ عددی استوتوم سر صاف

8101 2.6 mm



8102 3.1 mm



8103 3.8 mm



8104 4.5 mm



8105 5 mm



- 8200 Osteotoms Set Of 5 Pcs (Cvd) ست ۵ عددی استوتوم سر کج

8201 2.6 mm



8202 3.1 mm



8203 3.8 mm



8204 4.5 mm



8205 5 mm





Osteotoms with Stop Convex

بن اکسپندرها

■ 8300 Osteotoms Set Of 5 Pcs (Str) ست ۵ عددی بن اکسپندر سر صاف

■ 8301 2.6 mm



■ 8302 3.1 mm



■ 8303 3.8 mm



■ 8304 4.5 mm



■ 8305 5 mm



■ 8400 Osteotoms Set Of 5 Pcs (Cvd) ست ۵ عددی بن اکسپندر سر کج

Convex
Head

■ 8401 2.6 mm

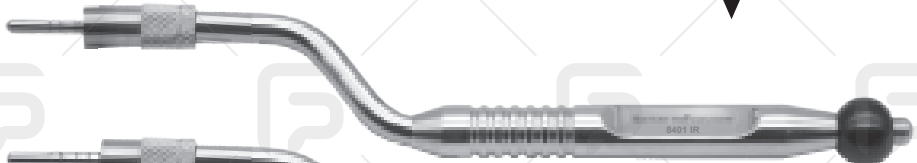

■ 8402 3.1 mm

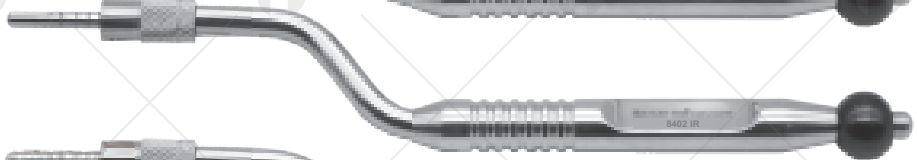

■ 8403 3.8 mm

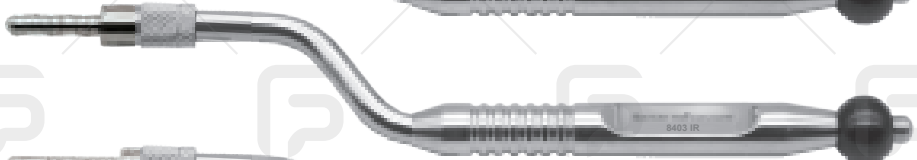

■ 8404 4.5 mm

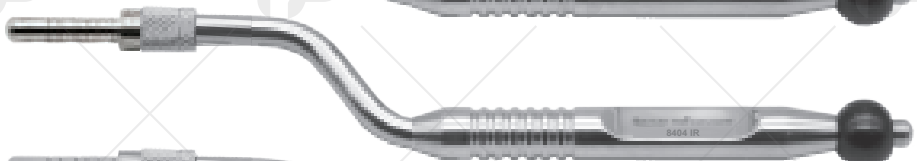

■ 8405 5 mm





Dental Surgery

جراحی دندان

Dissecting and Tissue Forceps



- 3001 Micro Adson CNC (12cm) پنس آدسون کوخر ظریف

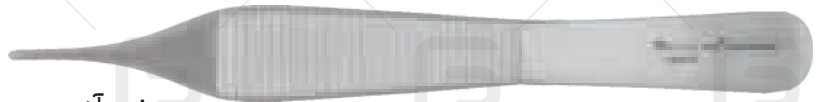

- 3002 Adson CNC (12cm) پنس آدسون مستقیم ظریف



- 3005 Adson (16cm) پنس جراحی کوخر



- 3006 160mm Suture Forceps پنس نخ بخیه



- 3010 115mm Iris Str قیچی ایریس سر صاف



- 3010 115mm Iris Str (TC) قیچی ایریس سر صاف دسته طلایی



Dental Surgery

جراحی دندان

Operating Scissors

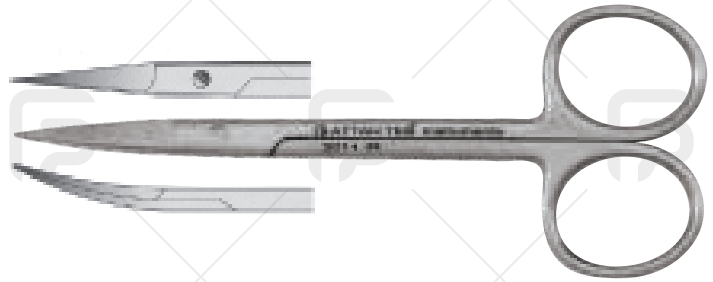

- 3011 115mm Iris Cvd قیچی ایریس سر کج

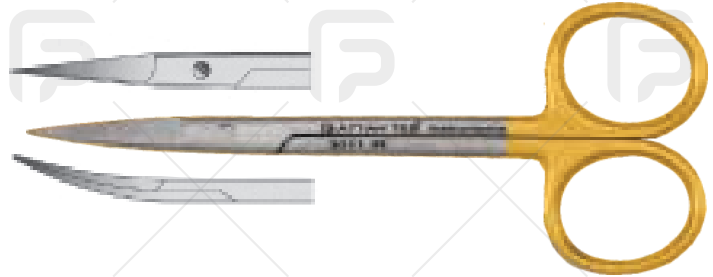

- 3011 115mm Iris Cvd (TC) قیچی ایریس سر کج دسته طلایی

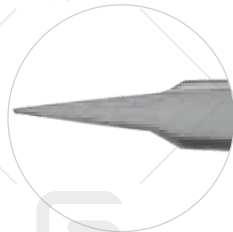

- 3012 130mm Goldman-Fox Str قیچی جراحی سر صاف گلدمن فاکس

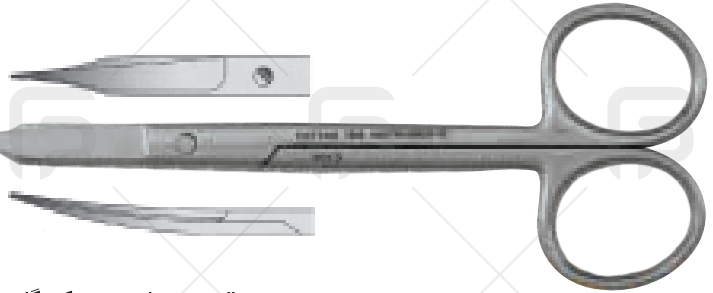

- 3013 130mm Goldman-Fox Cvd قیچی جراحی سر کج گلدمن فاکس



Dental Surgery

جراحی دندان

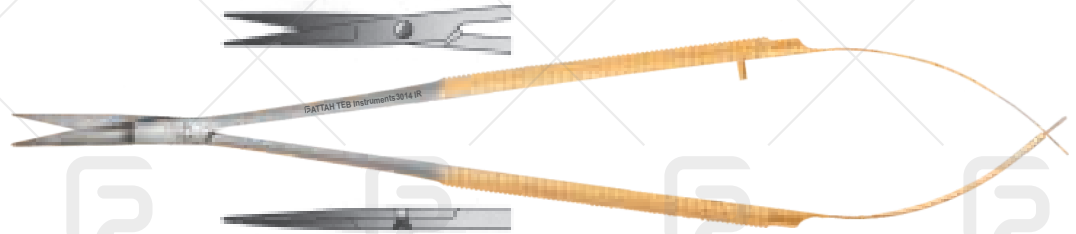

- 3014 18cm Castroviejo Scissors TC (Str) قیچی کاستروویجو (سرماف)

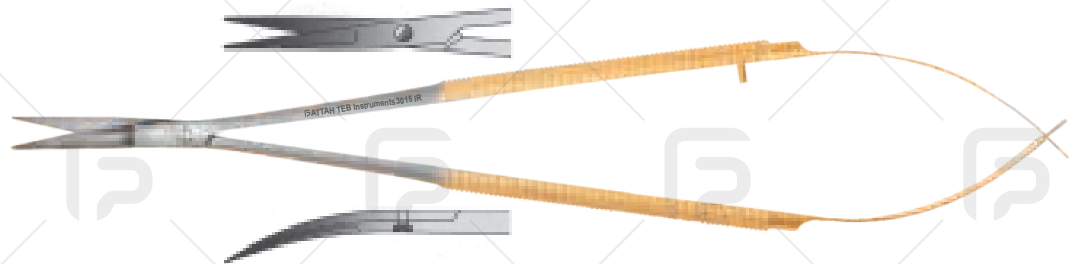

- 3015 18cm Castroviejo Scissors TC (Cvd) قیچی کاستروویجو (سر کج)



- 3016 La Grange (Carbonex) قیچی دسته خم مشکی تیتانیوم

Crown Scissors

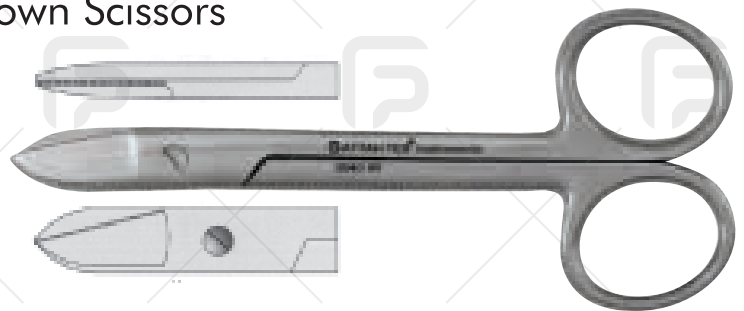

- 3040 115mm Crown Str قیچی کروان بر سر صاف

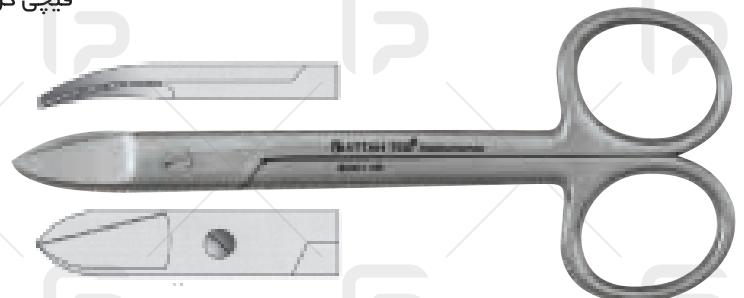

- 3041 115mm Crown Cvd قیچی کروان بر سر کج



Dental Surgery

جراحی دندان



■ 3042 16cm Kelly Str قیچی جراحی سر صاف

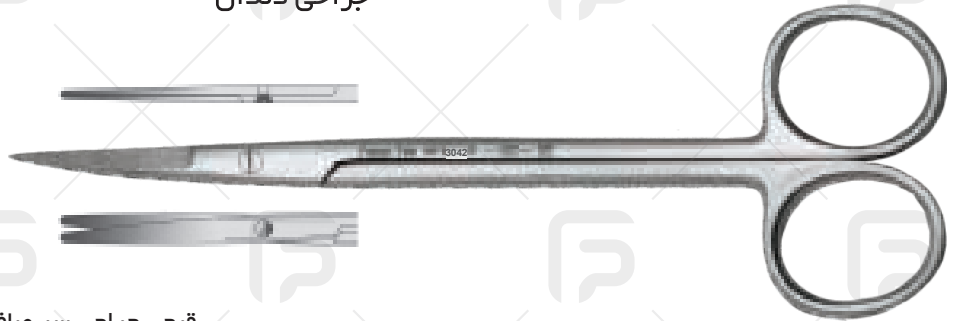

■ 3043 16cm Kelly Cvd قیچی جراحی سر کج

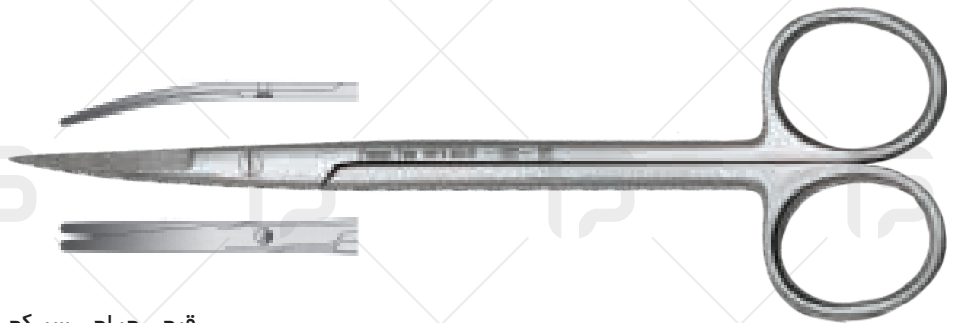

■ 3044 Iris Kelly (45 Degree) قیچی جراحی زاویه دار ۴۵ درجه

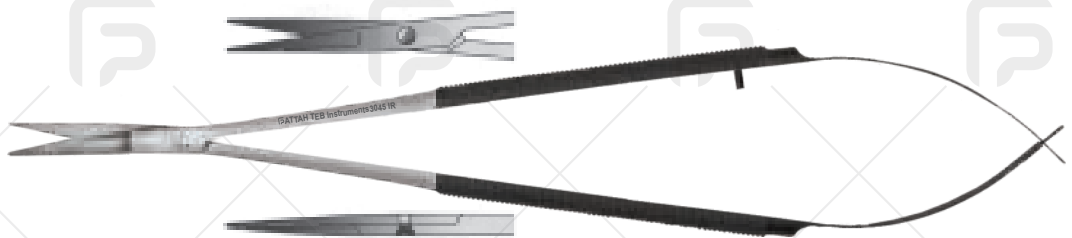

■ 3045 15cm Iris Cvd قیچی میکرو ۱۵ سانتی سر صاف

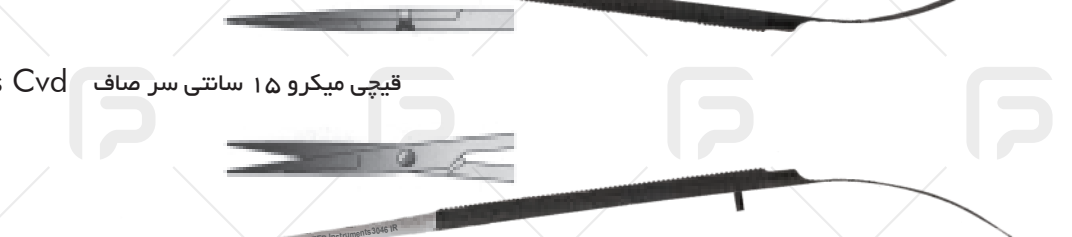

■ 3046 15cm Iris Str قیچی میکرو ۱۵ سانتی سر کج



Dental Surgery

جراحی دندان

Manual Aspirating Syringes



- 3050 1.8ml Prime Folding Syringe (سرنگ تزریق کمرشکن خاص)

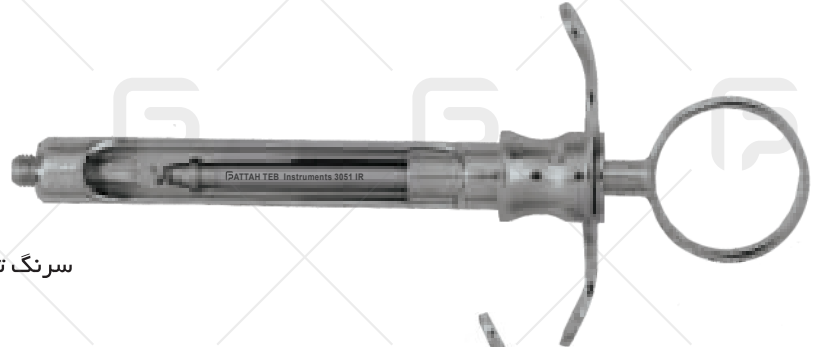

- 3051 1.8ml Fix Syringe (سرنگ تزریق ثابت)

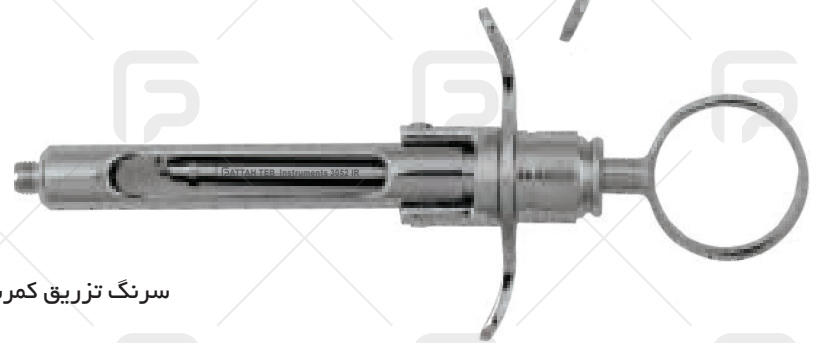

- 3052 1.8ml Folding Syringe (سرنگ تزریق کمرشکن)



- 3060 Scalpel Handle (دسته بیستوری ۳ ساده)



- 3061 Nordent Scalpel Blade Handle (دسته بیستوری ۳ مدرج)

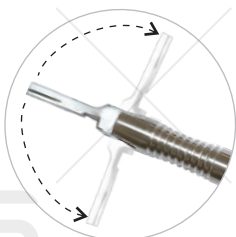

- 3062 Scalpel Handle (دسته بیستوری زاویه دار ۱۸۰ درجه)





Dental Surgery

جراحی دندان



- 3063 Scalpel Handle (Push Button) دسته بیستوری اتوماتیک گرد



- 3063B Scalpel Handle (Push Button) (Carbonex) دسته بیستوری اتوماتیک مشکی



- 3065 12mm Rongeurs Friedmann-Mini رانژور



- 3066 14mm Rongeurs Friedmann رانژور



- 3070 Periosteal Elevators الواتور پریوست



Dental Surgery

جراحی دندان



- 3072 Periosteal Elevators Buser الواتور پریوست بوزر



- 3073 Prichard Elevators الواتور پریچارد



- 3082 Suction tube (12 cm) سرساکشن فلزی

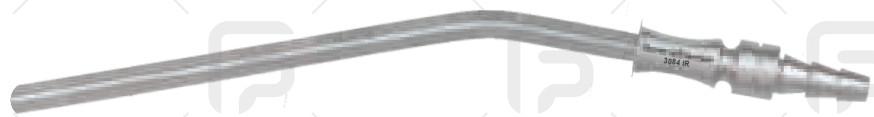

- 3084 Suction tube (14 cm) سرساکشن فلزی

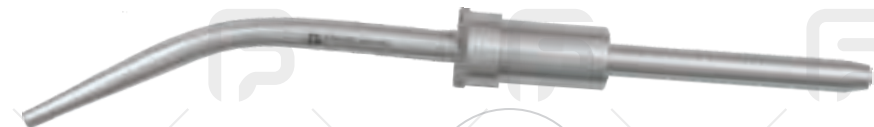

- 3086 Bone Collectores سرساکشن فیلتر دار

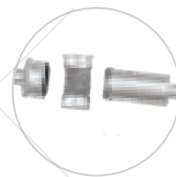



Surgery Instruments

ابزار جراحی



■ 3090 Chisels Kirkland (F.S) 13KTG چیزل 13کیتاژ فرانسوی



■ 3094 Chisels Rhodes (F.S) چیزل بک اکشن آکیتاژ فرانسوی

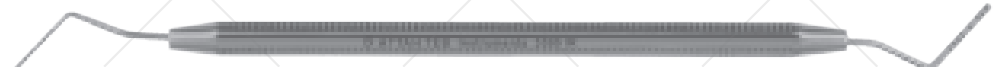

■ 3095 Williams پروب مدرج ویلیامز



■ 3095 Williams پروب مدرج ویلیامز یکسر



■ 3110 Schluger بن فایل اشلوگر ساده



■ 3110H Schluger Hollow (F.S) بن فایل اشلوگر هالو آکیتاژ فرانسوی



Surgery Instruments

ابزار جراحی



- 3111 Sugarman بن فایل شوگرمن ساده



- 3111H Sugarman Hollow (F.S) بن فایل شوگرمن هالو آلیاژ فرانسوی

Bone Files



- 3115 Miller (S) بن فایل میلر



- 3116 Miller (M) بن فایل میلر



- 3117 Miller (L) بن فایل میلر



Surgery Instruments

ابزار جراحی

کورت های قاشقی / Hemingway



■ 3120 Hemingway (S) کورت قاشقی



■ 3121 Hemingway (M) کورت قاشقی



■ 3122 Hemingway (L) کورت قاشقی



■ 3125 Orban Knife (F.S) چاقوی اوربن هالو آلیاژ فرانسوی



■ 3140 Bone Scrapers (بن اسکراپر سرصاف) (با تیغه اضافه)



■ 3141 Bone Scrapers (بن اسکراپر سرکج) (با تیغه اضافه)



Bone Thickness Gauges

بن اسکرپر

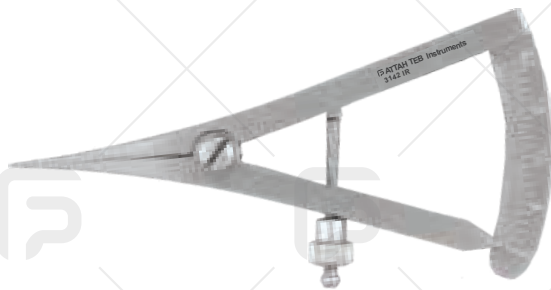

- 3142 (9cm) Castroviejo Str.
کاسترویجو کلیپر سر صاف

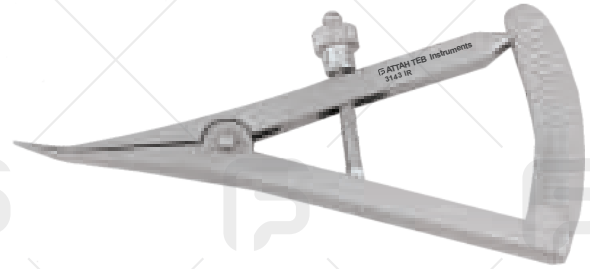

- 3143 (9cm) Castroviejo Cvd.
کاسترویجو کلیپر سر کج



- 3145 Goldman-Fox Knife چاقوی گلدمن فاکس

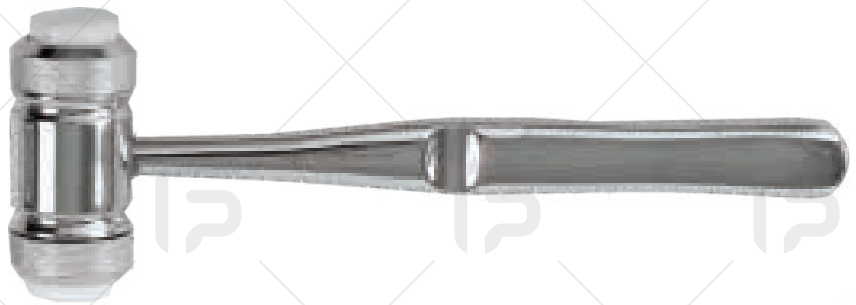

- 3150 Spare Plastic Disks, Pair (Mallet) چکش ایمپلنت ۱۴۵ گرمی

Impression - Labratuary

لابراتواری



- 2801 Plaster Spatulas (Str) همزن آلژینات / گچ سر صاف



- 2802 Plaster Spatulas (Cvd) همزن آلژینات / گچ سر کج



- 2804 Plaster Knife چاقوی گچ



Impression - Labratuary

لابراتواری

- 2810 Wax Knives Wooden Handle (S) اسپاتول موم ناودانی



- 2811 Wax Knives Wooden Handle (L) اسپاتول موم ناودانی



- 2812 Wax Knives Wooden Handle (S) چاقوی موم بدون شیار (S)



- 2813 Wax Knives Wooden Handle (L) چاقوی موم بدون شیار (L)



- 2827 Hylin وکس کارور هایلین



- 2828 Lacron اسپاتول لایکرون



- 2845 Calipers Iwanson (for metal) گیج فلز

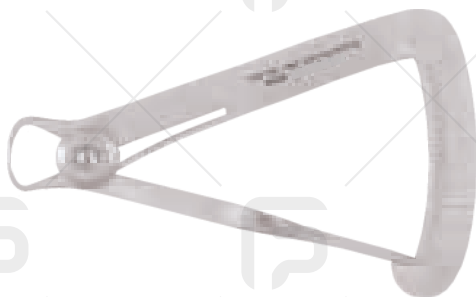

- 2846 Calipers Iwanson (for wax) گیج موم

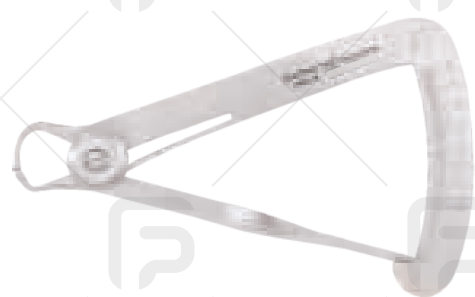

- 2847 Articulating Paper پینس کاغذ ارتیکلاسیون

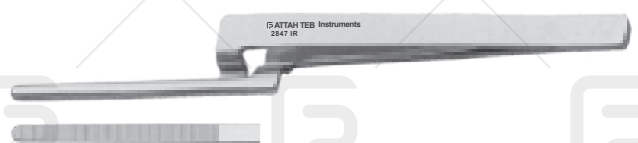



MTA Carrier

ام تی ای کریبر (لیزر کات)

- 2901 MTA (Str) ام تی ای کریبر سر صاف لیزری

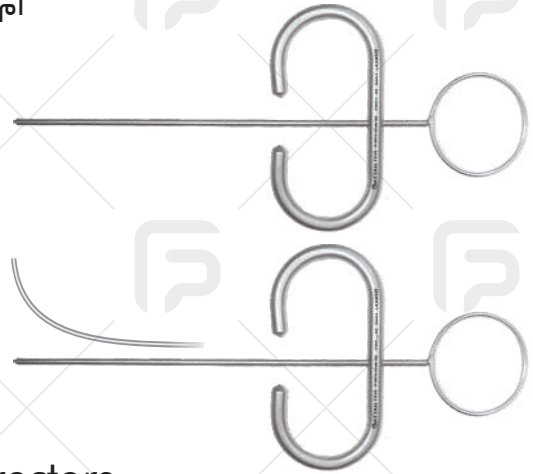

- 2902 MTA (Cvd) ام تی ای کریبر سر کج لیزری

Needle Holder, Retractors

رترکتور و سوزنگیر

- 4010 Minnesota رترکتور مینه سوتا

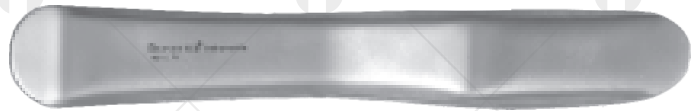

- 4011 Farabeuf رترکتور فارابوف



- 4015 Tongue Depressor رترکتور زبان گیر



- 4020 Simplex (S/E) چک رترکتور یکسر



- 4025 Simplex (D/E) چک رترکتور ۲ سر

- 4026 Mouth Gage (L) دهان باز کن مولت بزرگ





Needle Holder

سوزنگیر

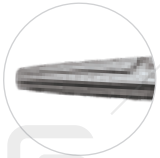

■ 4051 (12cm) Mayo-hager (Str) سوزنگیر سر صاف



■ 4052 (12cm) Mayo-hager (Cvd) سوزنگیر سر کج

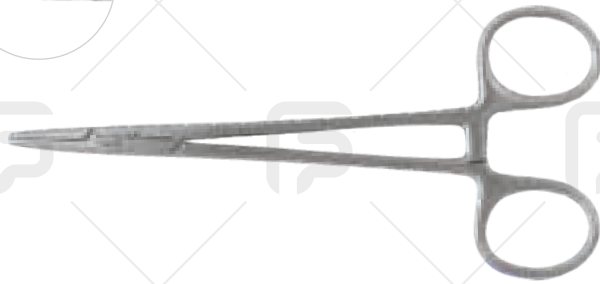

■ 4061 (14cm) Mayo-hager (Str) سوزنگیر سر صاف



■ 4062 (14cm) Mayo-hager (Cvd) سوزنگیر سر کج



■ 4064 (16cm) Mayo-hager (Str) سوزنگیر سر صاف



■ 4065 (16cm) Mayo-hager (Cvd) سوزنگیر سر کج



Haemostatic/Forceps

هموستات

Halsted Mosquito Crile

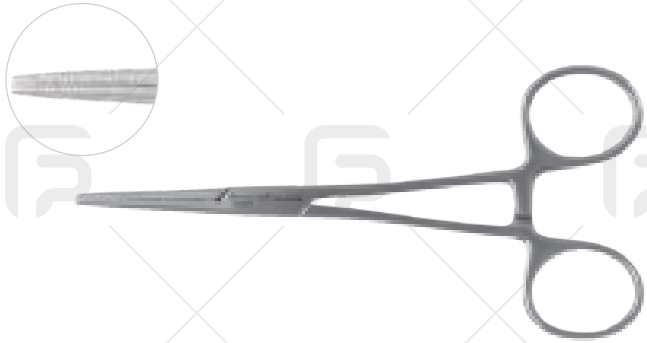

■ 4068 (12cm) Haemostatic (Str) هموستات سر صاف

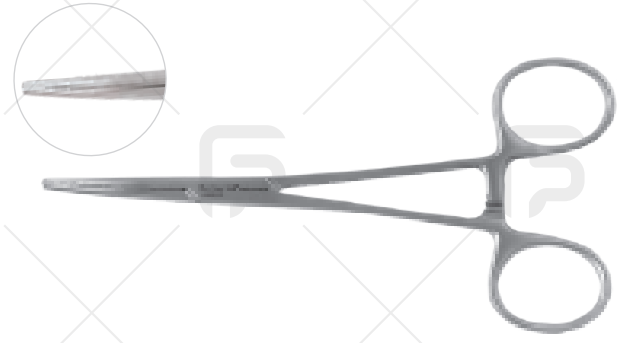

■ 4069 (12cm) Haemostatic (Cvd) هموستات سر کج

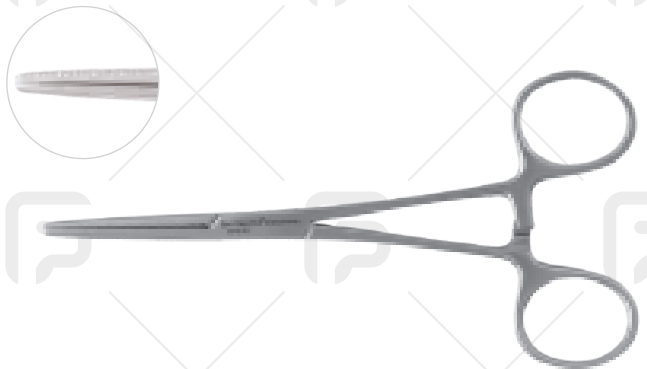

■ 4070 (14cm) Haemostatic (Str) هموستات سر صاف



■ 4071 (14cm) Haemostatic (Cvd) هموستات سر کج



■ 4075 (11cm) Mosquito (Str) موسکیتو سر صاف

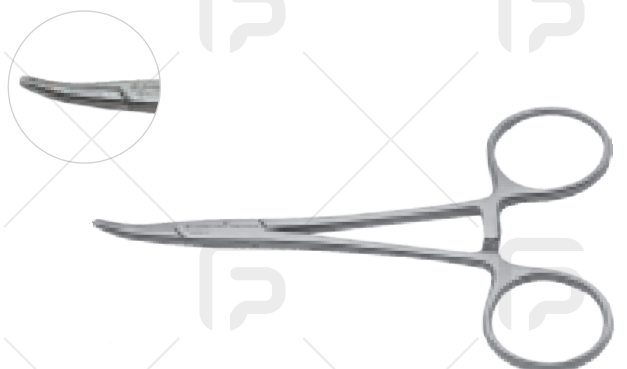

■ 4076 (11cm) Mosquito (Cvd) موسکیتو سر کج



Haemostatic/Forceps

هموستات

Halsted Mosquito Crile



■ 4078 (9cm) Mosquito موسکیتو سر صاف

■ 4079 (9cm) Mosquito موسکیتو سر کج

Towel Forceps



■ 4080 (9cm) Shain شانگیر

■ 4081 (11cm) Shain شانگیر

Splinter Forceps Stieglitz

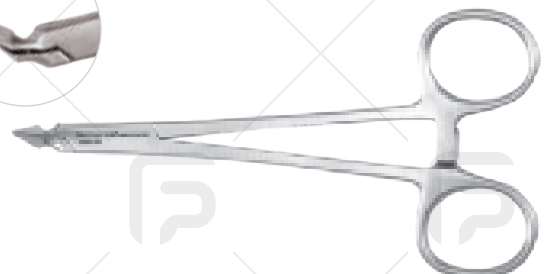
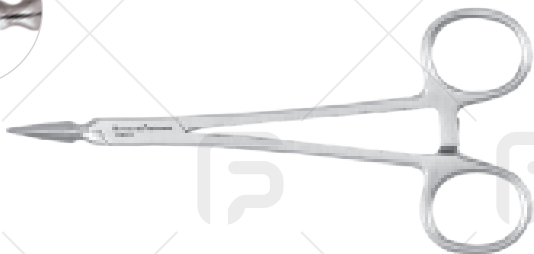

■ 4082 Needle Holder سوزنگیر سه کاره ۴۵ درجه

■ 4083 Needle Holder سوزنگیر سه کاره ۹۰ درجه



Needle Holder - Haemostatic/Forceps

هموستات و سوزنگیر

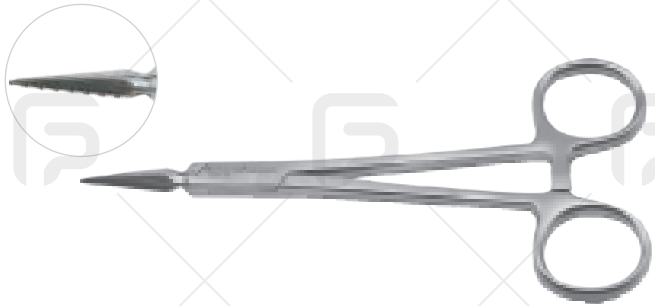

■ 4084 Needle Holder سوزنگیر سه کاره سر صاف



■ 4090 Mayo-hegar (0.5/140mm)
Needle Holder TC سوزنگیر دسته طلایی (۱۴ سانتی متر)

سوزنگیر



■ 4095 (18cm) Castroviejo Needle Holder TC سوزن گیر کاسترویچو سر صاف

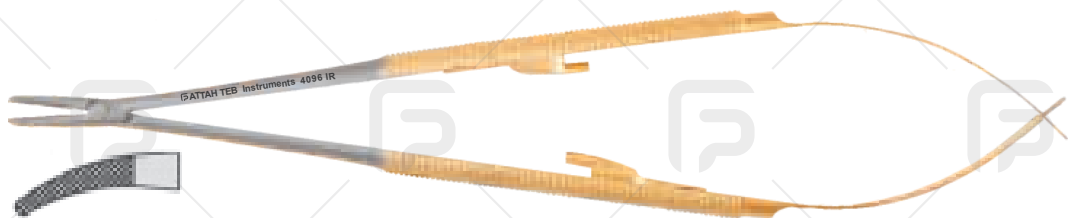

■ 4096 (18cm) Castroviejo Needle Holder TC سوزن گیر کاسترویچو سر کج



Restorative

ترمیمی

Burnishers



■ 1301 Ball Burnishers (S) برنیشر



■ 1302 Ball Burnishers (M) برنیشر



■ 1303 Ball Burnishers (L) برنیشر



■ 1313 Egg Burnishers/Burnishers برنیشر/برنیشر تخم مرغی



■ 1330 T/ Burnishers تی برنیشر



■ 1335 Egg Burnishers D/E برنیشر تخم مرغی دو سر





Restorative

ترمیمی

Pluggers

کندانسورهای آمالگام



- 1341 Condenser Plugger (S) کندانسور



- 1342 Condenser Plugger (M) کندانسور



- 1343 Condenser Plugger (L) کندانسور



- 1344 Markley Condenser Plugger (S) کندانسور مارکلی



- 1345 Markley Condenser Plugger (L) کندانسور مارکلی



Restorative

ترمیمی

Excavator



■ 1347 Excavator (S) اکسکواتر



■ 1348 Excavator (M) اکسکواتر



■ 1349 Excavator (L) اکسکواتر



Spatulae

■ 1351 Spatulae (S) اسپاتور محکمہ

■ 1352 Spatulae (M) اسپاتور محکمہ

■ 1353 Spatulae (L) اسپاتور محکمہ





Restorative

ترمیمی

Carvers

- 1360 Endometer اندومتر انگشتی لیزری

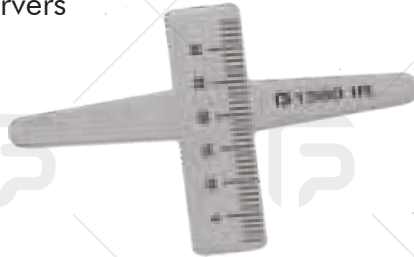

- 1361 Wards کارور نیزه ای



- 1362 Hollenback (S) کارور هولن باخ



- 1363 Hollenback (L) کارور هولن باخ



- 1364 Frahm (45 Degree) کارور لوزی ۴۵ درجه



- 1365 Frahm (90 Degree) کارور لوزی ۹۰ درجه





Restorative

ترمیمی

Filling Instruments



- 1366 Heidemann (S) اسپاتول دهانی



- 1367 Heidemann (M) اسپاتول دهانی



- 1368 Heidemann (L) اسپاتول دهانی



- 1369 Amalgam Carver (Wards) آمالگام کارور



- 1371 Tofflemire Universal ماتریس بند تافل مایر



- 1375 Cord Packers قلم نخ زیر لثه





Restorative

ترمیمی

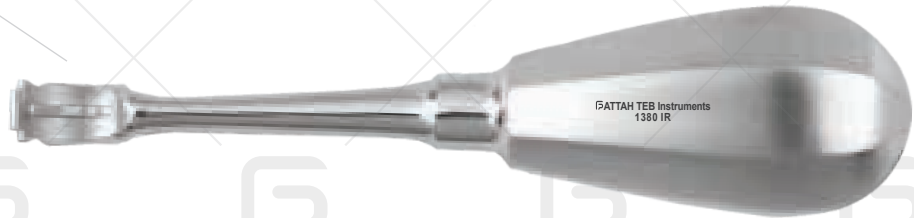

■ 1380 Crown Removers (Heavy Duty Crown Remover With large handle) کروان اسپریدر



■ 1381 Manual Crown Remover آرچ کروان ساده



■ 1385 Automatic Crown Remover آرچ کروان اتوماتیک



■ 1390 Amalgam Carrier آمالگام کریر پلاستیکی با یک سری اضافه



■ 1391 Amalgam Well گوده آمالگام



Restorative

ترمیمی

Placement Instruments



- 1397 Dycal S/E قلم دایکال یکسر



- 1398 Dycal D/E قلم دایکال دوسر

Pluggers

هند پلاگر ست ۴ عددی

- 1399-1A (Fig1) (0.5)

- 1399-1B (Fig2) (0.7)

- 1399-1C (Fig3) (0.9)

- 1399-1D (Fig4) (1.1)



Spreaders

هند اسپریدر ست ۴ عددی

■ 1399-2A



■ 1399-2B

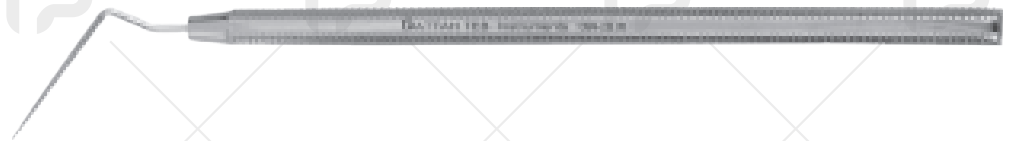

■ 1399-2C



■ 1399-2D

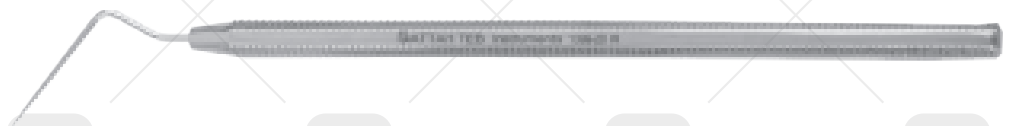

Pluggers / Heat Carriers

هیت کریئر ست ۴ عددی هالو

■ 1399-3A



■ 1399-3B

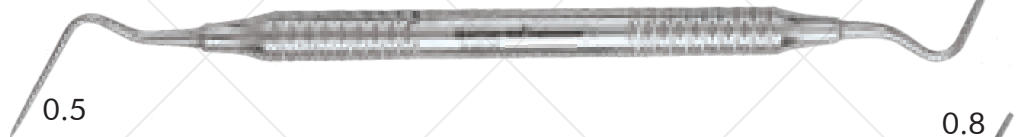

■ 1399-3C



■ 1399-3D

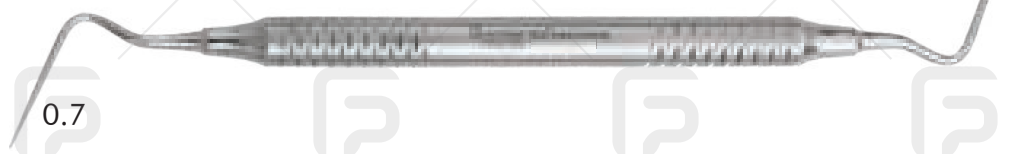



Composite Restoration Instruments (Titanium Nitride Lined)

قلم کامپوزیت روکش تیتانیوم

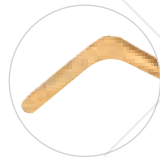

- 1501 Plastic Filling اسپاتول دهانی باریک



- 1502 Plastic Filling Rigid اسپاتول دهانی کوچک



- 1503 Plastic Filling اسپاتول دهانی پهن



- 1504 Plastic Filling Rigid اسپاتول - برنیشر



- 1505 Condenser & Heidemann Spatula Rigid کندانسور - اسپاتول دهانی متوسط

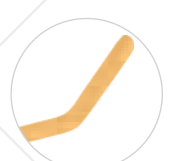







- 1506 Plastic Filling Rigid اسپاتول دهانی بزرگ

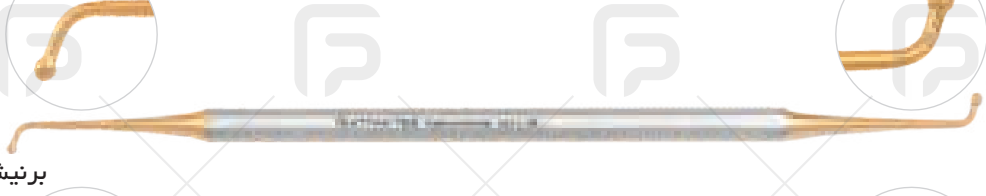

Composite Restoration Instruments
(Titanium Nitride Lined)

قلم کامپوزیت روکش تیتانیوم

- 1507 Wescott (S) برنیشر - وسکوت کوچک 
- 1508 Wescott (L) برنیشر - وسکوت بزرگ 
- 1509 Freedman Cone Shape & Condanser کندانسور مارکلی 
- 1510 Smooth Plugger کندانسور مخروطی 
- 1511 Burnisher برنیشر 
- 1512 Plugger / Heleomolar قلم کامپوزیت طرح هلیومولار 
- 1513 Condenser & Mini Spatula / Placer اسپاتول محکمه - برنیشر 





Composite Restoration Instruments (Titanium Nitride Lined)

قلم کامپوزیت روکش تیتانیوم

- 

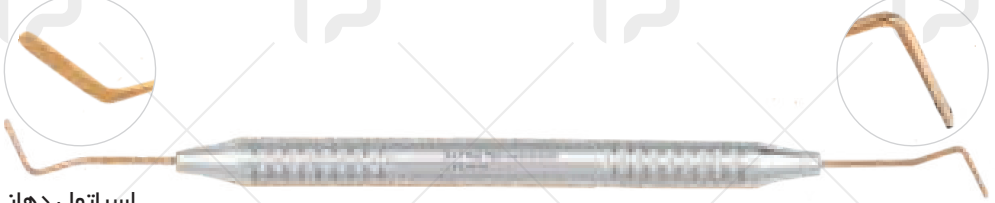
■ 1514 Flexible Curved Paddle اسپاتول دهانی خمیده هالو
- 

■ 1515 Flexible اسپاتول دهانی زاویه دار هالو
- 

■ 1516 Flexible اسپاتول دهانی هالو
- 

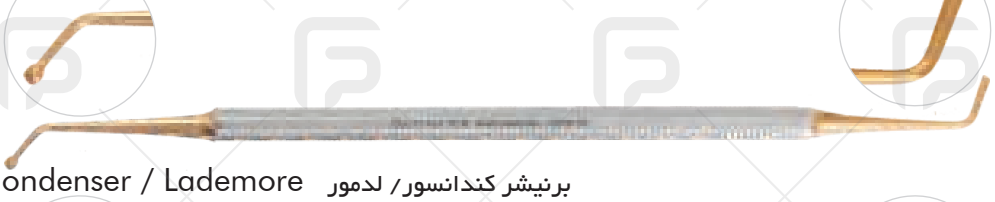
■ 1517 Heidemann & Cement Spatula (Curved) اسپاتول محکمه سرکج
- 

■ 1518 Burnisher & Condenser / Lademore برنیشر کندانسور / لدمور
- 

■ 1519 Condenser & Mini Spatula / Placer اسپاتول محکمه سرکج هالو
- 

■ 1551 OptraSculpt قلم کامپوزیت پولیش با نمد





FattahTeb
Instruments

شرکت صنایع ابزار جراحی
فتاح طب پویا

— 1881 —

Orthodontic

ارتودنسی



- 2601 Angle Round/Flat پلایر ۱۳۹



- 2610 Band Removing Pliers (TC) پلایر بند ریمور



- 2612 Johnson پلایر جانسون



- 2613 Gordon پلایر نوک مرغی



Orthodontic

ارتودنسی



- 2615 Hook Crimping Pliers پلایر کریمپیل هوک

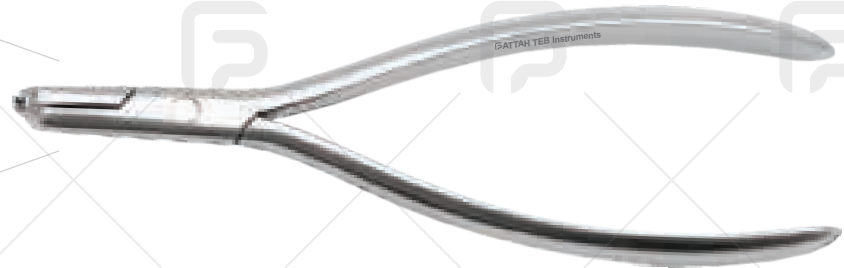

- 2620 T-Shape-Stop پلایر



- 2690 Wire Cutter TC وایر کاتر



- 2695 End Cutter TC اندکاتر



FattahTeb
Instruments

شرکت صنایع ابزار جراحی
فتاح طب پویا

— 1881 —

Orthodontic

ارتودنسی



- 2660 Elastic Ligature لیگاچر تریدر



- 2661 Ligature Director لیگاچر دایرکتور



- 2662 Elastic Remover الاستیک ریمور



- 2666 Band Seating بند سیتزر پلاستیکی



Orthodontic

ارتودنسی



- 2680 Mathieu TC سوزنگیر متیو



- 2681 Mathieu سوزنگیر متیو

Rubber dam Clamps & Forceps

رابردام



- 1700 Rubber dam Set of 13 Pcs ست رابردام ۱۳ + ۱ عددی



Rubber dam Clamps & Forceps

رابردام

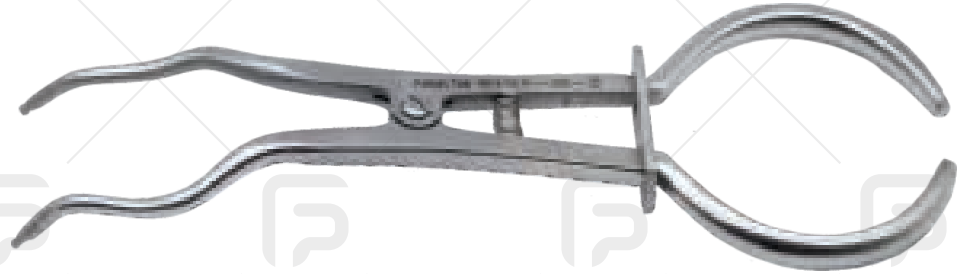

- 1751 Palmer فورسپس کلمپ یک خم



- 1753 Matrix Pliers فورسپس سکشنال ماتریس



- 1754 Ainsworth فورسپس پانچ رابردام



- 1755 Rubber dam frames (Young) فریم فلزی



Clamps Universal - B Series

کلمپ ها



■ 1763 #00

کلمپ پرمولر پایین با طوق کوچک



■ 1764 #2

کلمپ پرمولر بالا و پایین کوچک



■ 1765 #2A

کلمپ پرمولر بالا و پایین بزرگ



■ 1766 #3

کلمپ مولر بالا و پایین کوچک



■ 1767 #7

کلمپ مولر پایین



■ 1768 #8

کلمپ مولر بالا کوچک



■ 1769 #8A

کلمپ مولر های نیمه روییده و کوچک



■ 1770 #9

کلمپ یونیورسال لبیال کوچک
(پرمولر و قدامی)



■ 1771 #12

کلمپ مولر بالا - چپ و راست



■ 1772 #12A

کلمپ مولر بالا - چپ و راست



■ 1773 #14

کلمپ مولر بالا و پایین بزرگ

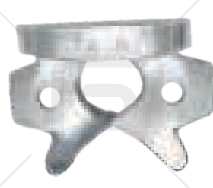

■ 1774 #14A

کلمپ مولر های نیمه روییده و بزرگ



■ 1775 #200

کلمپ ۲۰۰



■ 1776 #201

کلمپ مولر پایین با باله



■ 1777 #205

کلمپ شماره ۲۰۵



■ 1778 #206

کلمپ پرمولر بالا و پایین با باله



■ 1779 #207

کلمپ ۲۰۷



■ 1780 #209

کلمپ پرمولر پایین کوچک



■ 1781 #210

کلمپ لبیال سانترال



■ 1782 #211

کلمپ یونیورسال لبیال



■ 1783 #212

کلمپ لبیال قدامی



■ 1784 #B1

دندان های مولر پایین



■ 1785 #B2

دندان های آسیاب کوچک



■ 1786 #B3

دندان های آسیاب راست



■ 1787 #B4

قدامی و نیش



■ 1788 #B5

ترمیمهای کلاس ۵



■ 1789 #B6

ترمیمهای کلاس ۵



Gracey Curettes (F.S)

جرمگیری (آبیاژ فرانسوی)

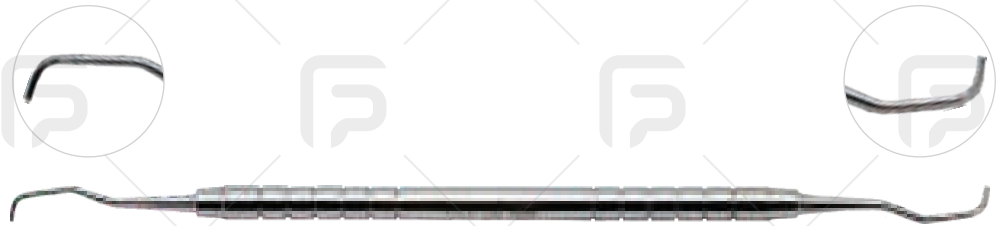

- 1/2 Anterior teeth گریسی



- 3/4 Anterior teeth گریسی



- 5/6 Anterior and Premolars گریسی



- 7/8 Premolars and Molars گریسی



Gracey Curettes (F.S)

جرمگیری (آلیاژ فرانسوی)



- 9/10 Molars Buccal and Lingual Surfaces گریسی



- 11/12 Posterior Mesial Surfaces گریسی

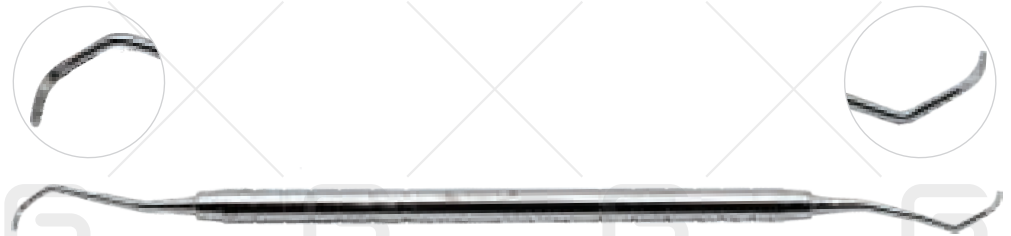

- 13/14 Posterior Distal Surfaces اسکیلر مکال



- 13/14 S Universal Macall اسکیلر مکال



Gracey Curettes (F.S)

جرمگیری (آلیاژ فرانسوی)



- 15/16 Posterior Mesial Surfaces اسکیلر مکال



- 17/18 Posterior Distal Surfaces اسکیلر مکال



- U 15/30 Sickles Scaler اسکیلر مکال



- U 15/33 Sickles Scaler اسکیلر مکال



Sterilization

ظروف استیل



■ 2501 X-Ray Clip

گیره فیلم تکی



■ 2511 Cotton Dispensers Stainless Steel
جای پنبه فنردار گرد



■ 2515 Cotton Container Stainless Steel (S)
جای پنبه درب دار



■ 2516 Cotton Container Stainless Steel (M)
جای پنبه درب دار



■ 2521 Kidney Trays S رسیور قلوه ای

■ 2522 Kidney Trays M رسیور قلوه ای

■ 2523 Kidney Trays L رسیور قلوه ای



■ 2528 Adjustable Spirit Lamp
چراغ الکی قابل تنظیم



■ 2533 Forceps Jars چیتل

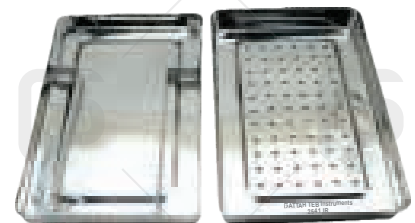

■ 2541 Flat Tray with holes (One side)
سینی درب دار یک طرف سوراخ دار



Sterilization

ظروف استیل

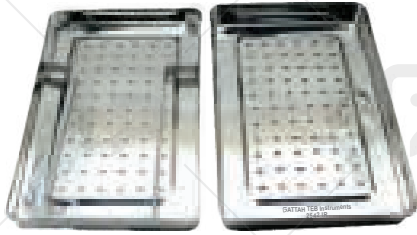

- 2542 Flat Tray with holes (Both side)

سینی درب دار دو طرف سوراخ دار



- 2551 Instruments Trays (S) سینی معاینه

- 2552 Instruments Trays (M) سینی معاینه

- 2553 Instruments Trays (L) سینی معاینه



- 2554 Tray With Lid (S) دیش درب دار

- 2556 Tray With Lid (L) دیش درب دار



- 2558 Tray Cassettes for 10 Instruments

جعبه ابزار درب دار سیلیکونی ۱۰ عددی



- 2563 Galipots گالی پات ۶۰

- 2564 Galipots گالی پات ۹۰

- 2565 Galipots گالی پات ۱۲۰



- 2582 Drums (S) بیكس گاز

- 2583 Drums (M) بیكس گاز



دفتر مرکزی : تهران ، خیابان کارگر جنوبی
برج مهستان ، طبقه ۹ ، واحد ۹۰۴

تلفن : ۰۲۱ - ۶۶۵ ۶۶۸ ۷۴

فکس : ۰۲۱ - ۶۶۵ ۶۶۸ ۷۵

واتس اپ : ۰۹۱۲ - ۰۸۹ ۵۱ ۶۵

ایمیل : info@Fattahteb.com

سایت : www.Fattahteb.com

فروشگاه : تهران ، خیابان آزادی ،

ساختمان سینا سنتر ، واحد ۳

تلفن : ۰۲۱ - ۶۵۸ ۷۰۱ ۷۷