

RVG 142, RVG 5200 and RVG 6200

User &
Installation Guide

Contents

Notice	4
Conventions in this Guide	5
RVG 142, RVG 5200 and RVG 6200 Overview	6
RVG 142, RVG 5200 and RVG 6200 Overview	6
Sharing the RVG Sensor Between Workstations	7
Imaging Software Overview	8
Imaging Software Overview	8
Control Panels of RVG Sensors in CS Imaging	9
Full Mouth Series (FMS) Image Acquisition Overview	10
Setting Up RVG 142, RVG 5200 and RVG 6200	13
Setting Up RVG 142, RVG 5200 and RVG 6200	13
Post Installation Procedure (Optional)	16
Acquiring Single Images Using RVG 142, RVG 5200 and RVG 6200	17
Preparing the Acquisition of a Single Image Using RVG 142, RVG 5200 & RVG 6200	17
Single Image X-ray Exposure Times	19
Acquiring Single Image Using RVG 142, RVG 5200 & RVG 6200	20
Acquiring FMS Images Using RVG 142, RVG 5200 and RVG 6200	21
Preparing Acquisition of FMS Images Using RVG 142, RVG 5200 & RVG 6200	21
FMS Images X-ray Exposure Times	23
Acquiring FMS Images Using RVG 142, RVG 5200 & RVG 6200	24
Retaking FMS Images with RVG 142, RVG 5200 and RVG 6200	26
Setting Up and Using RVG Connect for RVG 6200	28
Setting Up and Using RVG Connect for RVG 6200	28
RVG Connect Unit Overview	30
RVG Connect Menu	32
Imaging Software Overview	33
Setting Up RVG Connect	34
Installing RVG Connect Hardware	37
Network Configuration	39
Checking Dynamic Attribution of IP Address	40
Activating DHCP Configuration	41
Assigning Default Static IP Address with Automatic Device Detection	42
Manually Assigning Static IP Address	43
Assigning IP Address to RVG Connect Unit Using RVG Service Tools with Bonjour	44
Assigning IP Addresses to RVG Connect Unit Using RVG Service Tools without Bonjour	45
Managing List of IP Addresses for Use on Several Workstations	46
Pairing RVG Connect Units with a Workstation	47
Associating Buttons on RVG Connect Unit with Workstation (Optional)	49
Initializing the RVG Sensor with RVG Connect for First Time	50
Preparing Acquisition of Single Image Using RVG Connect	51
Single Image X-ray Exposure Times	53
Acquiring Single Image Using RVG Connect	54
Preparing Acquisition of FMS Images Using RVG Connect	56
FMS Images X-ray Exposure Times	58
Acquiring FMS Images Using RVG Connect	59
Retaking FMS Images with RVG 142, RVG 5200 and RVG 6200	61

Troubleshooting	63
Contact Information	64

Notice

The User & Installation Guide for RVG 142, RVG 5200 and RVG 6200 includes information on the device as well as its installation and usage. We recommend that you familiarize yourself with this guide to make the most effective use of your system.

RVG 142, RVG 5200 and RVG 6200 are intended to produce images of the dento-maxillofacial region of the human anatomy at the direction of health care professionals.



IMPORTANT: We recommend that you consult the *RVG 142, RVG 5200 and RVG 6200 Safety, Regulatory and the Technical Specification User Guide (SM847)* before using RVG 142, RVG 5200 and RVG 6200.

The information contained in this guide may be subject to modification without notice, justification or notification to the persons concerned.

No part of this guide may be reproduced without the express permission of Carestream Dental LLC.

The U.S. Federal law restricts this device to sale by or on the order of a physician.

This document is originally written in English.

Manual Name: RVG 142, RVG 5200 and RVG 6200 User & Installation Guide

Document Code: SM846

Revision Number: 07

Print Date: 2021-10

The brand names and logos reproduced in this guide are copyright.

Bonjour is a trademark of Apple Inc., registered in the U.S. and other countries.

RVG 142, RVG 5200 and RVG 6200 comply with Medical Device Directive 93/42/EEC until September 14, 2022. After this date, the products will be certified according to Medical Device Regulation (EU) 2017/745 and Medical Devices Regulations 2002 (SI618) as subsequently amended by the EU Exit Regulations of 2019 (SI 791) and 2020 (SI 1478), Class IIa.



Conventions in this Guide

The following special messages emphasize information or indicate potential risk to persons or equipment:



WARNING: Warns you to avoid injury to yourself or others by following the safety instructions precisely.



CAUTION: Alerts you to a condition that might cause serious damage.



IMPORTANT: Alerts you to a condition that might cause problems.



Note: Emphasizes important information.



Tip: Provides extra information and hints.

RVG 142, RVG 5200 and RVG 6200 Overview

Functional Components Overview

Types of RVG Sensor

The RVG sensor is radio-sensitive. The active surface of the RVG sensor is the flat surface marked with #1 or #2 indicating the size of the sensor. (For RVG 142, only one sensor size is available.)

The following table summarizes RVG sensor type, size and typical usage:

Type	Size	Use
RVG 142		
RVG 5200	Size 1 (universal RVG sensor)	Regular periapical and retro-coronary procedures.
RVG 6200		
RVG 142		
RVG 5200	Size 2	Bitewings and periapical procedures.
RVG 6200		

The non-reactive surface of the RVG sensor is rounded and contains the cable attachment.

RVG Sensor Overview

Figure 1 RVG Sensor

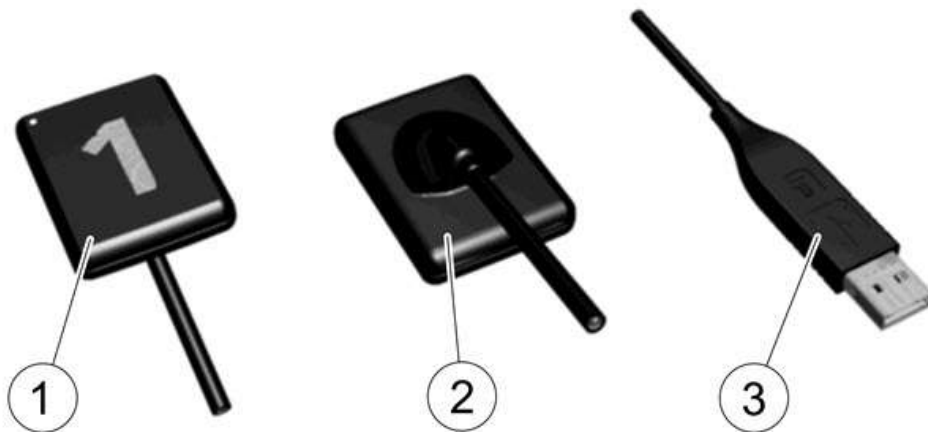

1 Active surface of the RVG sensor.

2 Non-reactive surface of the RVG sensor.

3 USB 2.0 connector.

Note: For RVG Connect, there is a specific RVG 6200 sensor with a magnetic USB 2.0 connector (see [Setting Up and Using RVG Connect for RVG 6200](#)).

Sharing the RVG Sensor Between Workstations

Single RVG Sensor/Multiple Workstations

You can share the RVG sensor between several workstations to provide access for several practitioners based on an agreed-upon arrangement.

Each workstation must have CS Imaging Software and corresponding drivers installed.

To share the RVG sensor between several workstations, move it from workstation to workstation. The RVG sensor is automatically recognized and operational when you connect it to a USB 2.0 port that is connected directly to the motherboard (generally located on the back of the workstation).



IMPORTANT: To ensure the best quality images, you must connect the RVG sensor to a USB 2.0 port that is connected directly to the motherboard (generally located on the BACK of the workstation).

Sharing Images Between Workstations

To share images between workstations, you can connect the workstations to a network without having to change the configuration described above.

CS Imaging Software only needs to access a shared database on the same workstation or on a remote workstation.

You can print images either on a printer attached to each workstation or to a printer shared on the network.

Using the Different Positioning Systems

Apply the same rules for positioning the RVG sensor in the mouth that you use in classic radiology. You can use different systems for positioning the RVG sensor in the mouth.

A starter kit is provided with each RVG sensor (except RVG 142 - positioners can be purchased separately).

X-ray Source Compatibility

The RVG sensor is compatible with all X-ray sources that meet the current standards of intraoral radiology. We recommend a high-frequency X-ray source. The X-ray source must operate with a voltage of 60 to 70 kV. X-ray sources from Carestream meet the requirements.



IMPORTANT: The RVG sensor is NOT compatible with X-ray sources that have a voltage LESS THAN 60 kV.

Imaging Software Overview

Computer System Requirements

Minimum computer system requirements for RVG 142, RVG 5200 and RVG 6200 are given in the **RVG 142, RVG 5200 and RVG 6200 Safety, Regulatory and Technical Specifications User Guide (SM847)**. If necessary you must update your computer system configuration.

General Software Overview

RVG 142, RVG 5200 and RVG 6200, and RVG Connect operate with CS Imaging Software. You can acquire:

- Single images
- Full mouth series (FMS)

Single Image Acquisition Overview

You can acquire individual images using CS Imaging Software.

Figure 2 CS Imaging Software with One Active RVG Sensor Connected





CS Imaging Software can display up to three RVG sensors connected to the workstation. The color of the RVG icon shows connection status:

Icon	Explanation
	Displays the RVG Sensor list so that you can pair the RVG Connect sensor plugged into the RVG Connect unit with this workstation. See Pairing RVG Connect Units with a Workstation .
	RVG Connect unit or RVG sensor are connected to the workstation and are ready for image acquisition.
	Displayed when the RVG Sensor list is open and indicates that the RVG Connect unit is connected to the workstation but is not ready for image acquisition. See Pairing RVG Connect Units with a Workstation .
	RVG sensor is connected to the workstation but an error has occurred. An error message will be displayed in a popup window.

Control Panels of RVG Sensors in CS Imaging

RVG sensors have Control Panels with different options to carry out intraoral exams.

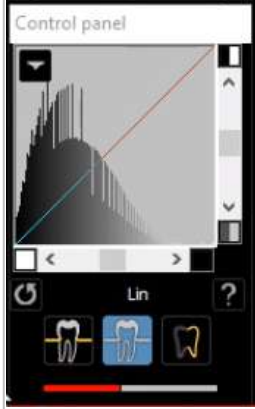
RVG 6200	RVG 5200	RVG 142
Options		
 <p>The screenshot shows the RVG 6200 control panel. It features a histogram at the top with a red diagonal line. Below the histogram are navigation arrows and a 'Lin' label. The main menu includes icons for Contrast/Brightness, Optiview, Video reverse, Pseudo color 1, Pseudo color 2, CS Adapt full version, and Dose indicator. A 'Adapt-Anatomic Endo 1' filter is selected, indicated by a star icon.</p>	 <p>The screenshot shows the RVG 5200 control panel. It features a histogram at the top with a red diagonal line. Below the histogram are navigation arrows and a 'Lin' label. The main menu includes icons for Contrast/Brightness, Optiview, Video reverse, Pseudo color 1, Pseudo color 2, and Perio/Endo/DEJ + 6 filter levels. A filter is selected, indicated by a star icon.</p>	 <p>The screenshot shows the RVG 142 control panel. It features a histogram at the top with a red diagonal line. Below the histogram are navigation arrows and a 'Lin' label. The main menu includes icons for Contrast/Brightness, Optiview, Video reverse, Pseudo color 1, Pseudo color 2, and Perio/Endo + one filter level. A filter is selected, indicated by a star icon.</p>
<p>Histogram Contrast/Brightness Optiview Video reverse Pseudo color 1 Pseudo color 2 CS Adapt full version Dose indicator</p>	<p>Histogram Contrast/Brightness Optiview Video reverse Pseudo color 1 Pseudo color 2 Perio/Endo/ DEJ + 6 filter levels Dose indicator</p>	<p>Histogram Contrast/Brightness Perio/Endo + one filter level Dose indicator</p>

Full Mouth Series (FMS) Image Acquisition Overview

Click  in the Imaging Window to access the RVG FMS Acquisition interface.

The Full Mouth Series (FMS) is a static representation of the mouth of the patient using a series of intraoral images. The images are placed in fixed numbered frames.

Figure 3 RVG FMS Acquisition Interface Home Page

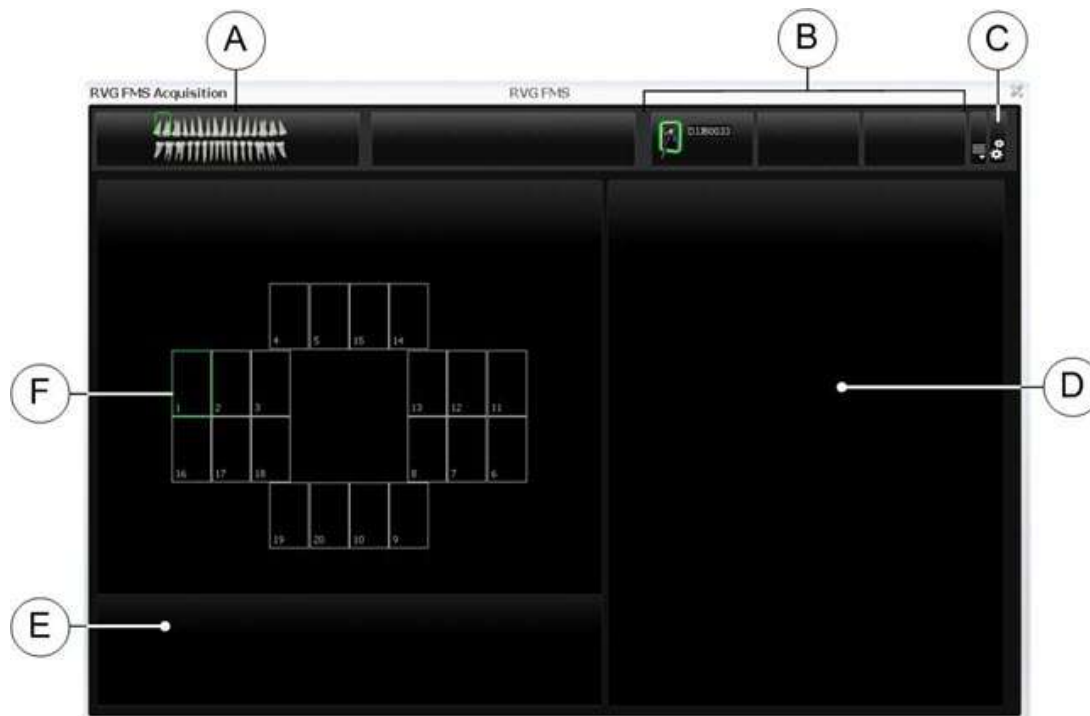

-
- A Dental arch: Highlights the acquisition zone.
 - B Available RVG sensors: Displays a maximum of three RVG sensors with their name.
 - Green: RVG sensor is connected to the workstation and is ready for image acquisition.
 - Blue: RVG sensor is connected to the workstation but is not ready for image acquisition.
 - C Preferences: Displays preferences for FMS template selection (see FMS Preferences below).
 - D Preview screen: Displays the current acquired image.
 - E Retake Image gallery: Displays all the retake images acquired for a specific frame.
 - F FMS template: Displays frame templates for acquisition.
 - Green highlight: Frame ready for new acquisition
 - Blue highlight: Frame in the revue and retake mode. This mode interrupts the automatic acquisition sequence. The retake images are displayed in the Retake Image gallery.
-

Figure 4 FMS Preferences

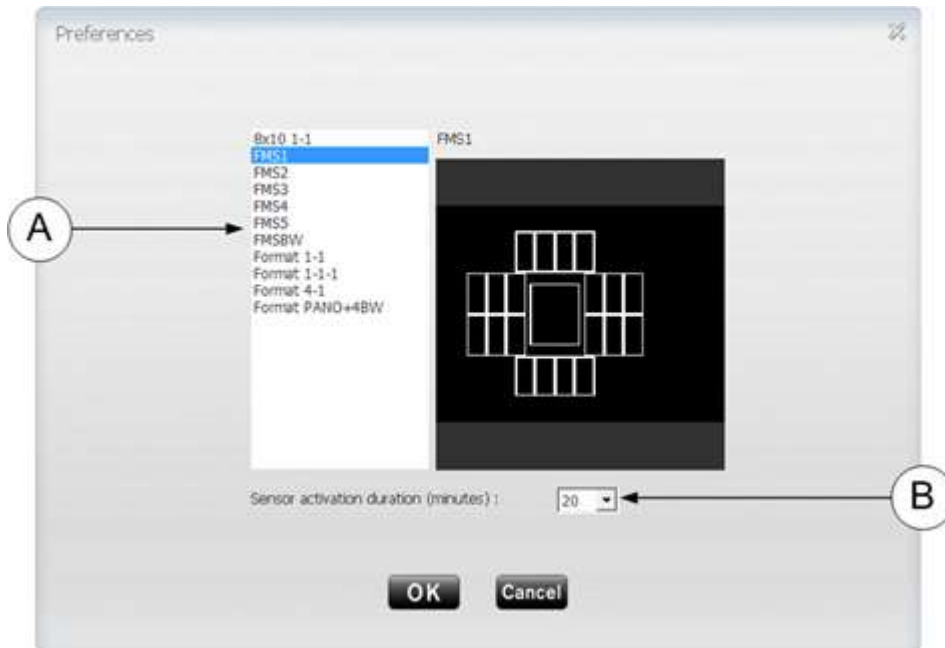

Preferences enable you to select:

-
- | | |
|--------------------------------|--|
| List of FMS templates (A) | List of available FMS templates for acquisition. You can modify existing templates and create new templates (see the <i>CS Imaging Software Online Help</i>). |
| Sensor activation duration (B) | Amount of time (in minutes) the sensor will be active.
N/A for RVG 142, RVG 5200 and RVG 6200. |
-

You can select your preferences before starting to acquire images.

If you try to change the FMS template after you have finished your image acquisitions you are prompted with a warning that indicates that you risk losing some of the images.

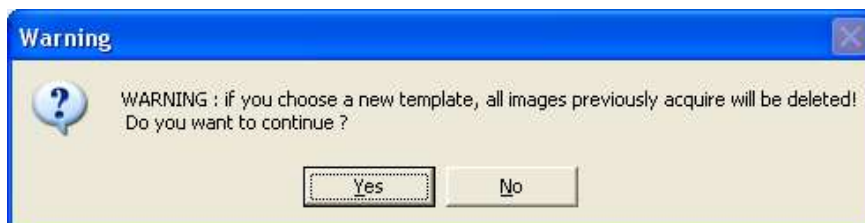
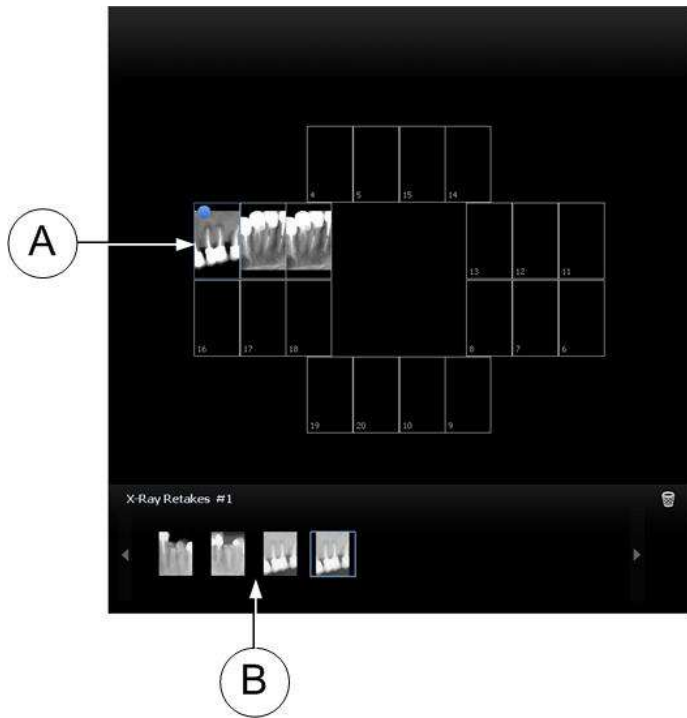

Figure 5 FMS Retake Image Gallery



A blue circle in the corner of the FMS frame (A) indicates that there are retake images for this specific frame. The images are automatically saved unless you want to select and delete them.

The FMS retake image gallery (B) only displays the images acquired for the frame highlighted in blue in the FMS template (A).

Setting Up RVG 142, RVG 5200 and RVG 6200



IMPORTANT: The specific end of support for Windows 7 was January 14, 2020. Microsoft strongly recommends that you move to Windows 10 to avoid a situation where you need service or support that is no longer available. The drivers that are mentioned in this guide are Windows 10 compatible. If you are using Windows 7, contact your dealer for the required information.

1. Insert the CS Imaging Software DVD-ROM (1/2) in the DVD-ROM drive and install the software (see the CS Imaging Software documentation).
2. Insert the Drivers DVD-ROM (2/2) in the DVD-ROM drive.

The Installer Language dialog box is displayed:



3. Select the installer language and click OK.

The Welcome to the RVGDriver Setup Wizard dialog box is displayed:

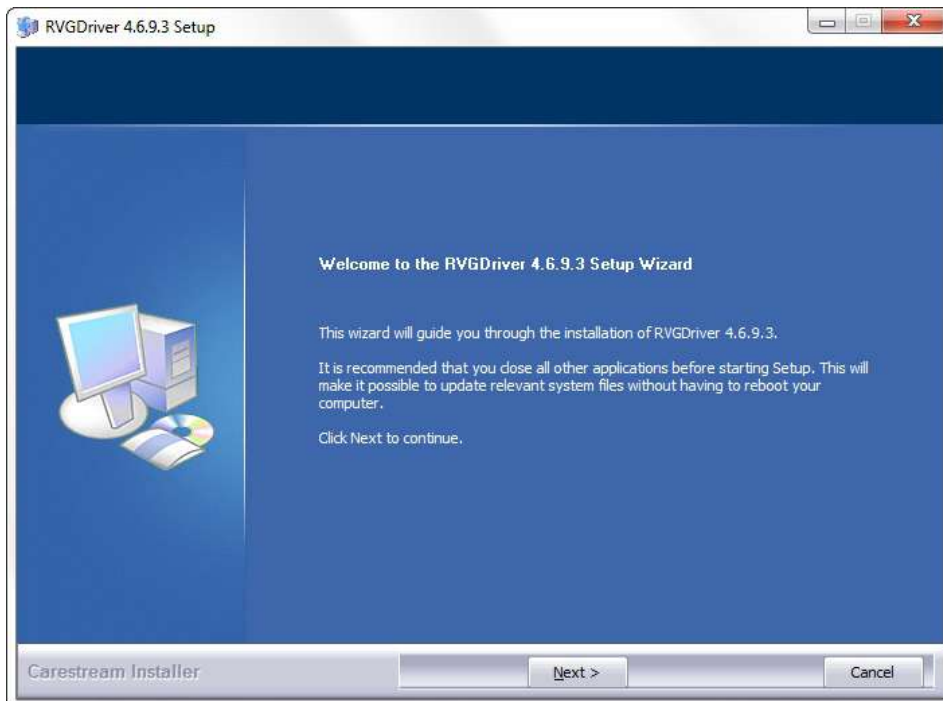

4. Click Next.

The Choose Components dialog box is displayed.



IMPORTANT: Do NOT uncheck any boxes that are already checked.

5. Select RVG 142/5200/6200 and click Install.

The Installing dialog box is displayed:

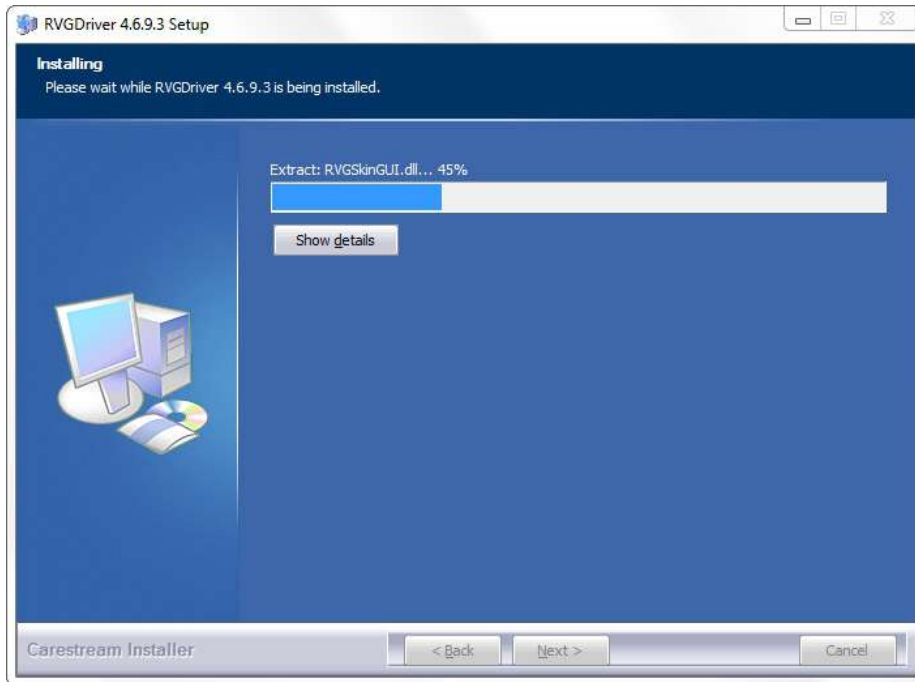

Note: If your workstation is running Microsoft Windows XP, a warning is displayed and you need to click Continue Anyway.

6. Click Next.

When the installation is complete, the Completing the RVGDriver Setup Wizard dialog box is displayed:

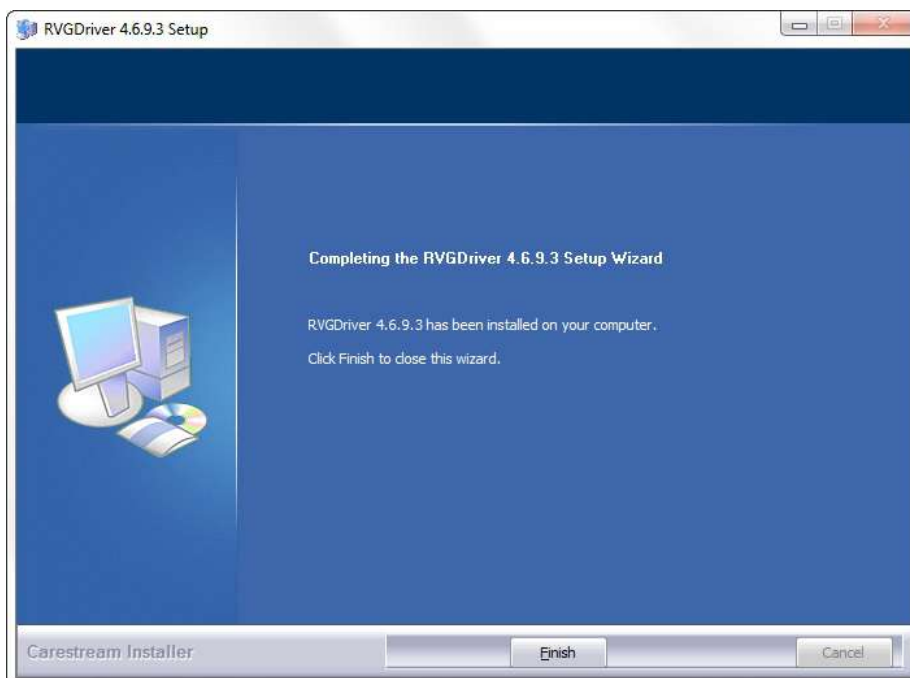

7. Click Finish.

Then restart your computer (recommended but not mandatory).

8. Connect the RVG sensor to a USB 2.0 port that is connected directly to the motherboard (generally located on the back of the workstation).

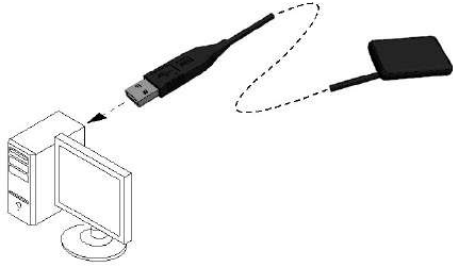

IMPORTANT: To ensure the best quality images, you must connect the RVG sensor to a USB 2.0 port that is connected directly to the motherboard (generally located on the BACK of the workstation).

The Found New Hardware Wizard is displayed.



9. Click Install the software automatically (Recommended), then click Next.
10. Verify the RVG sensor by running the post installation procedure.

Post Installation Procedure (Optional)

These steps are optional after you have installed the CS Imaging Software:

1. Click  on your desktop to start the RVG 142/5200/6200 Service Tools.

The Service Tools home page is displayed.

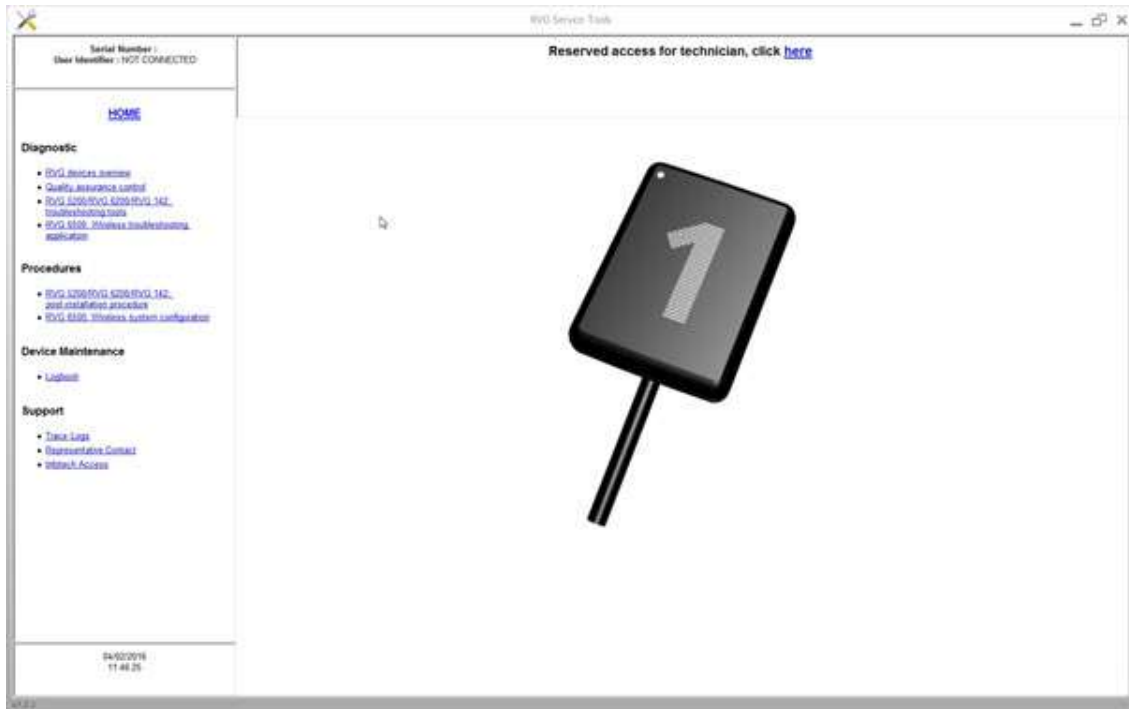

2. Click Post Installation Procedure then follow the instructions on screen.
3. Activate the relevant license key when prompted.

Preparing the Acquisition of a Single Image Using RVG 142, RVG 5200 & RVG 6200

To prepare the acquisition of a single image using RVG 142, RVG 5200 and RVG 6200, follow these steps:

1. Select the appropriate size of RVG sensor (see Types of RVG Sensor).
2. Connect the RVG sensor to a USB 2.0 port that is connected directly to the motherboard (generally located on the back of the workstation).

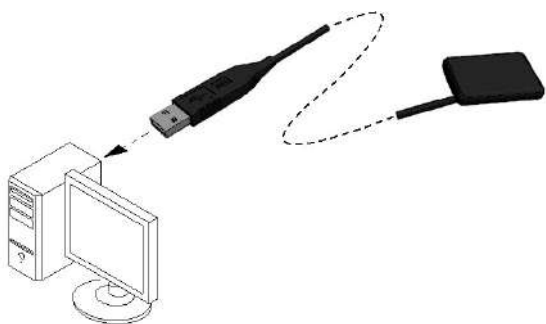

IMPORTANT: To ensure the best quality images, you must connect the RVG sensor to a USB 2.0 port that is connected directly to the motherboard (generally located on the back of the workstation).

3. Access the Imaging Window from the patient file.

The  icon is displayed in the Imaging Window toolbar indicating that an RVG sensor is connected to the workstation and is ready for acquisition (see Single Image Acquisition Overview).



4. Select an appropriate positioner for the region of interest and the size of the sensor.
5. Cover the RVG sensor with a disposable hygienic sleeve specifically designed for each size of RVG sensor.

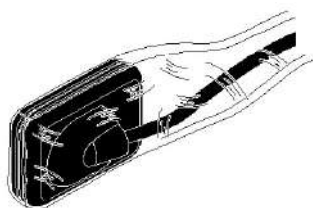

IMPORTANT: Use a NEW hygienic sleeve for each new patient to prevent cross-contamination.

6. Place the protected RVG sensor in the biteblock of the RVG sensor positioner.

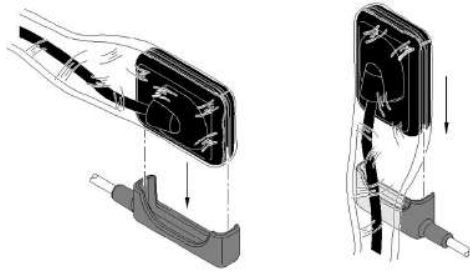

7. Position the RVG sensor in the mouth of the patient depending on the region of interest.

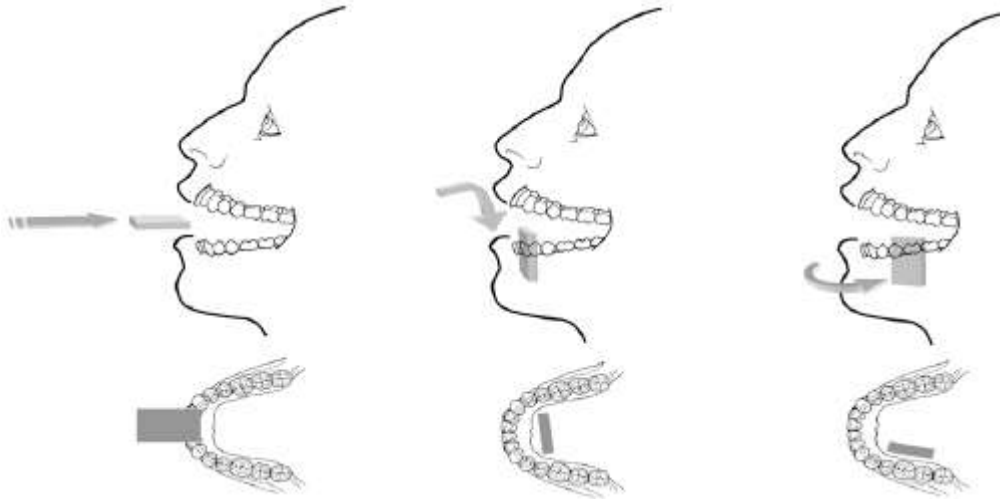

IMPORTANT: Always insert the RVG sensor holding it horizontally for the comfort of the patient.

8. Move the X-ray source tube head close to the patient and align it with the tooth of the patient and the RVG sensor.



IMPORTANT: Make sure that the tube head is not shaking.

9. Select the X-ray exposure time according to the region of interest and the patient type.

Single Image X-ray Exposure Times

Follow the user instructions of your X-ray source. The following tables provide guidelines for exposure times for an X-ray source at 70 kV and 7 mA. Add your values for the exposure time in seconds in the column on the right. If your time values are different from the suggested time values, adapt your time values until you find the best setting for your diagnostic.

Table 1 ADULT exposure times

Acquisition Mode	Suggested Exposure Time in Seconds	Your Exposure Time in Seconds
Upper incisor/canine	0.18	
Upper premolar	0.24	
Upper molar	Up to 0.40	
Lower incisor/canine	0.12	
Lower premolar	0.18	
Lower molar	0.24	

Table 2 CHILD exposure times

Acquisition Mode	Suggested Exposure Time in Seconds	Your Exposure Time in Seconds
Upper incisor/canine	0.11	
Upper premolar	0.15	
Upper molar	0.24	
Lower incisor/canine	0.075	
Lower premolar	0.11	
Lower molar	0.15	



IMPORTANT: These are suggested exposure times and need to be adjusted for your specific X-ray source. For dark images, reduce the exposure time and for grainy images, increase the exposure time.

Acquiring Single Image Using RVG 142, RVG 5200 & RVG 6200

To acquire a single image using RVG 142, RVG 5200 and RVG 6200, follow these steps:

1. Tell the patient to remain still.
2. Position yourself either two meters behind the X-ray source or outside the door.



IMPORTANT: Make sure you can keep visual contact with the patient during the X-ray.

3. In the Dental Imaging Software toolbar, make sure that the  icon is displayed indicating that the RVG sensor is connected to the workstation and is ready for acquisition.
4. Trigger the X-ray with the remote control of the X-ray source.

The image is immediately displayed in the Imaging Window (Dental Imaging Software).

5. Check the image and if the quality is:
 1. Not satisfactory, for example, if the exposure quality indicator is red, retake the X-ray.
 2. Satisfactory, remove the X-ray source tube head.



Ideal image quality is achieved when the Control Panel exposure indicator is a full green bar. This example shows the RVG 6200 Control Panel with exposure indicator (A). Avoid under-exposed or over-exposed images indicated by a partial or full red bar:

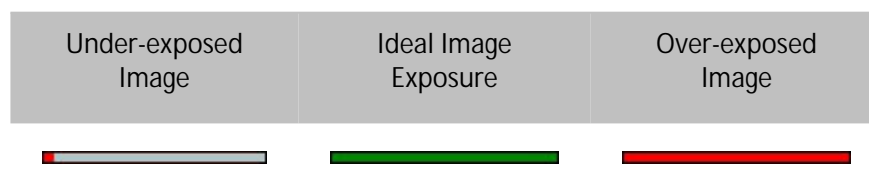

6. Remove the RVG sensor from the mouth of the patient.
7. Remove the hygienic sensor protection and throw it away.



IMPORTANT: Do NOT pull the RVG sensor by its cable when you remove the hygienic protection.

8. Clean and disinfect the RVG sensor after each patient (see the *RVG 142, RVG 5200 and RVG 6200 Safety, Regulatory, and Technical Specifications User Guide (SM847)*).
9. If required, use the CS Adapt Library software in CS Imaging Software to manage the sensor brightness/contrast filters (RVG 6200 only) as follows:
 1. Create custom filters by copying and editing existing factory preset filters.
 2. Use the Favorite function to select which filters are displayed in the Control Panel.
 3. Use the Acquisition Default function to automatically apply the selected filter at acquisition time.
 4. Import or export filter libraries.

Preparing Acquisition of FMS Images Using RVG 142, RVG 5200 & RVG 6200

To prepare the acquisition of FMS images using RVG 142, RVG 5200 and RVG 6200, follow these steps:

1. Select the appropriate size of RVG sensor (see Types of Sensor).
2. Connect the RVG sensor to a USB 2.0 port that is connected directly to the motherboard (generally located on the back of the workstation).

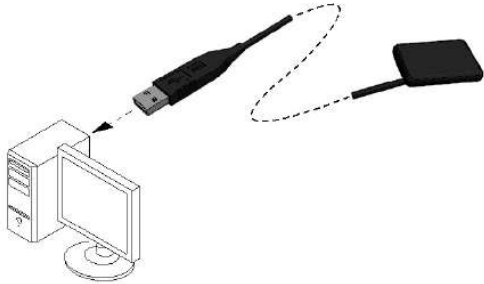

IMPORTANT: To ensure the best quality images, you must connect the RVG sensor to a USB 2.0 port that is connected directly to the motherboard (generally located on the BACK of the workstation).

3. Access the Imaging Window from the patient file.
4. Click  in the Imaging Window to access the RVG FMS Acquisition interface.



is displayed in the RVG FMS Acquisition interface indicating that the RVG sensor is connected to the workstation and is ready for acquisition.

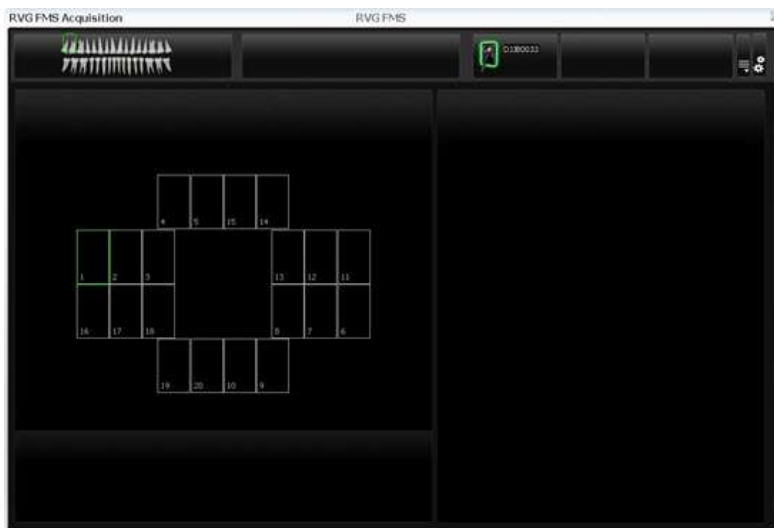

4. Select an appropriate positioner for the region of interest and the size of the RVG sensor.
5. Cover the RVG sensor with a disposable hygienic sleeve specifically designed for each size of RVG sensor.

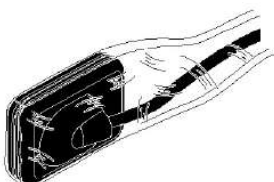



IMPORTANT: Use a NEW hygienic sleeve for each new patient to prevent cross-contamination.

7. Place the protected RVG sensor in the biteblock of the RVG sensor positioner.

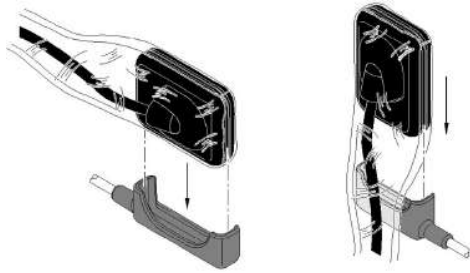

8. Position the RVG sensor in the mouth of the patient depending on the region of interest.

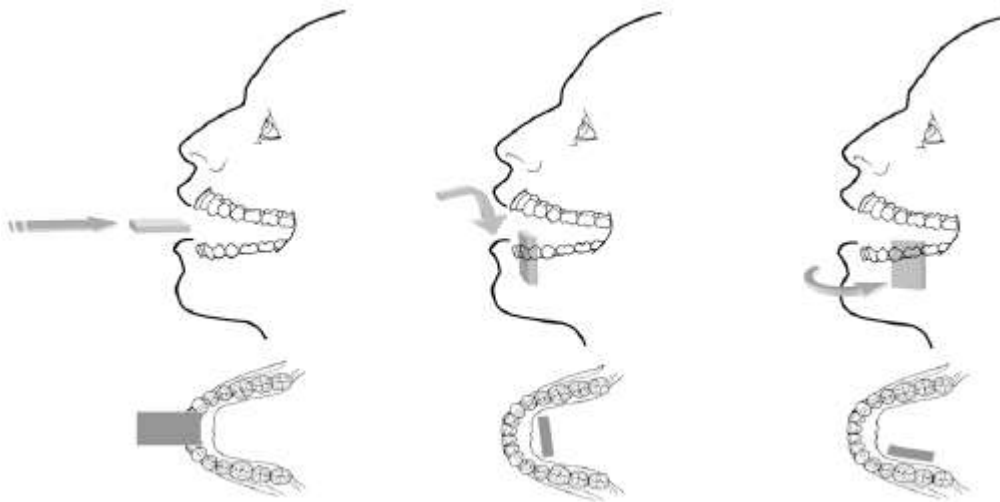

IMPORTANT: Always insert the RVG sensor holding it horizontally for the comfort of the patient.

9. Move the X-ray source tube head to the patient and align it with the tooth of the patient and the RVG sensor.



IMPORTANT: Make sure that the tube head is not shaking.

10. Select the X-ray exposure time according to the region of interest and the patient type.

FMS Images X-ray Exposure Times

Follow the user instructions of your X-ray source. The following tables provide guidelines for exposure times for an X-ray source at 70 kV and 7 mA. Add your values for the exposure time in seconds in the column on the right. If your time values are different from the suggested time values, adapt your time values until you find the best setting for your diagnostic.

Table 3 ADULT exposure times

Acquisition Mode	Suggested Exposure Time in Seconds	Your Exposure Time in Seconds
Upper incisor/canine	0.18	
Upper premolar	0.24	
Upper molar	Up to 0.40	
Lower incisor/canine	0.12	
Lower premolar	0.18	
Lower molar	0.24	

Table 4 CHILD exposure times

Acquisition Mode	Suggested Exposure Time in Seconds	Your Exposure Time in Seconds
Upper incisor/canine	0.11	
Upper premolar	0.15	
Upper molar	0.24	
Lower incisor/canine	0.075	
Lower premolar	0.11	
Lower molar	0.15	



IMPORTANT: These are suggested exposure times and need to be adjusted for your specific X-ray source. For dark images, reduce the exposure time and for grainy images, increase the exposure time.

Acquiring FMS Images Using RVG 142, RVG 5200 & RVG 6200

To acquire FMS images using RVG 142, RVG 5200 and RVG 6200, follow these steps:

1. Tell the patient to remain still.
2. Position yourself either two meters behind the X-ray source or outside the door.



IMPORTANT: Make sure you can keep visual contact with the patient during the X-ray.

3. Make sure the sensor is active.  should be displayed in the RVG FMS Acquisition interface (A).

The first empty frame in the FMS acquisition sequence is highlighted in green (C).

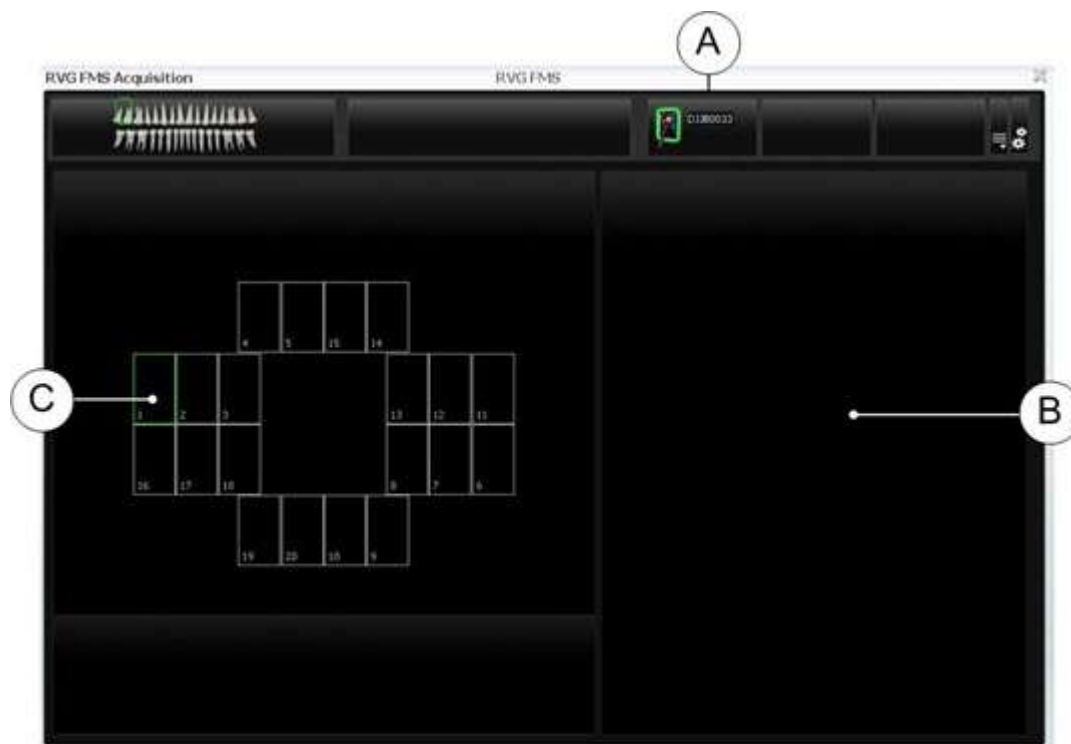

4. Trigger the X-ray with the remote control of the X-ray source.
The first acquired image will be displayed in the FMS frame (C) and the preview screen (B).
Then the next empty frame in the RVG FMS Acquisition interface is automatically highlighted in green, ready for the next acquisition.
5. Continue acquiring images until the whole FMS template is completed.
6. Check the image and if the quality is:
 1. Not satisfactory, for example, if the exposure quality indicator is red, retake the X-ray (see [Retaking FMS Images with RVG 142, RVG 5200 and RVG 6200](#)).
 2. Satisfactory, remove the X-ray source tube head.

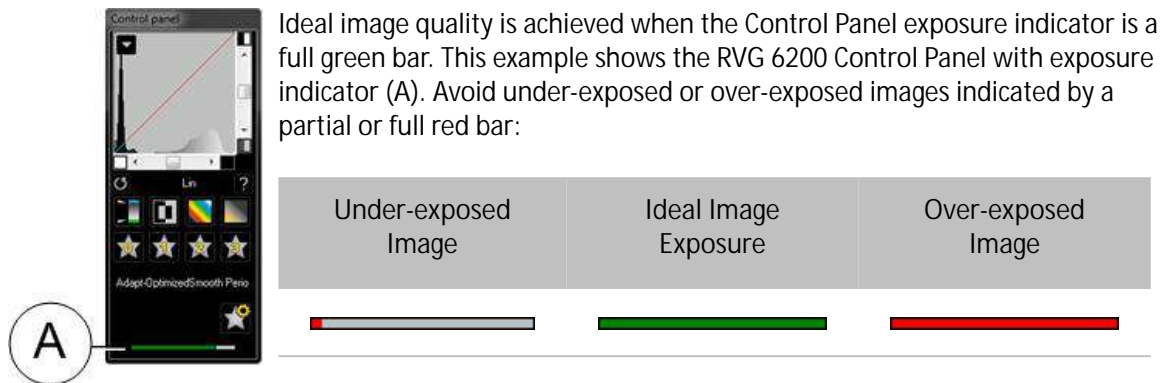

7. Remove the RVG sensor from the mouth of the patient.
8. Remove the hygienic sensor protection and throw it away.



IMPORTANT: Do NOT pull the RVG sensor by its cable when you remove the hygienic protection.

9. Clean and disinfect the RVG sensor after each patient (see the **RVG 142, RVG 5200 and RVG 6200 Safety, Regulatory, and Technical Specifications User Guide (SM847)**).
10. If required, use the CS Adapt Library software to manage the brightness/contrast filters (RVG 6200 only).
In CS Imaging Software, you can use the CS Adapt Library software to manage the brightness/contrast filters as follows:
 - Create custom filters by copying and editing existing factory preset filters.
 - Use the Favorite function to select which filters are displayed in the Control Panel.
 - Use the Acquisition Default function to automatically apply the selected filter at acquisition time.
 - Import or export filter libraries.

Retaking FMS Images with RVG 142, RVG 5200 and RVG 6200

If you need to retake images, the sensor must be active.

To retake images, follow these steps:

1. Click to select the FMS frame you want to check.

A frame that already contains an image is highlighted in blue (D), and the image is displayed in the preview screen (B).

2. Check the image quality in the preview screen (B).

3. If you decide to retake the image, make sure the sensor is active (see (A) in [Acquiring FMS Images Using RVG 142, RVG 5200 & RVG 6200](#)).

4. Reposition the sensor and use the trigger to retake the image.

The new image is displayed in the selected frame (D), and a blue dot is displayed in the frame to show that it contains retake images.

The FMS retake image gallery (C) is displayed and only displays images acquired for the selected frame (D).



The retake images are automatically saved unless you want to select and delete them.

If required, select an image and adjust brightness  or contrast . Click  to reset your adjustments. These controls are displayed when you move your mouse over the image preview frame (B). Image brightness and contrast adjustments are automatically saved.





Note: By retaking images before the FMS acquisition has completed, you will interrupt the automatic acquisition sequence. To restart the automatic acquisition, click the next empty frame in the acquisition sequence.

5. If you want to set your image adjustments to default, click (A).

The CS Adapt Library window appears:



6. Click  and set your default adjustments. Click Save and Exit.
7. When the FMS acquisition is complete, click  to exit the RVG FMS Acquisition interface.
 The FMS template with the acquired images and the applied image enhancements are saved and displayed in the Imaging Window.
 The retake images are also saved in the Imaging Window but not as a part of the FMS template.
8. Remove the X-ray source tube head.
9. Remove the RVG sensor from the mouth of the patient.
10. Remove the hygienic sensor protection and throw it away.



IMPORTANT: Do NOT pull the RVG sensor by its cable when you remove the hygienic protection.

11. Clean and disinfect the RVG sensor after each patient (see the **RVG 142, RVG 5200 and RVG 6200 Safety, Regulatory and Technical Specifications User Guide (SM847)**).

Setting Up and Using RVG Connect for RVG 6200

RVG Connect Overview

RVG Connect allows you to share an RVG 6200 sensor between several workstations without having to move it from workstation to workstation. The RVG sensor is automatically recognized and operational when you connect it to the RVG Connect unit. Each workstation must:

- Have CS Imaging Software and corresponding drivers installed.
- Be connected to a local area network (LAN).

RVG Connect Hardware Overview

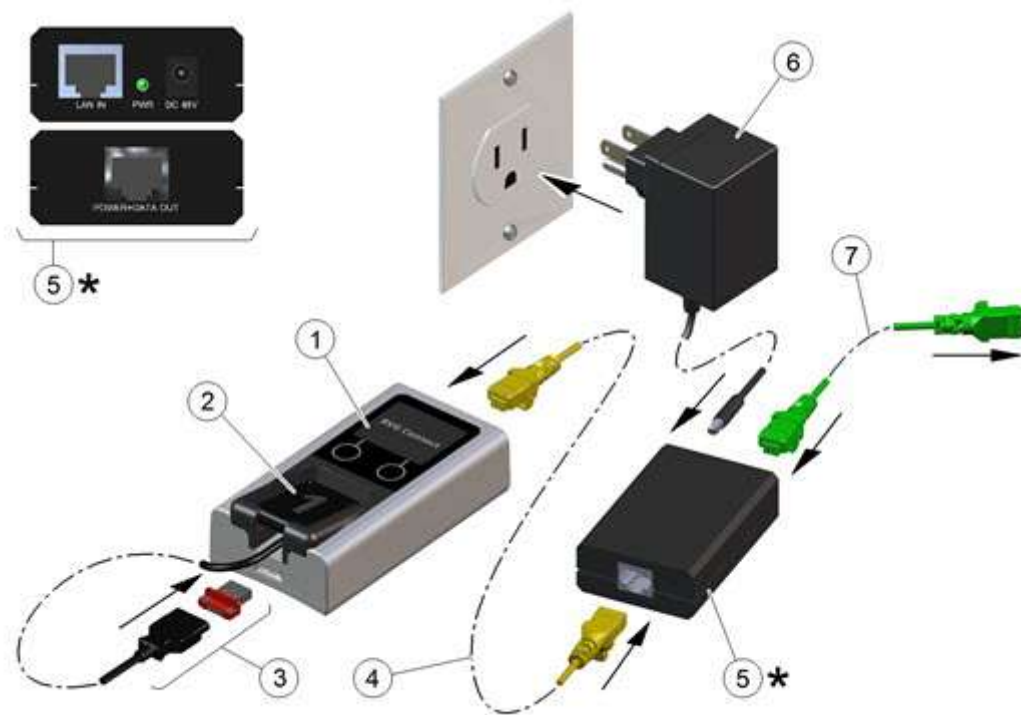

1	RVG Connect unit.	2	RVG 6200 sensor specific to RVG Connect with a magnetic USB 2.0 connector.
3	USB 2.0 magnetic connector for RVG 6200 sensor.	4	Ethernet cable connecting the RVG Connect unit to the PoE Injector (power over Ethernet).
5	PoE Injector (power over Ethernet). This needs to be located near a power socket. <ul style="list-style-type: none">• Red LED indicates that the RVG Connect unit is not connected.• Green LED indicates that the RVG Connect unit is connected.	6	Power adapter for the PoE Injector.
7	Ethernet cable connecting the PoE Injector to the LAN, or an Ethernet hub, or a workstation with two Ethernet cards.		

After three minutes of inactivity, the RVG Connect unit goes into standby mode. The RVG Connect unit is automatically reactivated when you acquire an image. You can also touch any button to reactivate the RVG Connect unit.

RVG Connect Unit Overview

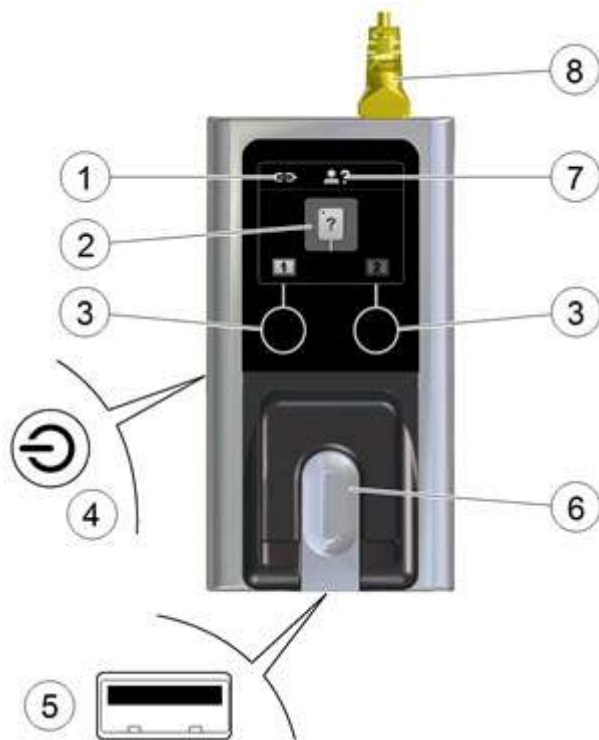

1 Indicates whether the RVG Connect unit is paired with the workstation:

- : RVG Connect unit is not paired with a workstation.
- : RVG Connect unit is paired with a workstation but there is no communication between the RVG Connect unit and the workstation.
- : RVG Connect unit is paired with a workstation and there is communication between the RVG Connect unit and the workstation.

2 Indicates the status of the RVG Connect unit and sensor:

- : No RVG sensor is plugged in.
- : RVG sensor is initializing.
- : RVG sensor is initialized.
- : RVG sensor is ready for acquisition.
- : Error

3 Touch sensitive buttons allow you to:

- Change the workstation that the RVG Connect unit is paired with.
- Navigate through the menus of the RVG Connect unit.

4 Power and menu button.

- A long press of the button switches the RVG Connect unit on or off.
- A short press of the button displays the menu and activates choices you make.

5 USB 2.0 port for the RVG sensor

6 RVG sensor holder

7 indicates that the patient name has not yet been received from the workstation.

Once the patient name is received from the workstation, the screen displays the patient name at the top as in this example:



8 Ethernet cable connecting the RVG Connect unit to the PoE Injector (power over Ethernet).

After three minutes of inactivity, the RVG Connect unit goes into standby mode. The RVG Connect unit is automatically reactivated when you acquire an image. You can also touch any button to reactivate the RVG Connect unit.

RVG Connect Menu



Navigating the Menu

To navigate the menu on the RVG Connect unit, follow these steps:

1. Press the power and menu button briefly.







The menu is displayed. This example shows the network information at the top of the screen (see).



 and  are displayed above the touch sensitive buttons.

2. Press the touch sensitive buttons on the front of the RVG Connect unit to navigate the menu.
3. Press the power and menu button briefly again to select a menu item.

RVG Connect Menu Items

Icon	Explanation
	Exits menu and returns to the main screen.
	Sets the default static IP address (192.168.17.3). See Assigning Default Static IP Address with Automatic Device Detection .
	Activates the DHCP configuration (automatic attribution of an IP address). See Activating DHCP Configuration .
	Allows you to manually assign a static IP address. See Manually Assigning Static IP Address .
	Displays the IPv6 address, prefix, and scope. This is useful if you are using IPv6 without Bonjour. By default, an RVG Connect unit has one IPv6 address (link-local). For an RVG Connect unit with several IPv6 addresses, the information is displayed on several screens. Press the touch sensitive button under  to display the next screen.

Imaging Software Overview

Computer System Requirements

Minimum computer system requirements for RVG 142, RVG 5200 and RVG 6200 are given in the **RVG 142, RVG 5200 and RVG 6200 Safety, Regulatory and Technical Specifications User Guide (SM847)**. If necessary you must update your computer system configuration.

General Software Overview

RVG 142, RVG 5200 and RVG 6200, and RVG Connect operate with CS Imaging Software. You can acquire:

- Single images
- Full mouth series (FMS)





Single Image Acquisition Overview

You can acquire individual images using CS Imaging Software.

Figure 2 CS Imaging Software with One Active RVG Sensor Connected



CS Imaging Software can display up to three RVG sensors connected to the workstation. The color of the RVG icon shows connection status:

Icon	Explanation
	Displays the RVG Sensor list so that you can pair the RVG Connect sensor plugged into the RVG Connect unit with this workstation. See Pairing RVG Connect Units with a Workstation .
	RVG Connect unit or RVG sensor are connected to the workstation and are ready for image acquisition.
	Displayed when the RVG Sensor list is open and indicates that the RVG Connect unit is connected to the workstation but is not ready for image acquisition. See Pairing RVG Connect Units with a Workstation .
	RVG sensor is connected to the workstation but an error has occurred. An error message will be displayed in a popup window.

Setting Up RVG Connect

Installing the RVG Connect Driver

To install the RVG Connect driver, follow these steps:

1. Insert the Drivers DVD-ROM (2/2) in the DVD-ROM drive.

The Installer Language dialog box is displayed.



2. Select the installer language and click OK.

The Welcome to the RVG Driver Setup Wizard dialog box is displayed.

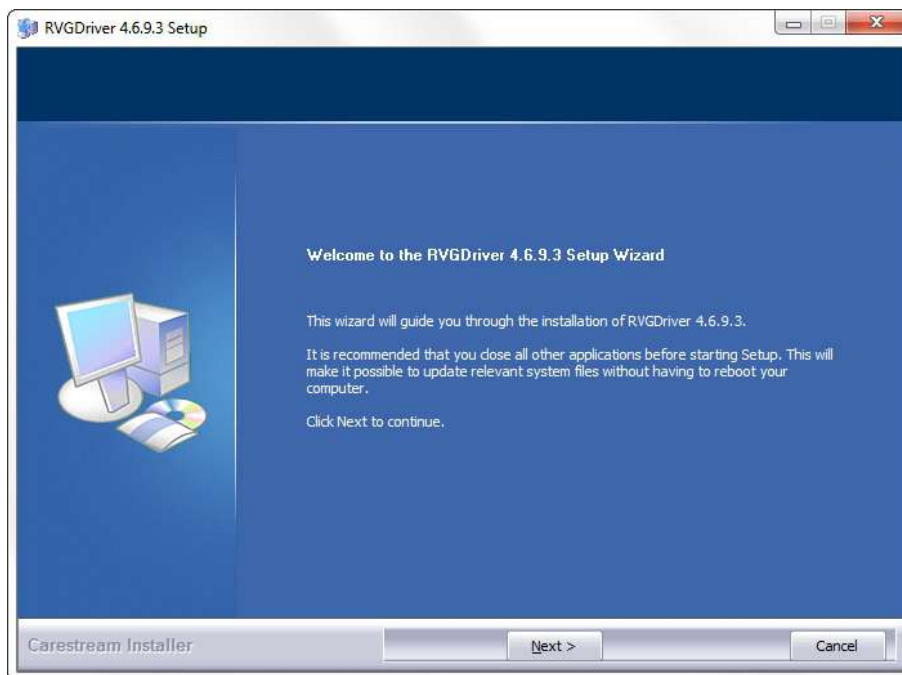

3. Click Next.

The Choose Components dialog box is displayed.



IMPORTANT: Do NOT uncheck any boxes that are already checked.

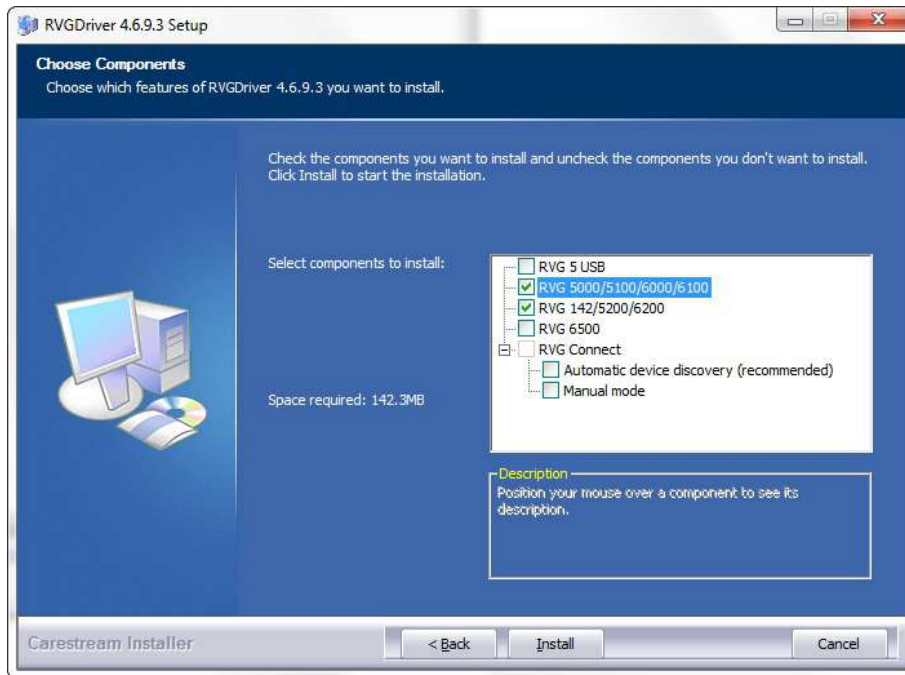

4. Under RVG Connect, select one of the following mode options:

Mode	Explanation
Automatic device discovery (recommended)	<p>Selecting this option will configure RVG Connect differently depending on your computer's configuration:</p> <ul style="list-style-type: none"> • EITHER Fully automatic <ul style="list-style-type: none"> Uses Bonjour to automatically detect device and uses DHCP (dynamic host configuration protocol) so manual static IP address assignment is not required. See . • OR Automatic device detection and static IP address entry <ul style="list-style-type: none"> Uses Bonjour to automatically detect the device and allows you to assign a static IP address. You can: <ul style="list-style-type: none"> ◦ Either use the default IP address assigned to the RVG Connect unit (192.168.17.3). See Assigning Default Static IP Address with Automatic Device Detection. ◦ Or manually enter an available IP address. See Manually Assigning Static IP Address.
Manual mode	<p>Manual workstation configuration with a static IP address using the RVG Service Tools (used when Bonjour is not installed). See Assigning IP Addresses to RVG Connect Unit Using RVG Service Tools without Bonjour.</p>

5. Click Install.

The Installing dialog box is displayed.

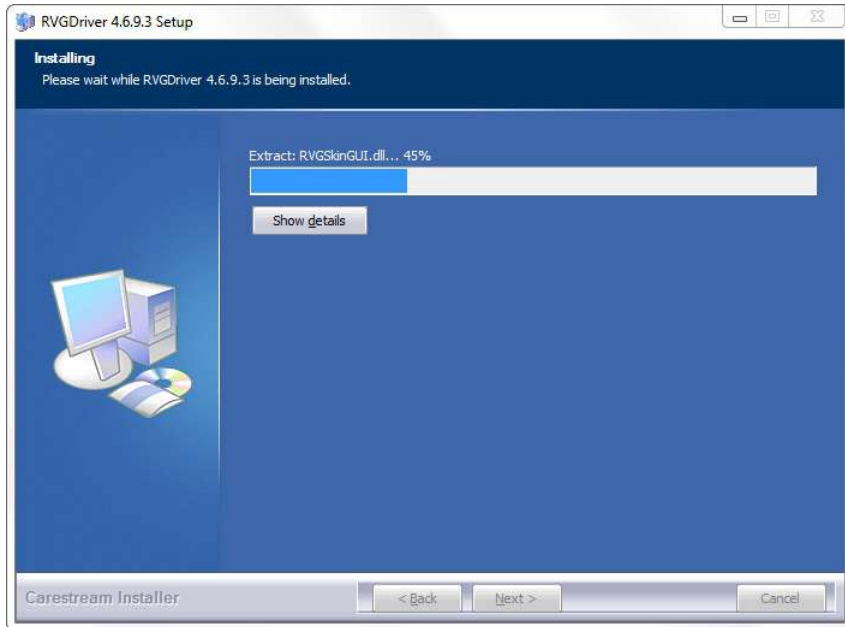

When the installation is complete, the Completing the RVG Setup Wizard dialog box is displayed.

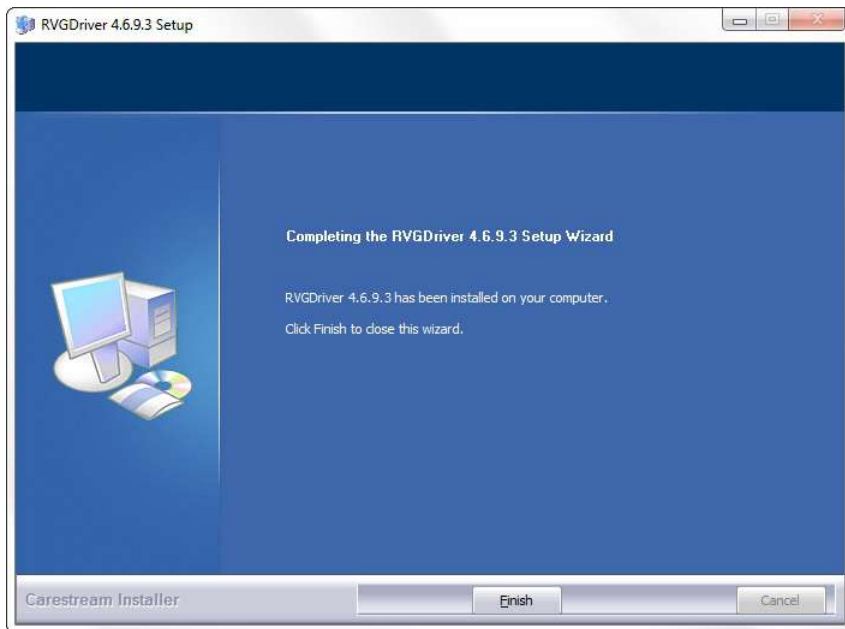

6. Click Finish.



Installing RVG Connect Hardware



WARNING: The arm of the X-ray source assembly **MUST** be adjustable. Not all models can be adjusted. The additional weight of the RVG Connect unit may mean you have to adjust the arm so that it is stabilized.

To install the RVG Connect hardware, follow these steps:

1. Position the PoE Injector (power over Ethernet) near an electrical power socket.

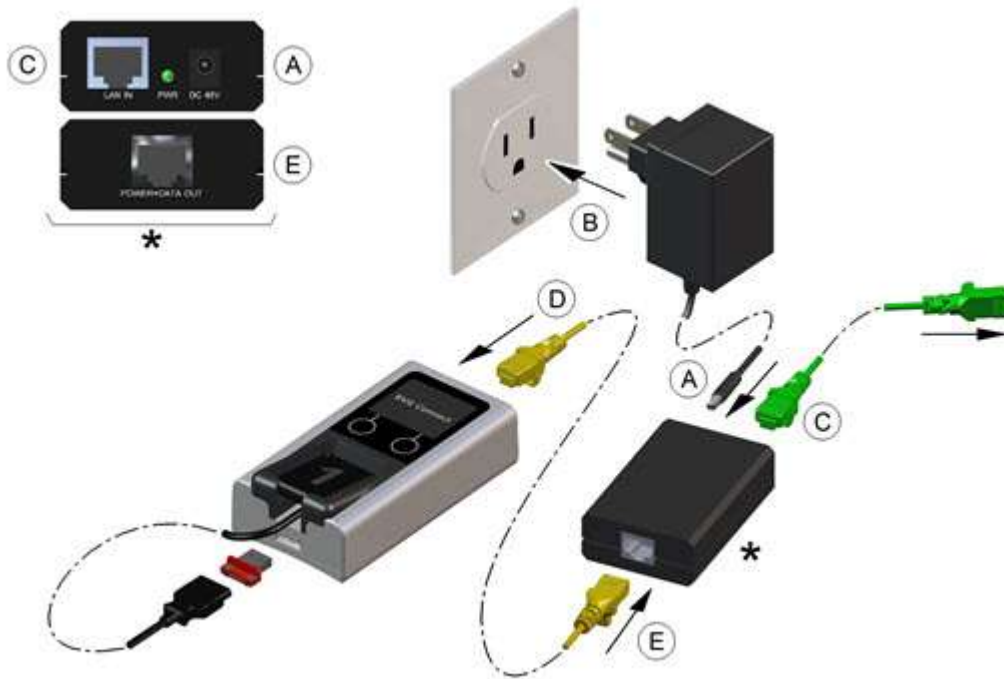

2. Plug the power lead into the PoE Injector (power over ethernet) (A).
3. Plug in the power adapter for the PoE Injector (B).
The LED on the end of the PoE Injector is red.
4. Plug the ethernet cable from the local area network, or ethernet hub, or from a workstation with two ethernet cards, into the LAN IN ethernet port on the PoE Injector (C).
5. Plug the ethernet cable from the RVG Connect unit (D) into the POWER+DATA OUT ethernet port on the PoE Injector (E).
The LED on the end of the PoE Injector changes from red to green.
6. Press the power button on the side of the RVG Connect unit and check that the unit is functioning.
7. Clean the X-ray source assembly tube head with disposable cleaning wipes.
8. Remove the protective tape from the two self-adhesive pads on the back of the RVG Connect unit.
9. Using the adhesive pads, carefully attach the RVG Connect unit onto the X-ray source assembly, for example, at position (A).



Note: This illustration is an example as X-ray source assemblies vary. In some cases, you can also attach the Ethernet cable to the side of the arm instead of the top. However, you must leave enough slack in the cable at each moving joint of the arm to allow free movement.

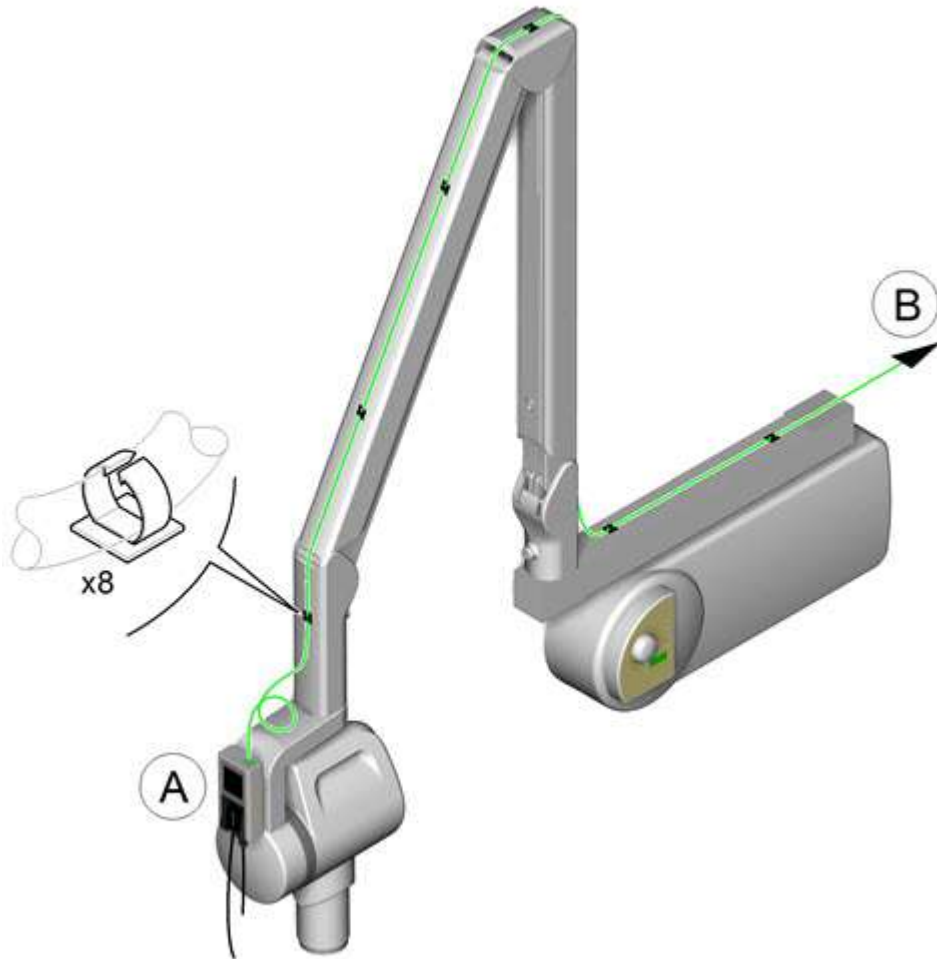

You can use the optional bracket if the X-ray source assembly has a curved surface:

- Attach the bracket to the X-ray source assembly using two cable ties that are supplied with the bracket.
- Carefully stick the RVG Connect unit onto the bracket

10. Check the stability of the arm of the X-ray source assembly and adjust it if necessary.
11. Attach the ethernet cable (B) to the arm of the X-ray source assembly using self adhesive cable hooks and cable ties.



IMPORTANT: Leave enough slack in the cable at each moving joint of the arm to allow free movement of the X-ray source.

12. Check that the workstation is connected to the local area network with an ethernet cable.

Network Configuration

You can configure RVG Connect using one of three modes:

Mode	Explanation
Fully automatic DHCP: 10.96.82.31 00:1d:4a:01:7e:dd	Uses Bonjour to automatically detect device and uses DHCP (dynamic host configuration protocol) so manual static IP address assignment is not required. See: <ul style="list-style-type: none">• Checking Dynamic Attribution of IP Address• Activating DHCP Configuration Activating the DHCP Configuration
Automatic device detection and static IP address 192.168.17.3 00:1d:4a:01:7e:dd	Uses Bonjour to automatically detect the device and allows you to assign a static IP address. You can either: <ul style="list-style-type: none">• Use the default IP address (192.168.17.3) assigned to the RVG Connect unit (see Assigning Default Static IP Address with Automatic Device Detection).• Manually enter an available IP address (see Manually Assigning Static IP Address).
Manual 182.188.10.4 00:1d:4a:01:7e:dd	Manual workstation configuration with a static IP address using the RVG Service Tools; this is used when Bonjour is not installed (see Assigning IP Addresses to RVG Connect Unit Using RVG Service Tools without Bonjour). Alternatively you can manually enter an available IP address directly on the RVG Connect unit (see Manually Assigning Static IP Address).

Checking Dynamic Attribution of IP Address

To check that DHCP is active on the RVG Connect unit, follow these steps:



1. Press the menu button on the side of the RVG Connect unit.
2. Check that the top of the screen displays DHCP followed by the IP address of the RVG Connect unit and the MAC address on the second line.

At first the IP address is not displayed as in the example on the left then after a few moments the IP address is displayed as in the example on the right.





Activating DHCP Configuration

At any time you can activate the DHCP configuration (automatic device detection and attribution of an IP address) by following these steps:

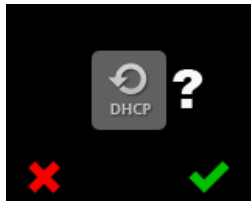
1. Briefly press the menu button on the side of the RVG Connect unit.
2. Press the left touch sensitive button under  until  is displayed on the screen.
3. Briefly press the menu button on the side of the RVG Connect unit.



 above the left touch sensitive button cancels the procedure.

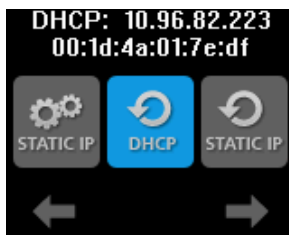

4. Press the right touch sensitive button under .

When the processing is completed the following information is displayed at the top of the screen.



Assigning Default Static IP Address with Automatic Device Detection

To assign the default static IP address using automatic device detection, follow these steps:

1. Briefly press the menu button on the side of the RVG Connect unit.
2. Press the left touch sensitive button under  until  is displayed on the screen.
3. Briefly press the menu button on the side of the RVG Connect unit.

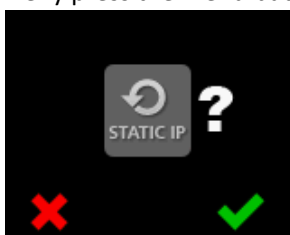

 above the left touch sensitive button cancels the procedure.

4. Press the right touch sensitive button under .

The RVG Connect unit automatically restarts.

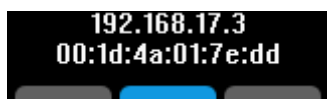

5. Briefly press the menu button on the side of the RVG Connect unit.

The following information is displayed at the top of the screen:



Manually Assigning Static IP Address

To manually assign a static IP address to the RVG Connect unit, follow these steps:

1. Briefly press the menu button on the side of the RVG Connect unit.
2. Press the left touch sensitive button under  until  is displayed on the screen.
3. Briefly press the menu button on the side of the RVG Connect unit.





4. Press the left touch sensitive button below .

A cursor in the form of a small blue line is displayed under the first digit of the IP address.



You can either press the:

- right touch sensitive button below  to increase the value of this digit.
- left touch sensitive button below  to move the cursor to the next digit.

5. Once you have entered the desired information, press the left touch sensitive button below  to move the cursor under .

You can position the cursor under and briefly press the menu button on the side of the RVG Connect unit to cancel the configuration.

6. Press the right touch sensitive button below .

The RVG Connect unit automatically restarts.

7. Briefly press the menu button on the side of the RVG Connect unit.
The manually entered IP address is displayed at the top of the screen.

Assigning IP Address to RVG Connect Unit Using RVG Service Tools with Bonjour



IMPORTANT: This procedure assumes that you chose Automatic Device Discovery (recommended) when you installed the RVG Connect driver.

The RVG Service Tools displays a list of all the RVG Connect units and their IP addresses detected by Bonjour. You can either:

- Obtain an IP address automatically.
- Manually enter the IP Address, Subnet Mask, and Default Gateway.

To assign an IP address to the RVG Connect unit using the RVG Service Tools, follow these steps:

1. Click  on your desktop to start the RVG Service Tools.
2. Select RVG Sensors.

The Service Tools home page is displayed.

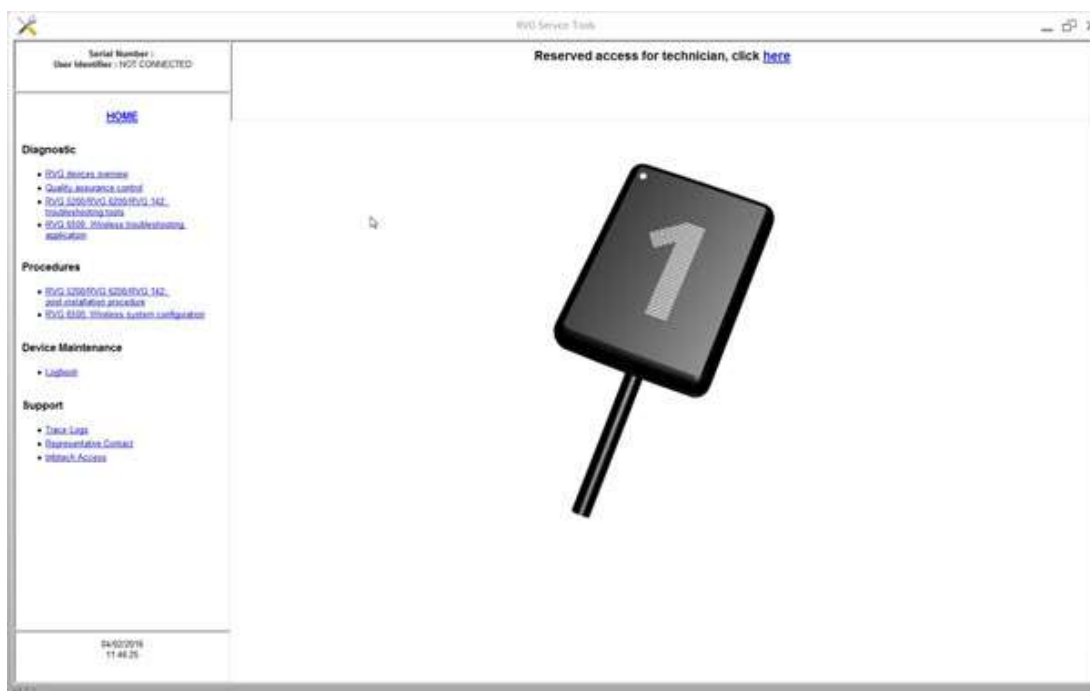

3. Click RVG Connect: Network Configuration under Procedures.
4. Under Network Configuration, either:
 1. Click Obtain an IP address automatically, then click Apply.
 2. Manually enter the IP Address, Subnet Mask, and Default Gateway, then click Apply.

Assigning IP Addresses to RVG Connect Unit Using RVG Service Tools without Bonjour



IMPORTANT: This procedure assumes that you chose Manual mode when you installed the RVG Connect driver.

To manually assign an IP address to the RVG Connect unit using the RVG Service Tools, follow these steps:

1. Verify that the RVG Connect unit has the default IP address 192.168.17.3.

This is the factory default. If this is not the case, see [Manually Assigning Static IP Address](#).

2. Click  on your desktop to start the RVG Service Tools.
3. Select RVG Sensors.

The Service Tools home page is displayed.

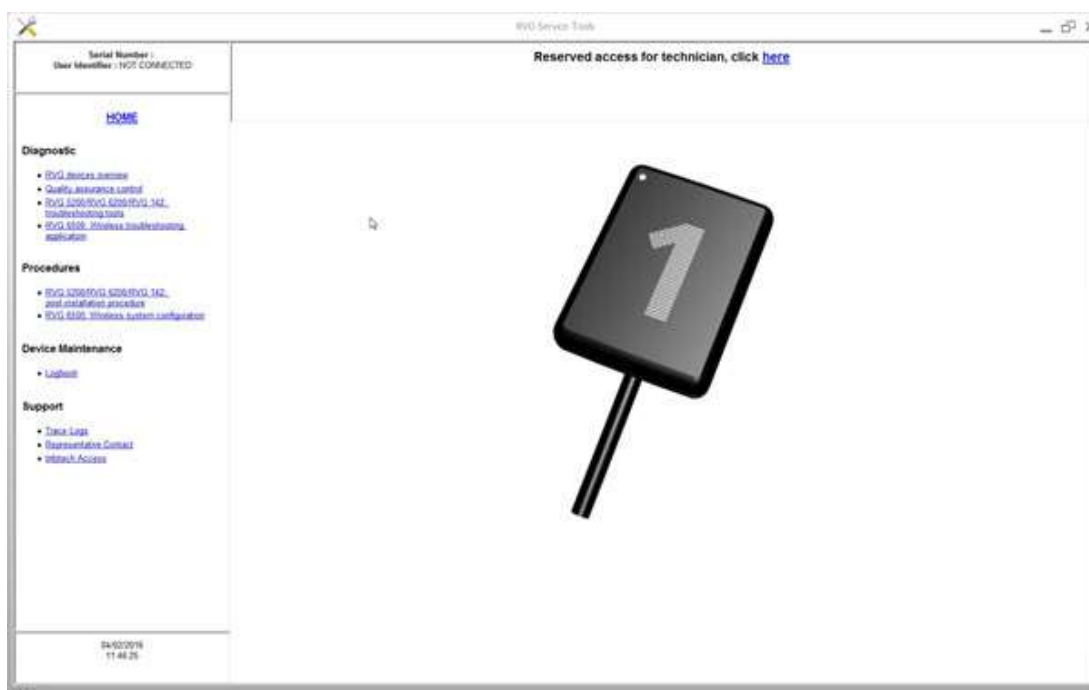

4. Click RVG Connect: Network Configuration under Procedures.
5. Click Configure.
 1. The first page explains how to configure the network of the workstation using Microsoft Windows tools.
 2. The second page explains the hardware connections and how to put the RVG Connect unit into IP static mode.
 3. The third page allows you to assign a specific IP address to the RVG Connect unit.
6. Follow the instructions on screen.

Managing List of IP Addresses for Use on Several Workstations

To manage a list of IP addresses that you can assign to RVG Connect units and share with other workstations, follow these steps:

1. Click  on your desktop to start the RVG Service Tools.
2. Select RVG Sensors.

The Service Tools home page is displayed.

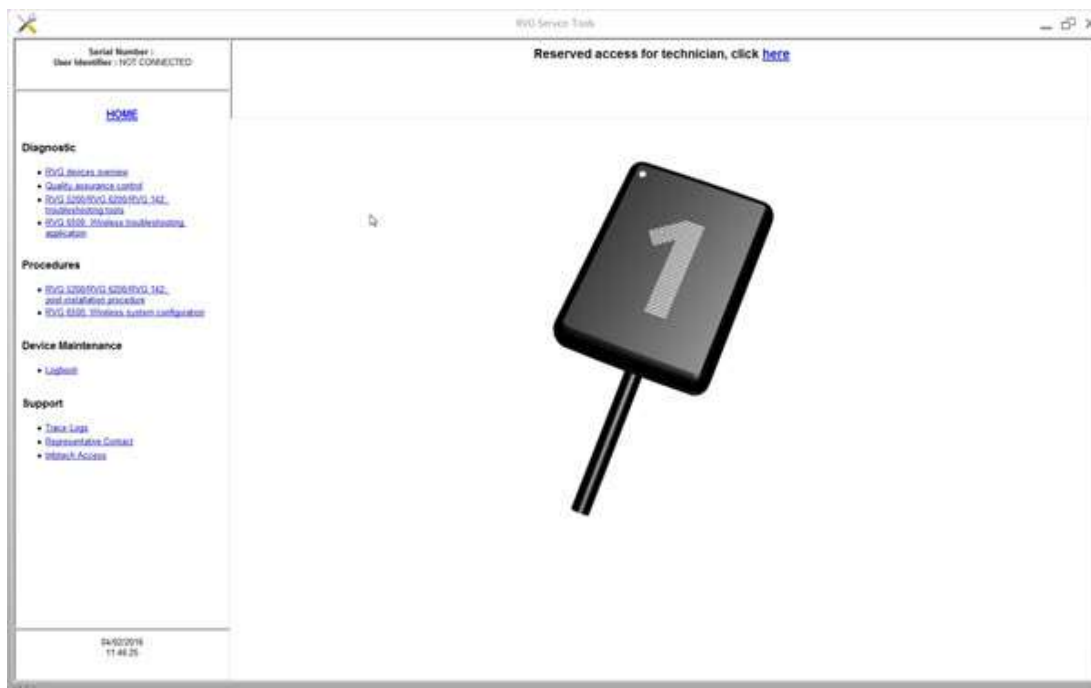

3. Click RVG Connect: Network Configuration under Procedures.
4. Click Manage.

The Manage function:

- Displays a list of known RVG Connect units that can be seen from the workstation.
- Allows you to remove IP addresses from the list.
- Allows you to manually add new devices by entering either an IPv6 address or an IPv4 IP address, subnet mask, and default gateway.
- Allows you to import or export the list as a file. This option is useful for a network manager who wants to manage the list for several workstations.

Pairing RVG Connect Units with a Workstation

Before you can use an RVG Connect connect unit, it must be paired with your workstation.

To pair an RVG Connect unit with a workstation, follow these steps:

1. In the main toolbar in CS Imaging Software, click .

The Sensor list is displayed:



The screenshot shows a 'Sensor list' window with three entries. The first entry is 'Carp', which is 'Locked on MARU0064' and has an 'unlock' button. The second entry is 'Lulu', which is 'Locked on MARC2031' and has an 'unlock' button. The third entry is 'Lulu', which is 'Available' and has a 'lock' button. Each entry has a small icon of the unit and a status indicator (a red 'X' for locked, a green checkmark for available).

In this example, the Sensor list contains three RVG Connect units:

- The first unit has already been paired with a different workstation (note the unlock button), and it does not have a sensor connected to it.
- The second unit has already been paired with a different workstation (note the unlock button).
- The third unit is available for pairing on this workstation (note the lock button).

2. In the Sensor list, locate the RVG Connect unit and the RVG Sensor that you want to use.

If it has already been paired on a different workstation, click .

On the RVG Connect unit, the unlock confirmation screen is displayed:

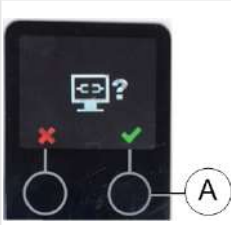

The screenshot shows a screen with a computer icon and a question mark. Below it are two circular buttons: one with a red 'X' and one with a green checkmark. A white circle with the letter 'A' is positioned to the right of the green checkmark button.

Note: This unlock confirmation screen is only displayed for a few seconds. If it disappears, click  again.

3. On the RVG Connect unit, click (A) to confirm that you want to unlock this unit.
4. In the Sensor list, click  to pair the selected RVG Connect unit with your workstation.

The Sensor list is updated and displays the status Locked on this computer.



This indicates that the RVG Connect unit and RVG Sensor are paired with this workstation.

Associating Buttons on RVG Connect Unit with Workstation (Optional)

After you have paired an RVG Connect unit with a workstation, you can optionally associate one or two buttons on the RVG Connect unit with that workstation.

Press either button **1** or button **2** on the front of the RVG Connect unit for a few seconds to pair the workstation with that button.



Initializing the RVG Sensor with RVG Connect for First Time

Initializing the RVG Sensor With RVG Connect for the First Time

To initialize the RVG sensor with RVG Connect for the first time, follow these steps:

1. Start CS Imaging Software and select a patient.
2. Switch on the RVG Connect unit by pressing the power switch on the left side of the RVG Connect unit.

Wait a few seconds for the unit to initialize.

The RVG Connect screen displays:



 indicates that no RVG sensor is plugged in.

3. Place the RVG sensor in the sensor holder on the RVG Connect unit.
4. Plug the RVG sensor into the USB 2.0 port under the RVG Connect unit.

The RVG Connect screen displays  indicating that the RVG sensor is initializing.

5. Wait for the initialization process to complete.



Note: The first time you plug an RVG sensor into the RVG Connect unit, it can take awhile to initialize.

The RVG Connect screen displays:



 indicates that the RVG sensor is initialized.

Preparing Acquisition of Single Image Using RVG Connect

To prepare the acquisition of a single image using RVG Connect, follow these steps:

1. Check that the RVG Connect unit is paired with the workstation.
2. Optionally press either button **1** or button **2** on the front of the RVG Connect unit to select the workstation.
3. Select the appropriate size of RVG sensor.
See [RVG 142, RVG 5200 and RVG 6200 Overview](#).
4. Plug in the RVG sensor to the RVG Connect unit.
5. Wait for the RVG sensor to initialize.



RVG Connect indicates that the system is ready to acquire images. The patient name is also displayed at the top of the screen on the RVG Connect unit.



You can also access the Imaging Window from the patient browser. The  icon is displayed in the Imaging Window toolbar indicating that an RVG sensor is connected to the RVG Connect unit and is ready for acquisition (see).



6. Select an appropriate positioner for the region of interest and the size of the sensor.
7. Cover the RVG sensor with a disposable hygienic sleeve specifically designed for each size of RVG sensor.

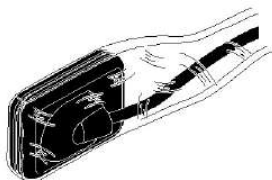

IMPORTANT: Use a NEW hygienic sleeve for each new patient to prevent cross-contamination.

8. Place the protected RVG sensor in the biteblock of the RVG sensor positioner.

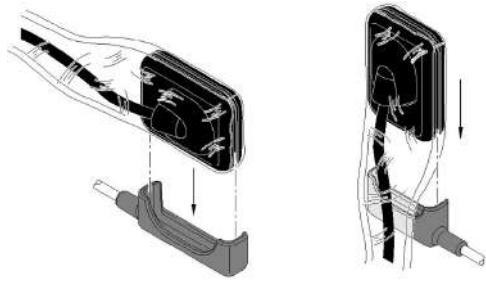

9. Position the RVG sensor in the mouth of the patient depending on the region of interest.

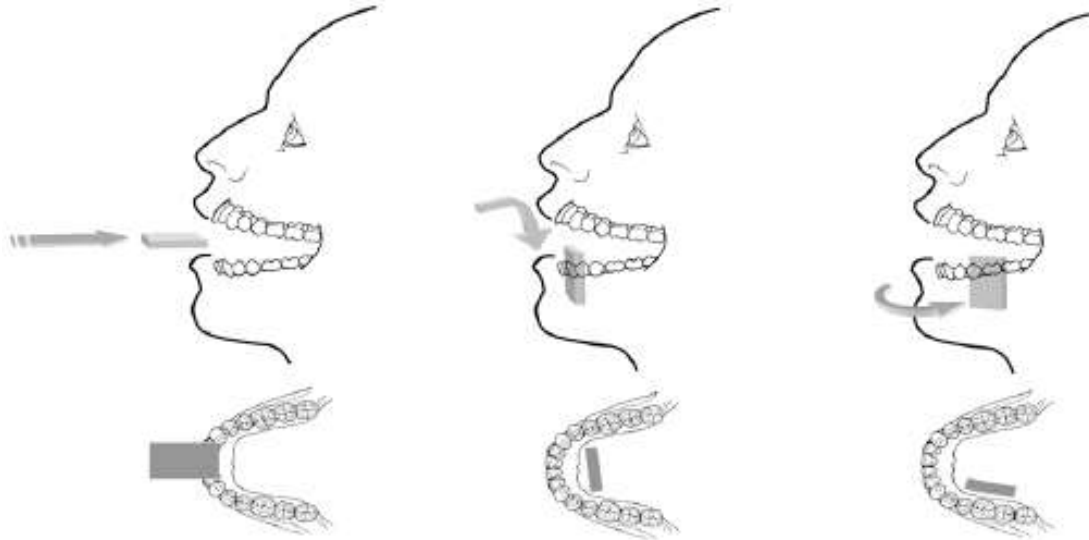

IMPORTANT: Always insert the RVG sensor holding it horizontally for the comfort of the patient.

10. Move the X-ray source tube head close to the patient and align it with the tooth of the patient and the RVG sensor.



IMPORTANT: Make sure that the tube head is not shaking.

11. Select the X-ray exposure time according to the region of interest and the patient type (see [Single Image X-ray Exposure Times](#)).

Single Image X-ray Exposure Times

Follow the user instructions of your X-ray source. The following tables provide guidelines for exposure times for an X-ray source at 70 kV and 7 mA. Add your values for the exposure time in seconds in the column on the right. If your time values are different from the suggested time values, adapt your time values until you find the best setting for your diagnostic.

Table 1 ADULT exposure times

Acquisition Mode	Suggested Exposure Time in Seconds	Your Exposure Time in Seconds
Upper incisor/canine	0.18	
Upper premolar	0.24	
Upper molar	Up to 0.40	
Lower incisor/canine	0.12	
Lower premolar	0.18	
Lower molar	0.24	

Table 2 CHILD exposure times

Acquisition Mode	Suggested Exposure Time in Seconds	Your Exposure Time in Seconds
Upper incisor/canine	0.11	
Upper premolar	0.15	
Upper molar	0.24	
Lower incisor/canine	0.075	
Lower premolar	0.11	
Lower molar	0.15	



IMPORTANT: These are suggested exposure times and need to be adjusted for your specific X-ray source. For dark images, reduce the exposure time and for grainy images, increase the exposure time.

Acquiring Single Image Using RVG Connect

To acquire a single image using RVG Connect, follow these steps:

1. Tell the patient to remain still.
2. Position yourself either two meters behind the X-ray source or outside the door.



IMPORTANT: Make sure you can keep visual contact with the patient during the X-ray.

3. Make sure that the  icon is displayed on the RVG Connect unit.

Alternatively, make sure that the  icon is displayed in CS Imaging Software toolbar indicating that the RVG sensor is connected to the workstation and is ready for acquisition.

4. Trigger the X-ray with the remote control of the X-ray source.

The screen on the RVG Connect unit indicates the transfer of the image to the workstation.



The image is then displayed in the Imaging Window.

5. Check the image and if the quality is:
 1. Not satisfactory, for example, if the exposure quality indicator is red, retake the X-ray.
 2. Satisfactory, remove the X-ray source tube head.



Ideal image quality is achieved when the Control Panel exposure indicator is a full green bar. This example shows the RVG 6200 Control Panel with exposure indicator (A). Avoid under-exposed or over-exposed images indicated by a partial or full red bar:

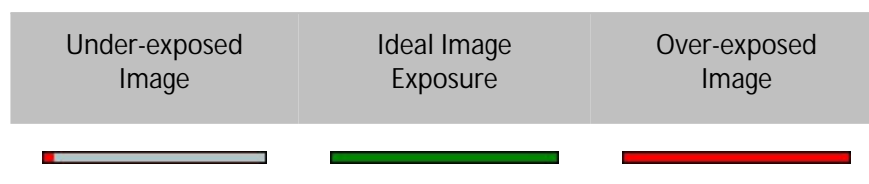

6. Remove the RVG sensor from the mouth of the patient.
7. Remove the hygienic sensor protection and throw it away.



IMPORTANT: Do NOT pull the RVG sensor by its cable when you remove the hygienic protection.

8. Clean and disinfect the RVG sensor after each patient (see the **RVG 142, RVG 5200 and RVG 6200 Safety, Regulatory, and Technical Specifications User Guide (SM847)**).
9. Use the CS Adapt Library software to manage the brightness/contrast filters.

In CS Imaging Software, you can use the CS Adapt Library software to manage the brightness/contrast filters as follows:

- Create custom filters by copying and editing existing factory preset filters.
- Use the Favorite function to select which filters are displayed in the Control Panel.
- Use the Acquisition Default function to automatically apply the selected filter at acquisition time.
- Import or export filter libraries.

Preparing Acquisition of FMS Images Using RVG Connect



To prepare the acquisition of FMS images using RVG Connect, follow these steps:

1. Check that the RVG Connect unit is paired with the workstation.
2. Optionally press either button **1** or button **2** on the front of the RVG Connect unit to select the workstation.
3. Select the appropriate size of RVG sensor (see).
4. Plug in the RVG sensor to the RVG Connect unit.
5. Wait for the RVG sensor to initialize.



RVG Connect indicates that the system is ready to acquire images. The patient name is also displayed at the top of the screen on the RVG Connect unit.



6. Access the Imaging Window from the patient file.
7. Click  in the Imaging Window to access the **RVG FMS Acquisition** interface.  is displayed in the RVG FMS Acquisition interface indicating that the RVG sensor is connected to the workstation and is ready for acquisition.

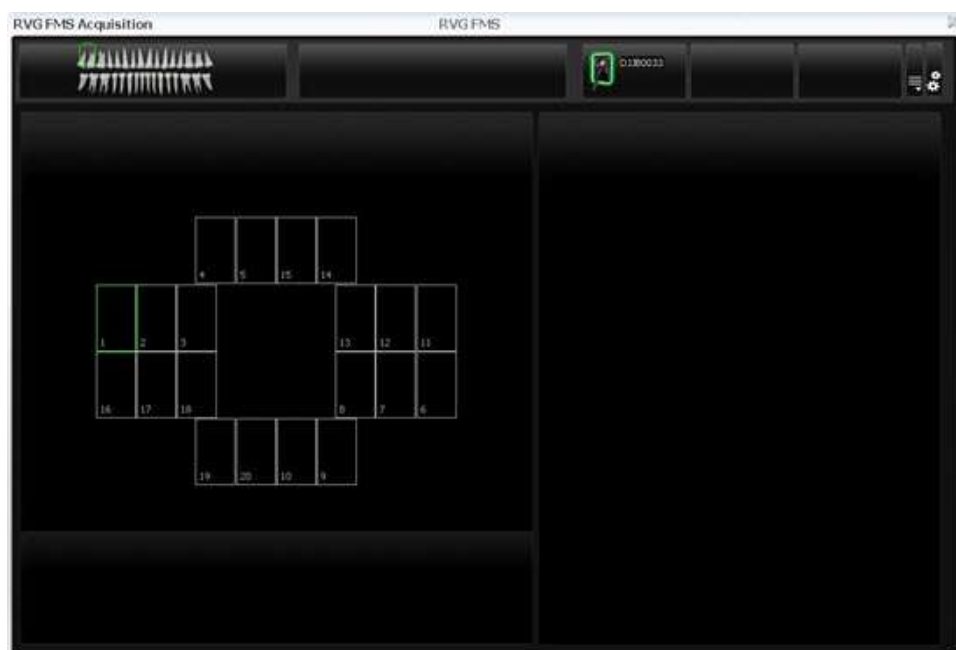

8. Select an appropriate positioner for the region of interest and the size of the RVG sensor.
9. Cover the RVG sensor with a disposable hygienic sleeve specifically designed for each size of RVG sensor.

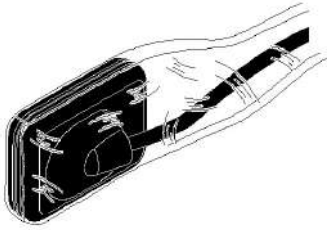

IMPORTANT: Use a NEW hygienic sleeve for each new patient to prevent cross-contamination.

10. Place the protected RVG sensor in the biteblock of the RVG sensor positioner.

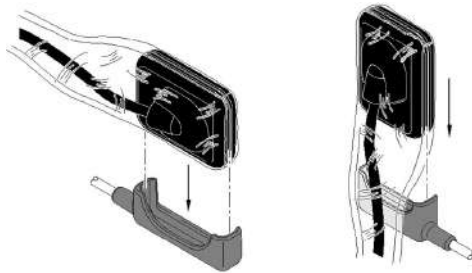

11. Position the RVG sensor in the mouth of the patient depending on the region of interest.

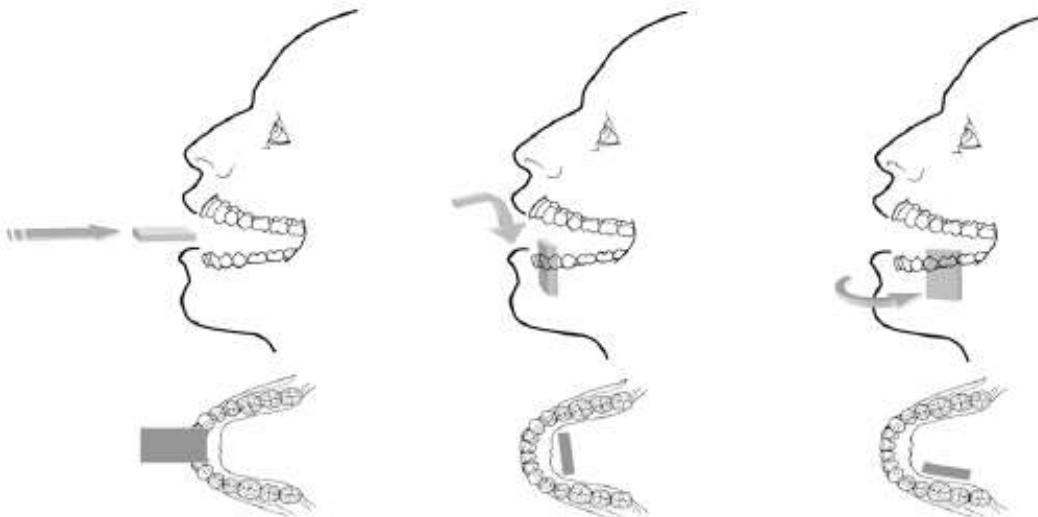

IMPORTANT: Always insert the RVG sensor holding it horizontally for the comfort of the patient.

12. Move the X-ray source tube head to the patient and align it with the tooth of the patient and the RVG sensor.



IMPORTANT: Make sure that the tube head is not shaking.

13. Select the X-ray exposure time according to the region of interest and the patient type (see [FMS Images X-ray Exposure Times](#)).

FMS Images X-ray Exposure Times

Follow the user instructions of your X-ray source. The following tables provide guidelines for exposure times for an X-ray source at 70 kV and 7 mA. Add your values for the exposure time in seconds in the column on the right. If your time values are different from the suggested time values, adapt your time values until you find the best setting for your diagnostic.

Table 3 ADULT exposure times

Acquisition Mode	Suggested Exposure Time in Seconds	Your Exposure Time in Seconds
Upper incisor/canine	0.18	
Upper premolar	0.24	
Upper molar	Up to 0.40	
Lower incisor/canine	0.12	
Lower premolar	0.18	
Lower molar	0.24	

Table 4 CHILD exposure times

Acquisition Mode	Suggested Exposure Time in Seconds	Your Exposure Time in Seconds
Upper incisor/canine	0.11	
Upper premolar	0.15	
Upper molar	0.24	
Lower incisor/canine	0.075	
Lower premolar	0.11	
Lower molar	0.15	



IMPORTANT: These are suggested exposure times and need to be adjusted for your specific X-ray source. For dark images, reduce the exposure time and for grainy images, increase the exposure time.

Acquiring FMS Images Using RVG Connect

To acquire FMS images using RVG Connect, follow these steps:

1. Tell the patient to remain still.
2. Position yourself either two meters behind the X-ray source or outside the door.



IMPORTANT: Make sure you can keep visual contact with the patient during the X-ray.

3. Make sure that the  icon is displayed on the RVG Connect unit.

Alternatively, make sure that  is displayed in the RVG FMS Acquisition interface indicating that the RVG sensor is connected to the workstation and is ready for acquisition. The selected frame for the image is highlighted in green.

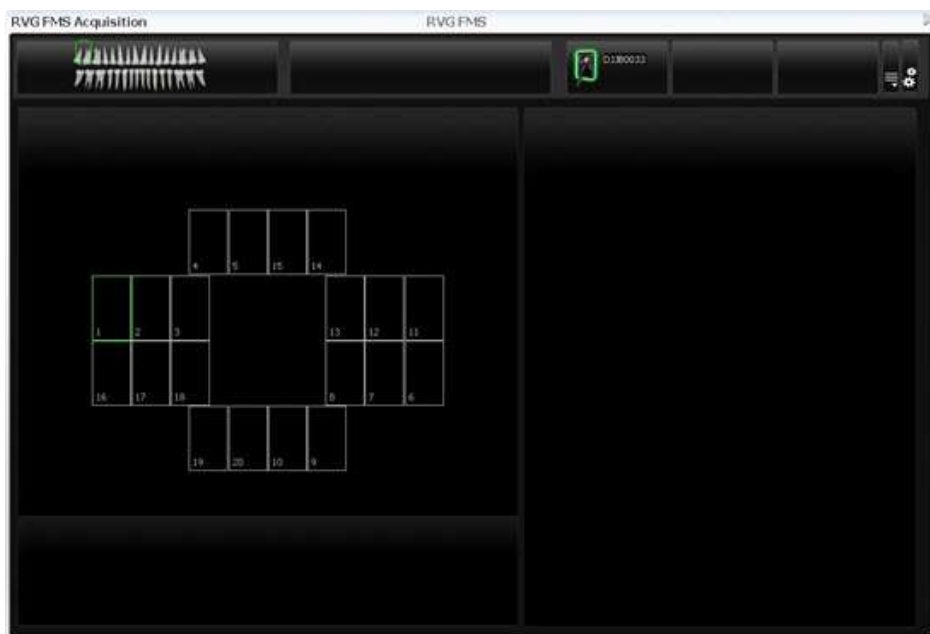

4. Trigger the X-ray with the remote control of the X-ray source.

The screen on the RVG Connect unit indicates the transfer of the image to the workstation.



- The image is displayed in the preview screen of the RVG FMS Acquisition interface.
 - The next frame is automatically highlighted in green, ready for the next acquisition.
5. Continue acquiring images until the whole FMS template is completed.
 6. Check the image and if the quality is:
 1. Not satisfactory, for example, if the exposure quality indicator is red, retake the X-ray (see [Retaking FMS Images with RVG 142, RVG 5200 and RVG 6200](#)).
 2. Satisfactory, remove the X-ray source tube head.

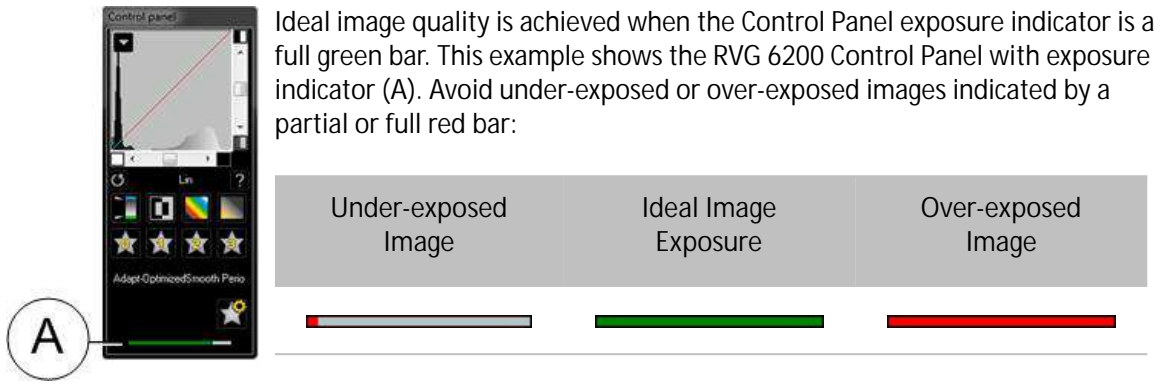

7. Remove the RVG sensor from the mouth of the patient.
8. Remove the hygienic sensor protection and throw it away.



IMPORTANT: Do NOT pull the RVG sensor by its cable when you remove the hygienic protection.

9. Clean and disinfect the RVG sensor after each patient (see the **RVG 142, RVG 5200 and RVG 6200 Safety, Regulatory, and Technical Specifications User Guide (SM847)**).
10. Use the CS Adapt Library software to manage the brightness/contrast filters.

In CS Imaging Software, you can use the CS Adapt Library software to manage the brightness/contrast filters as follows:

- Create custom filters by copying and editing existing factory preset filters.
- Use the Favorite function to select which filters are displayed in the Control Panel.
- Use the Acquisition Default function to automatically apply the selected filter at acquisition time.
- Import or export filter libraries.

Retaking FMS Images with RVG 142, RVG 5200 and RVG 6200

If you need to retake images, the sensor must be active.

To retake images, follow these steps:

1. Click to select the FMS frame you want to check.

A frame that already contains an image is highlighted in blue (D), and the image is displayed in the preview screen (B).

2. Check the image quality in the preview screen (B).

3. If you decide to retake the image, make sure the sensor is active (see (A) in [Acquiring FMS Images Using RVG 142, RVG 5200 & RVG 6200](#)).

4. Reposition the sensor and use the trigger to retake the image.

The new image is displayed in the selected frame (D), and a blue dot is displayed in the frame to show that it contains retake images.

The FMS retake image gallery (C) is displayed and only displays images acquired for the selected frame (D).



The retake images are automatically saved unless you want to select and delete them.

If required, select an image and adjust brightness  or contrast . Click  to reset your adjustments. These controls are displayed when you move your mouse over the image preview frame (B). Image brightness and contrast adjustments are automatically saved.





Note: By retaking images before the FMS acquisition has completed, you will interrupt the automatic acquisition sequence. To restart the automatic acquisition, click the next empty frame in the acquisition sequence.

5. If you want to set your image adjustments to default, click (A).

The CS Adapt Library window appears:



6. Click  and set your default adjustments. Click Save and Exit.
7. When the FMS acquisition is complete, click  to exit the RVG FMS Acquisition interface.
The FMS template with the acquired images and the applied image enhancements are saved and displayed in the Imaging Window.
The retake images are also saved in the Imaging Window but not as a part of the FMS template.
8. Remove the X-ray source tube head.
9. Remove the RVG sensor from the mouth of the patient.
10. Remove the hygienic sensor protection and throw it away.







IMPORTANT: Do NOT pull the RVG sensor by its cable when you remove the hygienic protection.

11. Clean and disinfect the RVG sensor after each patient (see the **RVG 142, RVG 5200 and RVG 6200 Safety, Regulatory and Technical Specifications User Guide (SM847)**).

Troubleshooting



IMPORTANT: If a malfunction persists or more serious conditions occur, contact your representative.

Malfunction	Possible Cause and Action
After triggering the X-rays, no image is displayed.	<ul style="list-style-type: none"> • Make sure that  is displayed in the Dental Imaging Software toolbar indicating that an RVG sensor is connected to the workstation and is ready for acquisition. • Make sure that  is displayed in the RVG FMS Acquisition interface indicating that an RVG sensor is connected to the workstation and is ready for acquisition. • Make sure that  is displayed on the screen of the RVG Connect unit indicating that an RVG sensor is connected to the workstation and is ready for acquisition. • Make sure the RVG sensor is correctly aligned with the X-ray source. • Make sure the settings of the X-ray source are correct. • Make sure that the RVG sensor is connected to a USB 2.0 port that is connected directly to the motherboard (generally located on the back of the workstation).
The image is pale and grainy.	<ul style="list-style-type: none"> • The exposure time is too short; increase it (see Single Image X-ray Exposure Times). • The X-ray source is too far from the patient with respect to the selected dose. • Check the contrast and brightness settings of the monitor and ensure there are no reflections on the screen. • The X-ray source voltage is too low; have the X-ray source checked.
The image is too dark.	<ul style="list-style-type: none"> • The exposure time is too high; lower it. • Check the monitor settings (contrast and brightness) and ensure there are no reflections on the screen.
The image is blurred.	<ul style="list-style-type: none"> • Patient moved during exposure. • X-ray source head was not stable. • Use an image filter to enhance the contrast.
The image is white.	<ul style="list-style-type: none"> • X-ray dose is insufficient. • Ensure the X-ray source is producing X-rays; have it checked by a certified technician.
RVG connection status is  .	<p>When an RVG sensor is connected to the workstation, an RVG icon is displayed in CS Imaging Software (see Imaging Software Overview). the color of the icon shows the connection status.</p> <p>When the icon is red, an error has occurred and an error message will be displayed in a popup window.</p>

Contact Information

Manufacturer's Address



Carestream Dental LLC
3625 Cumberland Boulevard, Suite 700
Atlanta, GA USA 30339

Factory

TROPHY
4, rue F. Pelloutier, Croissy-Beaubourg
77435 Marne-la-Vallée Cedex 2, France

Authorized Representatives

Authorized Representative in the European Community



TROPHY
4, rue F. Pelloutier, Croissy-Beaubourg
77435 Marne-la-Vallée Cedex 2, France

Authorized Representative in Brazil

CARESTREAM DENTAL BRASIL EIRELI
Rua Romualdo Davoli, 65
1º Andar, Sala 01 - São José dos Campos
São Paulo - Brazil
Cep (Zip Code): 12238-577

UK Responsible Person

Carestream Dental Ltd
Samantha Bush
Wiltron House, Rutherford Close Stevenage, Hertfordshire
SG1 2EF
England, United Kingdom

List of Importers for European Union According to MDR 2017/745

Carestream Dental France SAS
4 rue F. Pelloutier, Croissy-Beaubourg,
77435 Marne-la-Vallée Cedex 2, France
Carestream Dental Germany GmbH

Hedelfinger Str. 60
70327 Stuttgart, Germany
Carestream Dental Spain
S.L.U. Paseo de la Castellana, 79
Madrid 28046, España
Carestream Dental Italy S.r.l.
Via Mario Idiojmi 3/3,
Assago 20090 (MI), Italia