

# EzSensor **HD**

## Installation & User Manual

(IOS-U20VF, IOS-U15VF, IOS-U10VF,  
IOS-U20IF, IOS-U15IF, IOS-U10IF)

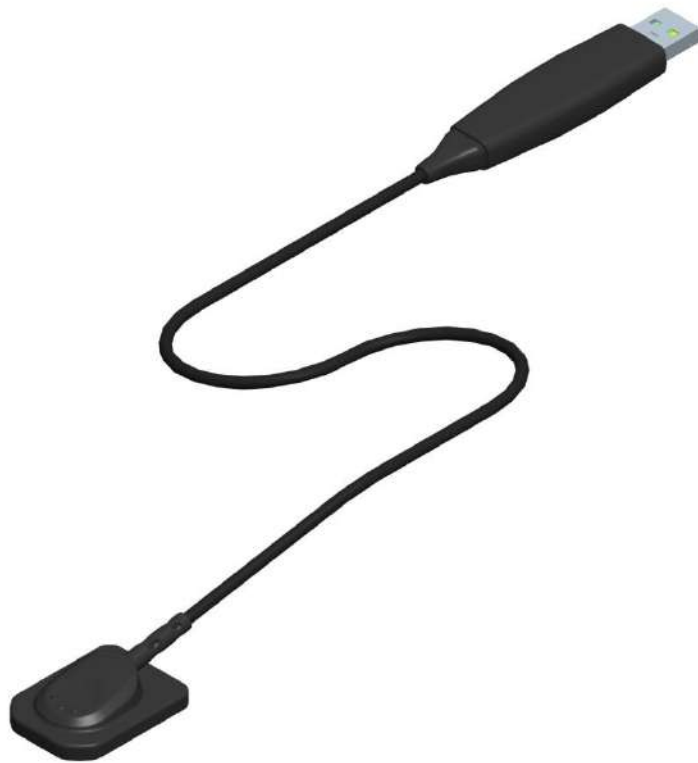

# Contents

<b>CHAPTER 1 INTRODUCTION .....</b>	<b>1</b>
1.1 Notice.....	1
1.2 Conventions and Symbols.....	1
1.3 Safety Instructions .....	3
1.4 Disposing of the Product .....	5
<b>CHAPTER 2 SYSTEM OVERVIEW .....</b>	<b>6</b>
2.1 System Description .....	6
2.2 Product Components .....	8
<b>CHAPTER 3 INSTALLATION .....</b>	<b>9</b>
3.1 PC Specifications .....	9
3.2 Installation of Software Driver .....	10
3.2.1 EzSensor HD( <i>IOS-U20VF, IOS-U15VF, IOS-U10VF</i> )Driver Setup .....	10
3.2.2 Cable connection & Driver Installation.....	12
3.3 Installation of the <i>EzSensor HD</i> Holder .....	14
<b>CHAPTER 4 IMAGE ACQUISITION BY USING <i>EASYDENT</i>.....</b>	<b>15</b>
4.1 Installation of EasyDent .....	15
4.2 Image Acquisition Overview .....	20
4.3 Running the EasyDent.....	21
4.3.1 Patient Registration and Device Selection.....	21
4.3.2 Single Shot .....	23
4.3.3 Multi Shot.....	27
4.3.4 Sequence Shot .....	31
<b>CHAPTER 5 IMAGE ACQUISITION BY USING <i>EZDENT-I</i>.....</b>	<b>34</b>
5.1 Installation EzDent- i.....	34
5.2 For Regular Users: Activating License With A USB Dongle Key. ....	40
5.3 For Demo Users, Activating License With A License Key .....	43
5.4 Consult DB License Activation.....	45
5.5 Preparing for Image Acquisition .....	48
5.6 Running the EzDent- i.....	49
5.6.1 Patient Registration .....	49
5.6.2 Acquiring Image .....	50

5.6.3 Image View.....	54
-----------------------	----

## **CHAPTER 6 MAINTENANCE .....55**

<b>6.1 Visual Inspection .....</b>	<b>55</b>
<b>6.2 Periodic Maintenance.....</b>	<b>55</b>
6.2.1 Test List .....	56
6.2.2 Connection .....	56
6.2.3 Cable .....	57
6.2.4 Resolution.....	57
<b>6.3 Care and Cleaning .....</b>	<b>58</b>
<b>6.4 Precautions .....</b>	<b>58</b>
<b>6.5 Product complaint .....</b>	<b>59</b>

## **APPENDIX 60**

<b>A.1 X-ray Exposure Guide .....</b>	<b>60</b>
<b>A.2 Error Message.....</b>	<b>62</b>
<b>A.3 Troubleshooting .....</b>	<b>64</b>
<b>A.4 Electromagnetic Compatibility Information.....</b>	<b>65</b>

# Chapter 1 Introduction

## 1.1 Notice

For the improvement of Product performance, supplementation, and the follow-up of information, the contents of this manual are subject to change without prior notice.

Please note that our company bears no responsibility for accidental damage nor will we be obligated to provide warranty service for any damage to equipment due to user error. Please follow the instructions in this manual closely. Become familiar with the safety precautions and usage procedures for this Product. Note that the Product may differ slightly from the contents of this manual, depending on individual Product specifications.

## 1.2 Conventions and Symbols

### 1. Convention

The following symbols are used throughout this manual to provide instructions on the effective use of this Product.



**Indicates useful information and tips on how to use our software and Products.**



CAUTION

**Indicates important instructions. If not observed, malfunction or damage to the Product or other property may occur.**



WARNING

**Indicates warnings and safety instructions. If not adhered to, there is a serious risk of injury to the patient and/or the operator.**

---









---

**For U.S.A. users: United State federal law restricts this device to use by or on the order of physician.**

**For other countries users: This device to use by or on the order of a licensed person under the related laws in each country.**

---

2. Symbols Descriptions

Item	Symbol	Description
1		Type B applied part
2		Refer to instruction manual/ booklet
3	<b>CE0120</b>	Conforms to CE MDD 93/42/EEC (European Communities) concerning medical devices
4		Waste Electrical and Electronic Equipment
5		Manufacturer
6		Date of manufacture
7	<b>SN</b>	Serial number
8	<b>EC REP</b>	Authorized representative in the European Community
9		Handling procedures for Electro-Static Discharge (ESD).
10		Handle with care
11		Fragile, handle with care
12		This way up

### 1.3 Safety Instructions

#### Indications for Use

***EzSensor HD*, an Intra-oral Imaging device, is intended to collect dental x-ray photons and convert them into electronic impulses that may be stored, viewed, and manipulated for diagnostic use by dentists.**



CAUTION

Before each usage, check the outer surface of the ***EzSensor HD*** for any signs of physical damage or defect. The surface of the ***EzSensor HD*** should have a smooth finish, with no evidence of chipping or damage. Otherwise, contact your local Product distributor for further instructions on how to proceed.



CAUTION

To ensure the correct usage of the ***EzSensor HD*** device in a clinical environment, for which the intended purposes correspond to its design and application, only dentists or their designated operators are authorized to operate this Product



CAUTION

Modifications and/or additions to the device must be conducted exclusively by MANUFACTURER or by parties expressly authorized to do so by MANUFACTURER. Any modifications or additions must always comply with the standards and generally recognized rules of good workmanship.

It is the user's responsibility to ensure compliance with all local safety regulations in effect in the jurisdiction of installation.

---

**Electrical safety**

---



The covers of the Product may be removed only by qualified and authorized technical personnel.



This Product can only be used in rooms or areas that comply with all laws and regulations applicable to electrical safety on medical premises, such as IEC standards for the use of an additional ground terminal for equipotential connections. This Product must always be disconnected from the power supply before cleaning or disinfecting.



This Product should be connected with a device which is complied with IEC 60601-1. Water and other liquids must be kept at a distance to avoid penetration of the Product. Liquids may cause corrosion or the Product to short circuit. No protection is offered against liquid penetration.

---

**Explosion safety**

---



This Product is not recommended for use in the presence of flammable gases or vapours. Some disinfectants evaporate and form explosive or flammable mixtures. If disinfectants of this kind are used, it is important to let the vapours disperse before using the Product again.

For the improvement of Product performance, supplementation, and follow-up of information, the contents of this manual are subject to change without prior notice.

---

**X-ray protection**

---



The rules of dental radiography apply to digital X-ray systems. Please continue to use protection for your patients. As a clinician, clear the immediate area when exposing the sensor.

---

## 1.4 Disposing of the Product

### 1. WEEE information according to directive 2002/96/EC

(Waste Electrical and Electronic Equipment)



The crossed-out wheeled bin symbol, that is present on the Product, means that within the European Union the product must be taken to separate collection at the product end-of life. Therefore, at the end of the life-cycle of the Product, the user



should deliver the device to the proper collection facilities of the Electric and

Electronic Equipments. Alternatively, the user can return the Product to the seller, on a one-to-one basis, as long as he or she is buying a new one of equivalent type and that fulfils the same functions as the old one.

Disposing of the Product separately avoids possible negative consequences for the environment and health deriving from inappropriate disposal and enables the constituent materials to be recovered to obtain significant savings in energy and resources.

Who disposes any Electric and Electronic Equipment, reporting the above symbol, as unsorted municipal waste, instead of collecting it separately, incurs the administrative sanctions in accordance with law.

### 2. Label Location

The label can be found on the **EzSensor HD** device.



## Chapter 2 SYSTEM OVERVIEW

### 2.1 System Description

This manual covers the installation and operating procedures of the **EzSensor HD( IOS-U20VF, IOS-U15VF, IOS-U10VF, IOS-U20IF, IOS-U15IF, IOS-U10IF)** “collectively or individually referred to as **EzSensor HD or Product**”.

Unless otherwise specified, all the information contained in this manual is applicable equally to all **EzSensor HD** types.

<Table 1. Specifications >

Parameter	Description
Detector Structure	CMOS Photodiode Array
Dimensions (W x L x T)	Size 1.0: 1.44 x 1.00 x 0.19 inch (36.8 x 25.4 x 4.8 mm) Size 1.5: 1.55 x 1.15 x 0.19 inch (39.5 x 29.2 x 4.8mm) Size 2.0: 1.69 x 1.28 x 0.19 inch (42.9 x 31.3 x 4.8 mm)
Pixel Pitch	High Resolution mode : 0.0148 mm Normal Resolution mode : 0.0296 mm
Active Pixel Array	Size 1.0: 1.18 x 0.79 inch (30.01 x 20.01 mm) 2028 x 1352 pixels @ High Resolution mode 1014 x 676 pixels @ Normal Resolution mode Size 1.5: 1.30 x 0.94 inch (33.00 x 23.98 mm) 2230 x 1620 pixels @ High Resolution mode 1115 x 810 pixels @ Normal Resolution mode Size 2.0: 1.42 x 1.02 inch (35.99 x 25.99 mm) 2432 x 1756 pixels @ High Resolution mode 1216 x 878 pixels @ Normal Resolution mode
USB Cable length between Controller and PC	2.7 m
Electrical rating	DC 5V, 500mA

Operation mode	Global shutter
Ambient Temperature	10°C to 30°C (Usage) -20°C to 60°C (Transportation and Storage)
Relative Humidity	30% to 95% (Usage) 10% to 95% (Transportation and Storage)
Air Pressure	700 to 1060 hPa
EU classification	Medical Devices 93/42/EEC as a class IIa
Protection against shock	Type B applied part
Protection against matter/Water	IP68



CAUTION

The Product has to be installed, transported and stored in the permissible environmental conditions. Use the provided protective package for transporting or storage. Also, the Product should not operate in oxygen rich or explosive environments.

## 2.2 Product Components

The **EzSensor HD** device installer should check the following items listed in the table below before Product installation. If the serial numbers of the individual parts do not match, do not install the Product. Contact your local distributor or agent for support.

This Product should be connected with a device or product which is complied with IEC 60601-1.

<Table 2. **EzSensor HD** Product components>

No	Components	Remarks
1.	Sensor Module*	2.7m USB cable is all in one
2	Wrap* (Hygienic Sleeves)	
3.	Holder for Sensor	
4	Silicon cover*	
5.	S/W Installation CD(or USB)	<b>EasyDent</b> (or <b>EzDent-i</b> )
6.	Driver Installation CD	USB Device Driver
7.	<b>EzSensor HD</b> Manual	Document

\* Patient applied part (Inside Patient environment)

### Sensor Module:

Consists of a special CMOS sensor specifically designed for use in radiography and enclosed in a hermetically sealed ergonomic capsule. The sensitive surface of the sensor is covered with a thin layer of scintillating phosphorous, through which X-ray radiation is converted into light and then into an electric charge.



## Chapter 3      INSTALLATION

### 3.1      PC Specifications

#### 1. Recommended Server PC Specifications

- Workstation
- Operating System: Window 2000 server or higher
- RAM: 4GB or Higher
- HDD: 1TB or higher

#### 2. Recommended Client PC Specifications

- CPU: Core DUO CPU 1.8GHz or Higher
- Main Memory: 2GB of Higher
- Graphic Card : 512MB or Higher
- HDD: 2GB free space
- Display: 1280x1024x32bpp

#### 3. Operating System

- Window 34&64bit: XP(SP1), Vista, 7, 8, 8.1



***We cannot guarantee that Easydent (EzDent-i) will work properly with an unregistered copy of Microsoft Windows. Therefore, you should use a registered, genuine version of Microsoft Windows.***

---

---



***Turn off the Windows Firewall service for proper communication across the network for the installed database and file servers.***

---

---



***If you need to install additional software on your computer, please install only those that are internationally authorized. Take extra precaution when installing any Active-X controls.***

---

---

## 3.2 Installation of Software Driver



*To operate the intraoral sensor, you need to install the EzSensor HD Driver. This Product should be connected with the product or the device which is complied with IEC60601-1*

### 3.2.1 EzSensor HD( IOS-U20VF, IOS-U15VF, IOS-U10VF)Driver Setup

This step is necessary for the installation of **EzSensor HD**. Capturing software and Calibration data for the **EzSensor HD** will be installed and downloaded along with the Windows device driver. A Twain driver is also installed during this step.

#### Step 1

Insert the S/W Installation CD in the CD-ROM. Setup should start automatically.

If it does not, click **Start>Run** and type

**Homedirctory:\Console\setup.exe**

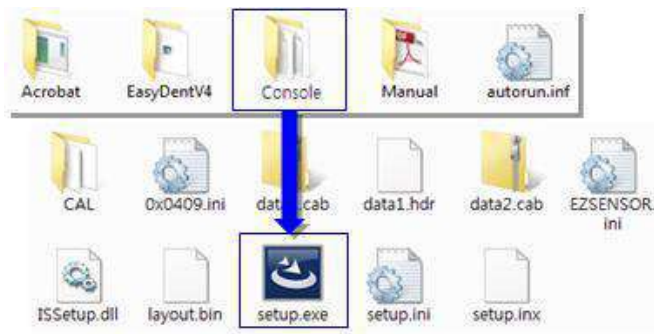

#### Step 2

The install program for 'IntraOral USB-Sensor Acquisition Software' will appear. Click the 'Next' button.

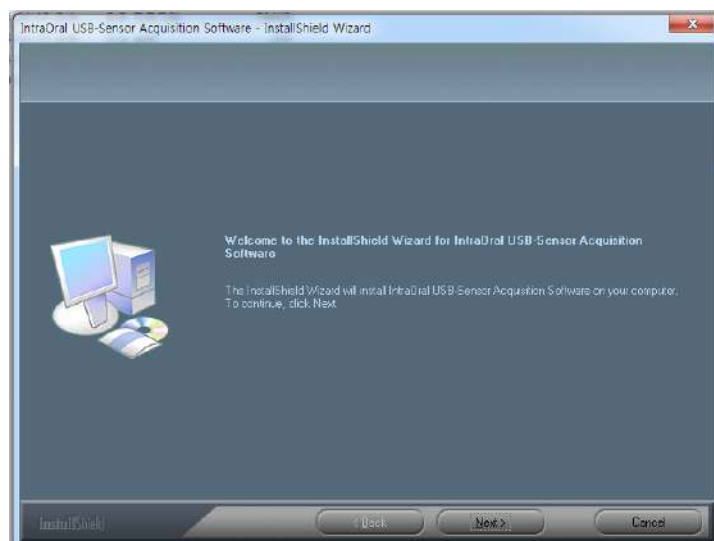

### Step 3

Check the **EzSensor HD** installation directory and then click the 'Next' button.

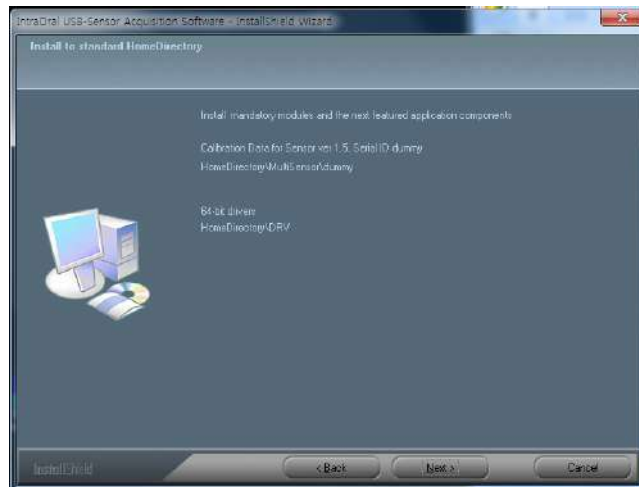

### Step 4

The Install shield Wizard will start configuring the installation parameters.

The Install-shield wizard will Copy the calibration files To your work-station (PC).

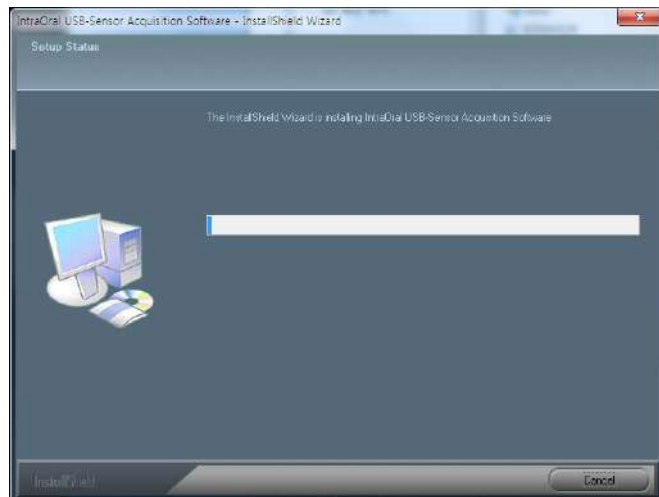

### Step 5

The Install-shield wizard will be done.

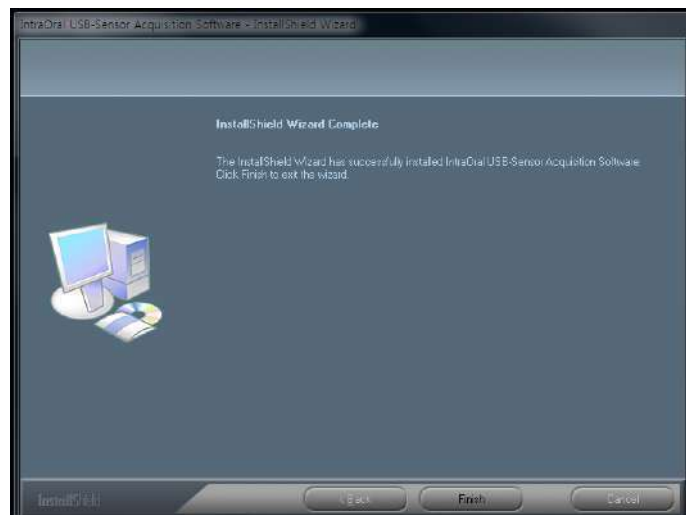

### 3.2.2 Cable connection & Driver Installation



*Do not connect the EzSensor HD and USB PC Interface cable to your computer until you have successfully installed the setup program.*



*Only connect the item that has been specified as part of the Medical Equipment System.*



#### Step 1

Connect the **EzSensor HD** USB Connector to the USB port on the PC directly.  
**Be sure to connect the USB port on backside for accurate operation.**

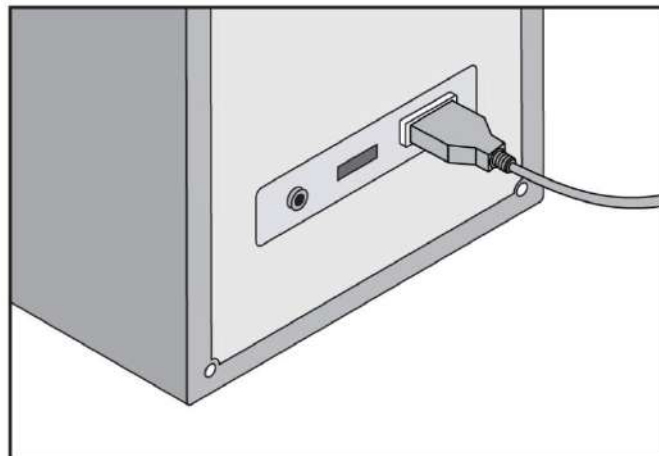

**Step 2**

Confirmation of Driver installation at the Device Manager.

**Method of Confirmation:**

Windows 7 : Control Panel → System and Security → System → Device Manager

Windows XP : Settings → Control Panel → System → Hardware → Device manager

Select 'VH EzSensor-N x.x', located under Imaging Devices. You should see the message, "This device is working properly".

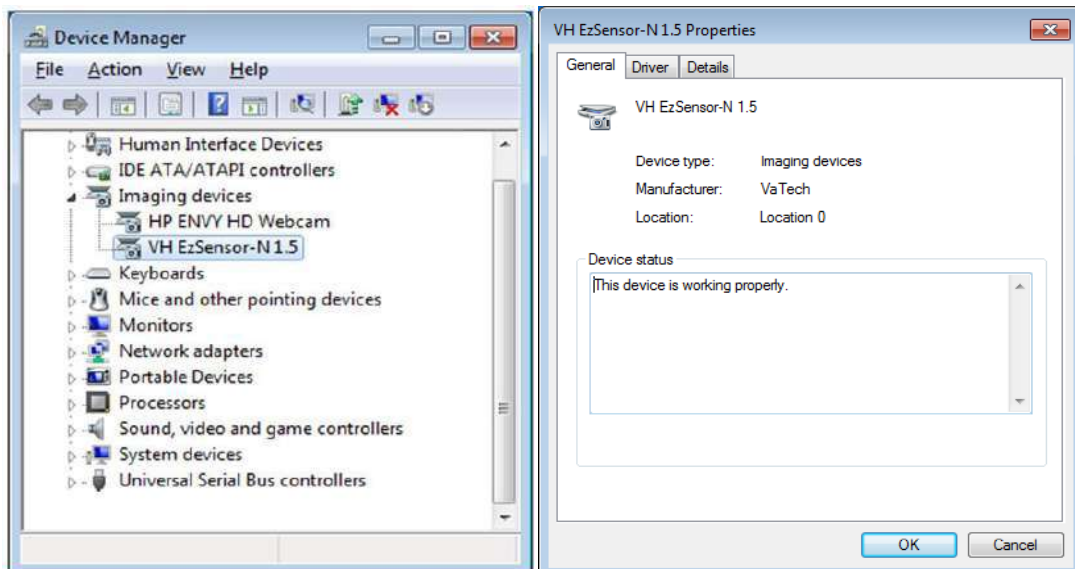

***EzSensor HD is supplied to the power and transports data via the USB port of the PC. Do not disconnect during usage.***



### 3.3 Installation of the *EzSensor HD* Holder

The *EzSensor HD* holder is used for mounting the *EzSensor HD* to the wall when not in use. When choosing where to install the *EzSensor HD*, locate an area that offers easy access and visibility during patient examinations.

Position the holder on a stable, flat surface. Using the holes at the back of the holder as guides, fasten the holder securely to the wall using two dry wall screws (included).

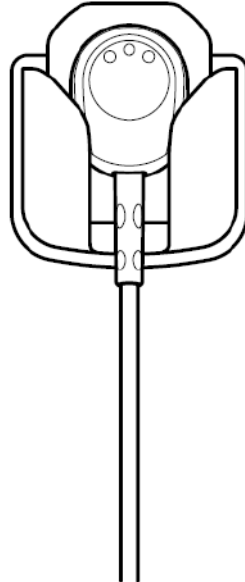
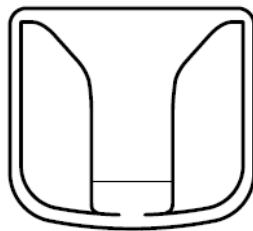

## Chapter 4 Image Acquisition by using *EasyDent*

### 4.1 Installation of EasyDent

In this step, *EasyDent* will be installed. Alternatively, software which supports the Twain interface can be used instead of *EasyDent*.

#### Step 1

Insert the S/W installation CD in the CD-ROM drive.

**Homedirectory:\EasyDent\setup.exe**

. Press 'Enter'.

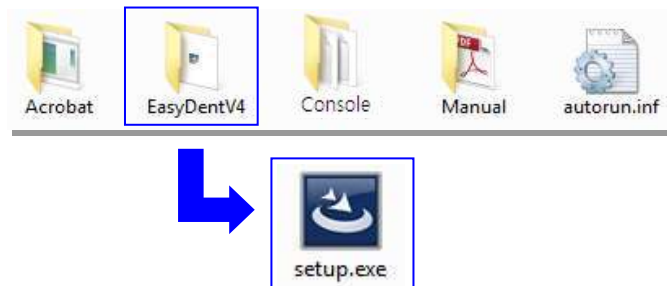

#### Step 2

Select the language you want to install and then click 'Next'.

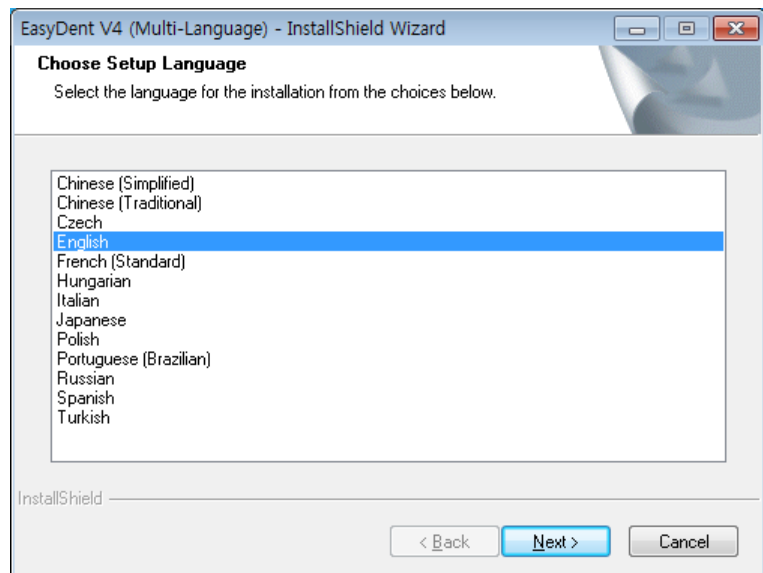

### Step 3

The 'EasyDentV4 Install Shield Wizard' will appear. Click the 'Next' button.

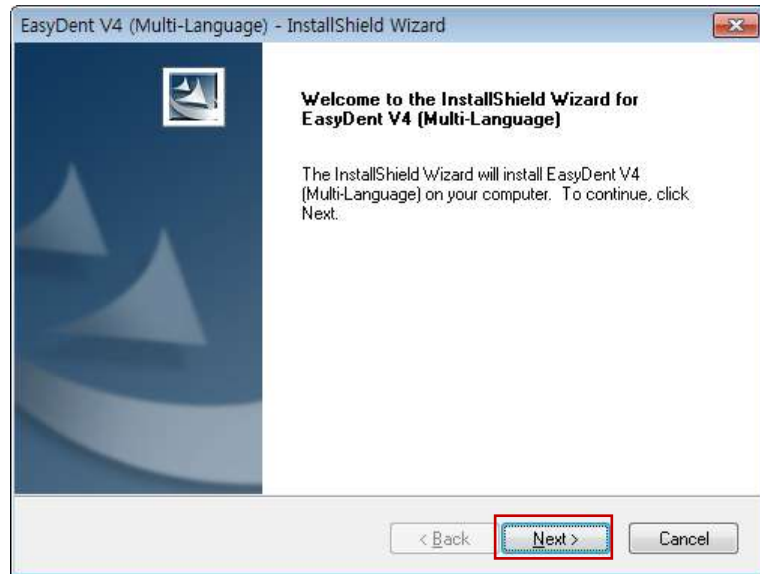

### Step 4

Select the setup type that best suits your needs. Click the 'Next' button.

-----  
**Basic** : Installs the basic version of EasyDent V4

**CD-Publishing** : Installs the basic version of EasyDent V4 along with CD-Publishing capabilities (optional)  
 -----



*For the EasyDent server, select all items.*

*For PC being used for viewer: Select only the items except for DB & File servers.*

*For the detailed installation, refer to the EasyDent installation manual.*

## Step 5

Select the features that you want to install. Click the 'Next' button.

**EasyDent Viewer** is the minimum requirement for **EzSensor HD** use.

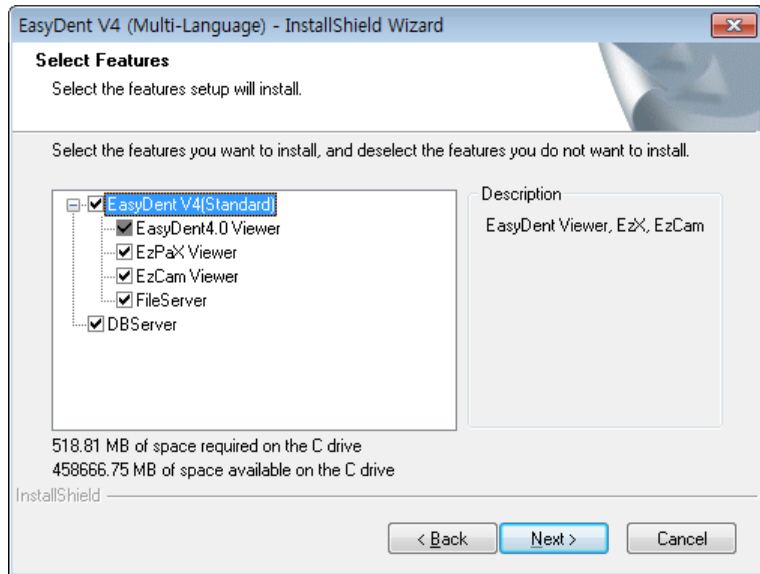

## Step 6

Now you are ready to install. If you would like to review any of your installation settings, click 'Back'. To proceed with the installation, click 'Install'. Click 'Cancel' to exit the wizard.

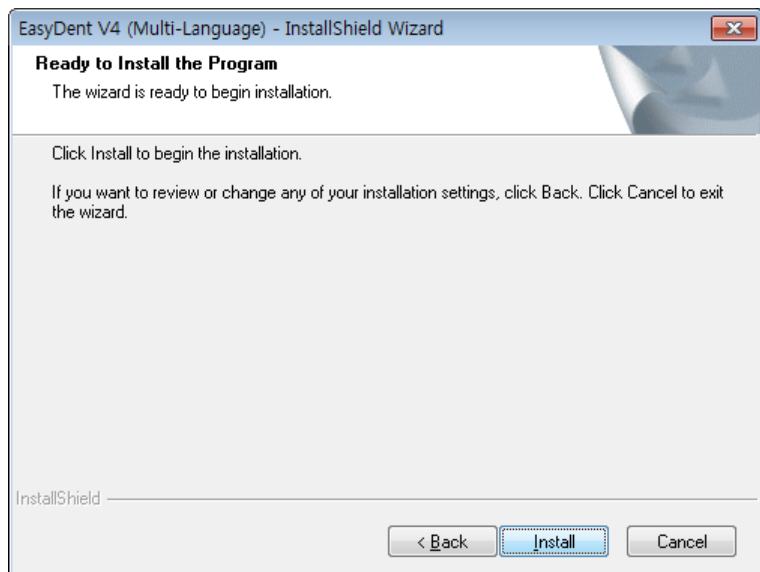

## Step 7

Installing *EasyDentV4*

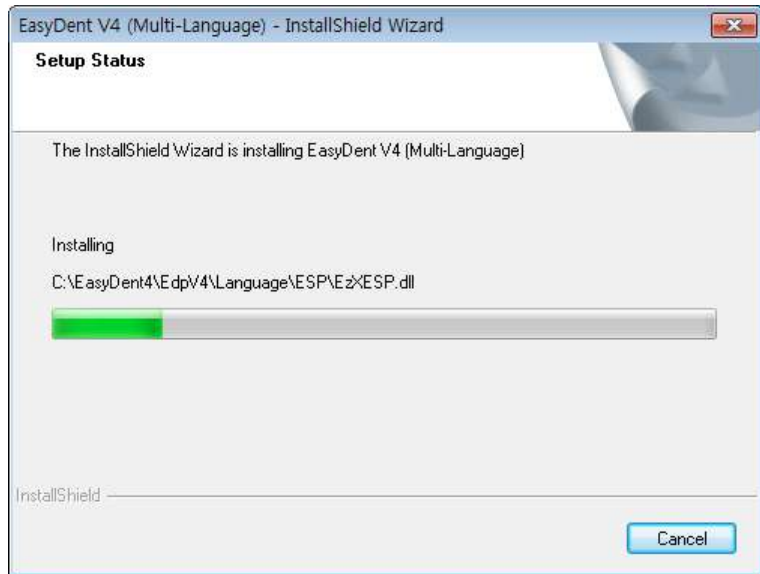

## Step 8

The program compatibility and Windows Firewall alarm messages are shown.

Click 'Run program' button on the program compatibility message.

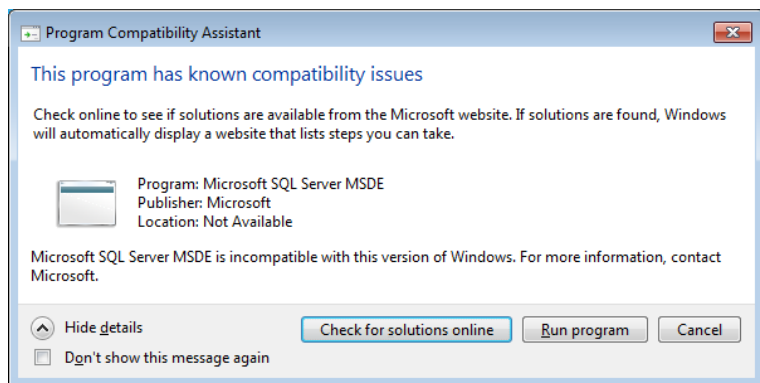

And click 'Allow access' button on the windows security message.



## Step 9

MSDE(Microsoft SQL server Desktop Engine) is installed automatically.  
Close the SQL Server Service Manager.

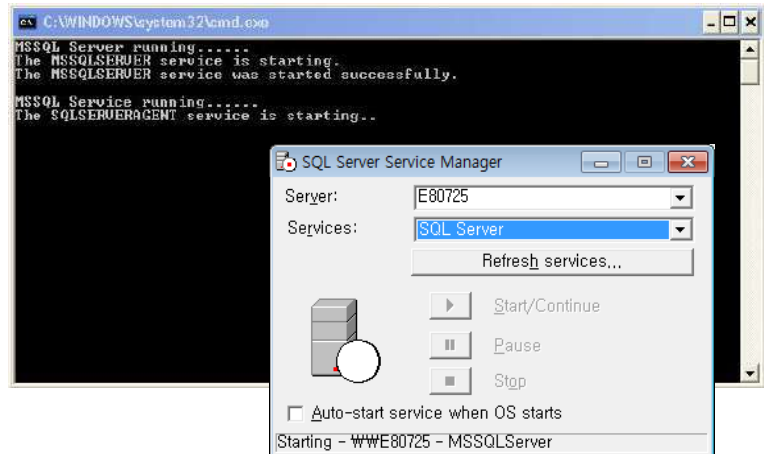

## Step 10

Select 'No, I will restart my computer later', and then click 'Finish'.

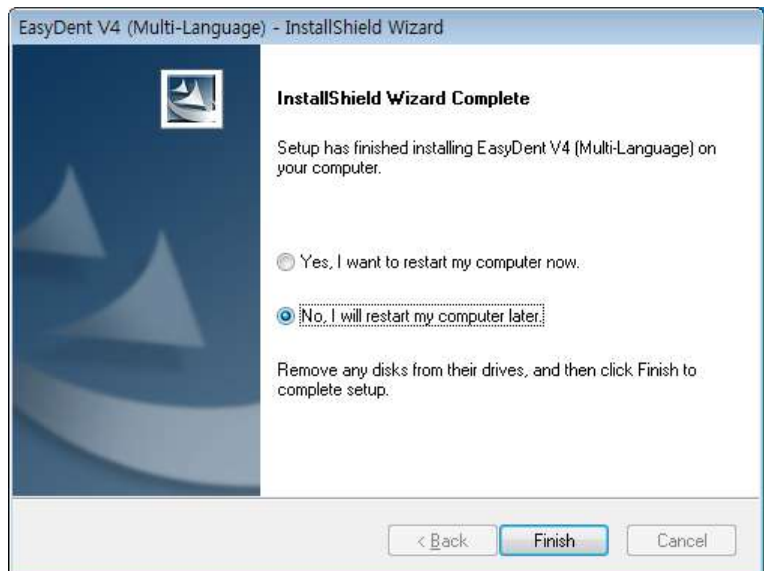

## 4.2 Image Acquisition Overview

- ① Turn on the computer.
- ② Run the EasyDent.
- ③ Configure the required X-ray parameters (exposure time, etc.) for the X-ray generator.
- ④ Before use the sensor, shooting the X-ray with putting the coin on flat receptor of the sensor is recommend as an operation test.
- ⑤ Position the **EzSensor HD(10S-U20IF, 10S-U15IF, 10S-U10IF)** at the appropriate area in the mouth. The flat receptor side of the sensor must face the X-ray source. Note that the receptor side is marked with a label for ease of recognition.  
The use of the sensor positioning aid is recommended to guarantee that the sensor is parallel to the tooth and is at the appropriate angle for exposure
- ⑥ The use of the parallel technique with a positioning system or device, if possible, is highly recommended.
- ⑦ After preparing the sensor for exposure, acquire an image by pressing the exposure button of your X-ray source.



Using the EzSensor HD  
with intraoral X-ray



Using the EzSensor HD  
with a Sensor positioning system(optional)



**Normal Resolution Mode**

*This mode is typical operating and general usage and somewhat shows lower resolution, but gets speed of data readout faster.*

### 4.3 Running the EasyDent

Shot functions are available after patient registration and device selection. Single shot, multi shot, sequence shot are used frequently. You must be fully aware of the explanations before capturing image.

#### 4.3.1 Patient Registration and Device Selection

##### Step 1

Turn on the PC.

Run EasyDent4 Viewer. Click the 'Patient (  )' button to register a new patient.

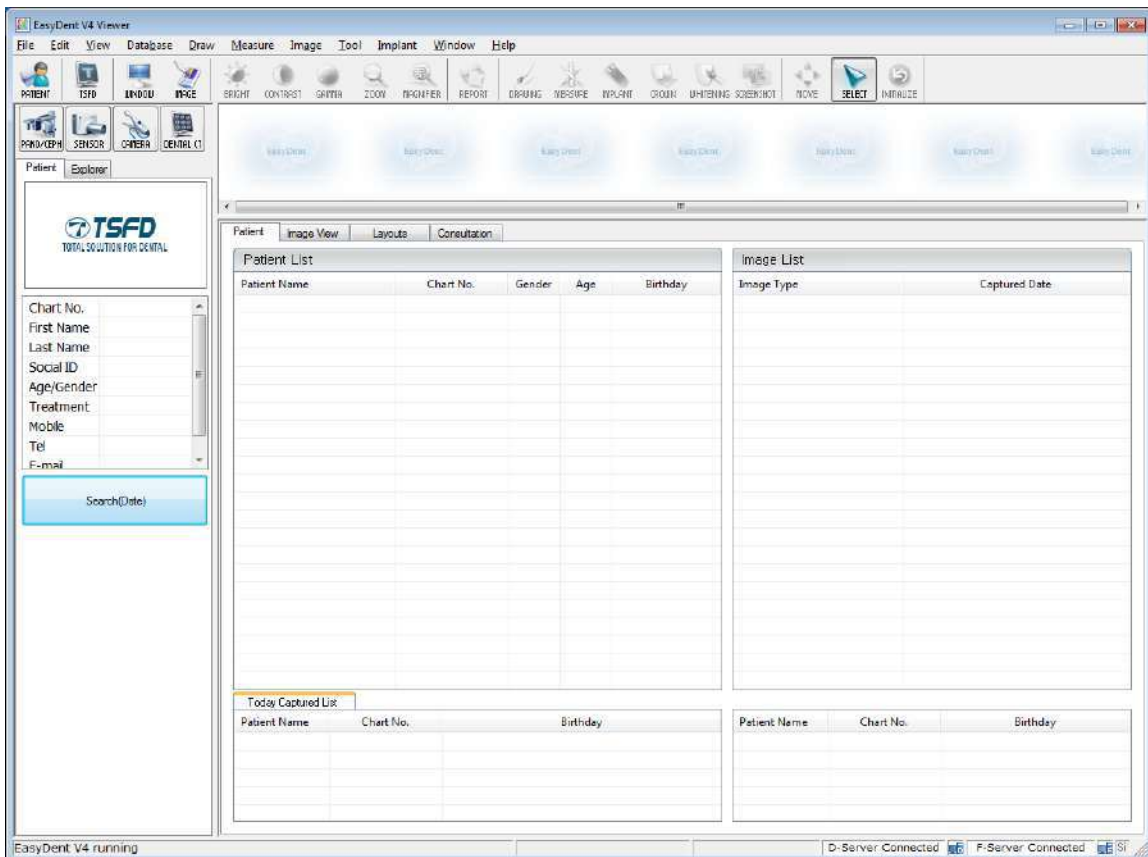



## Step 2

The new patient registration window will appear. You are asked to register the new patient and click “Add”.

## Step 3

Click ‘Help > Intra-Oral Sensor Setting > Select Device’ on the menu bar.

Select your capture device. At this time, you are asked to select the device and image quality.

The Productand image processing setting information is stored internally. Change these settings when using another sensor or changing the image processing option.

Level 4 is basic image processing option. As the level no. is higher, the effect of contrast and enhancement get increased.

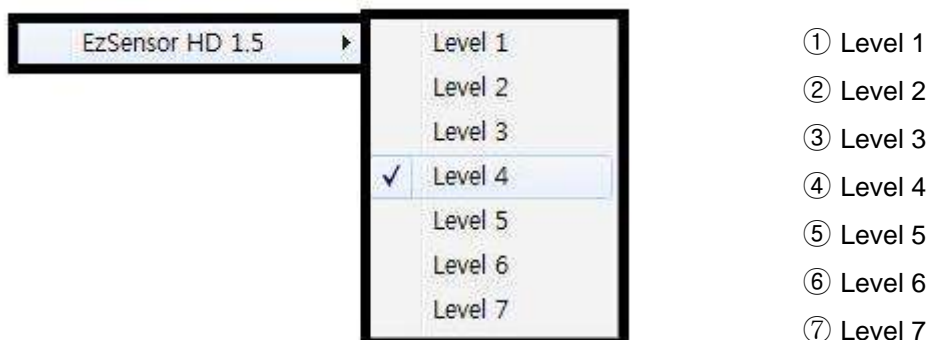

### 4.3.2 Single Shot

Capture a single image.

#### Step 1

Start EasyDent by clicking the EasyDent V4 Viewer on the desktop.

Search and enter the appropriate patient information.

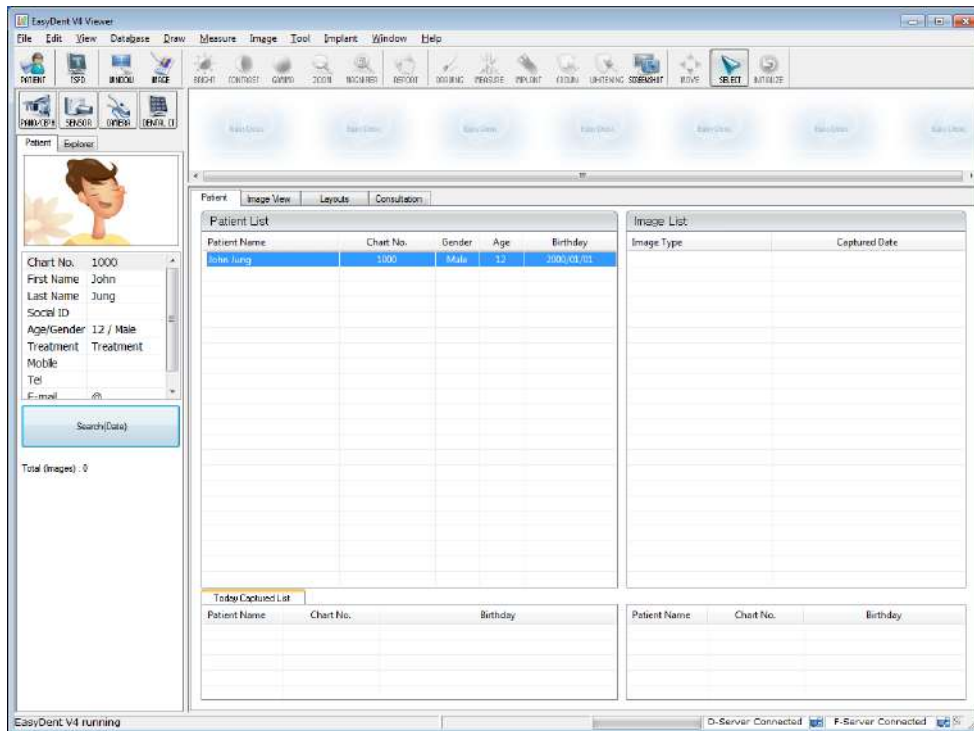

## Step 2

Click the 'Layouts' tab. Select your favorite layout from the Layout template list. The Layout Template can be customized. Please refer to the EasyDent manual.

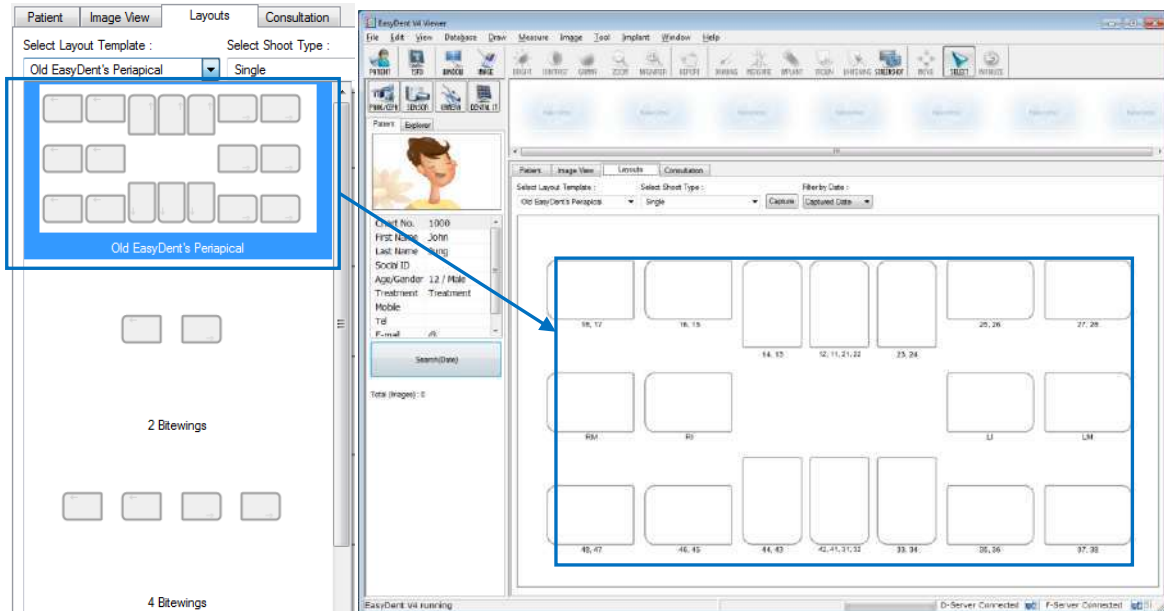

## Step 3

Select the 'Single' from the Shoot Type list.

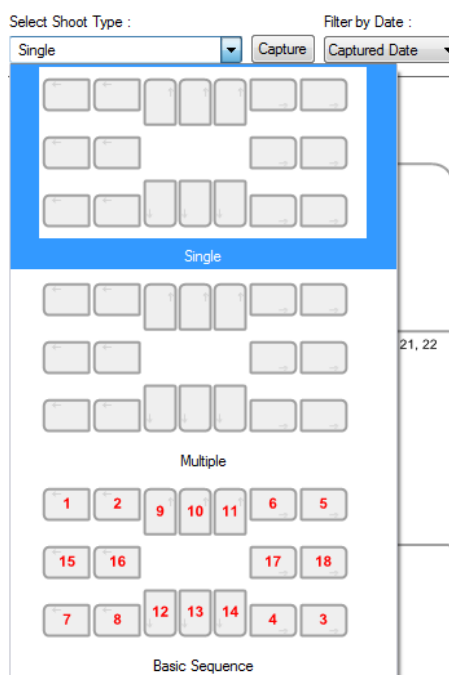

### Step 4

Select the tooth position to capture. The tooth box is selected in blue.

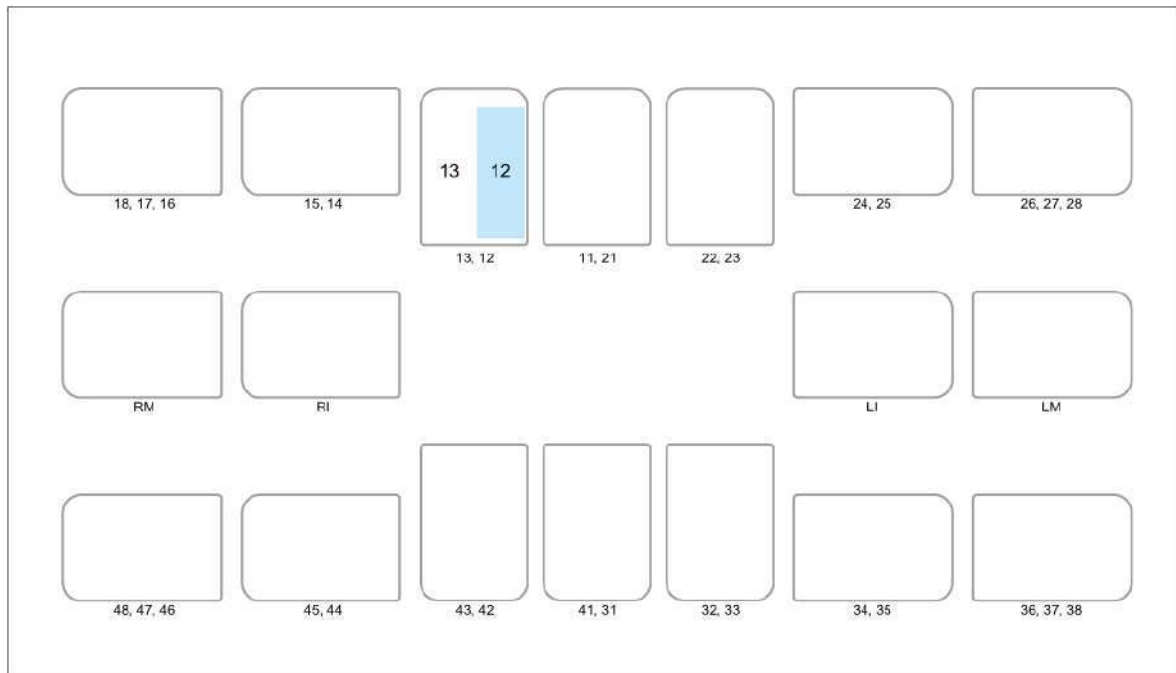

### Step 5

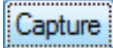
Click the 'SENSOR (  )' button or 'Capture (  )' button.

### Step 6

Position the sensor correctly.

## Step7

After checking the sensor is in the correct position, expose the X-ray after the “Please expose X-ray” message appears.

The message, “Optimizing Image... Please wait” appears while the image is being optimized. The image will appear after optimization is complete.

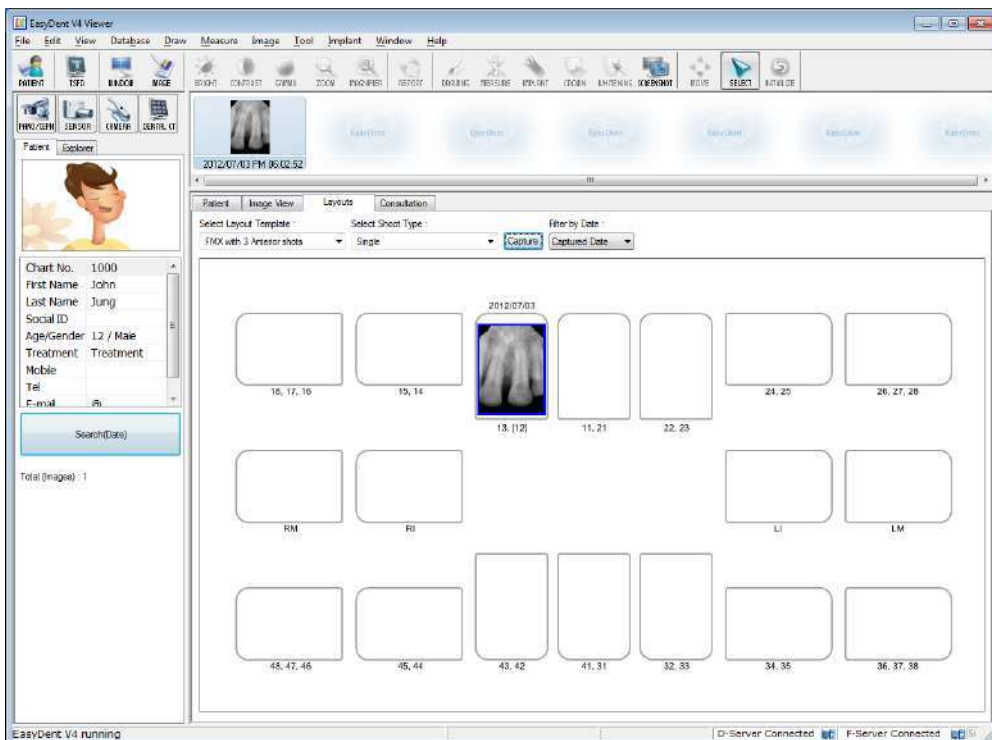
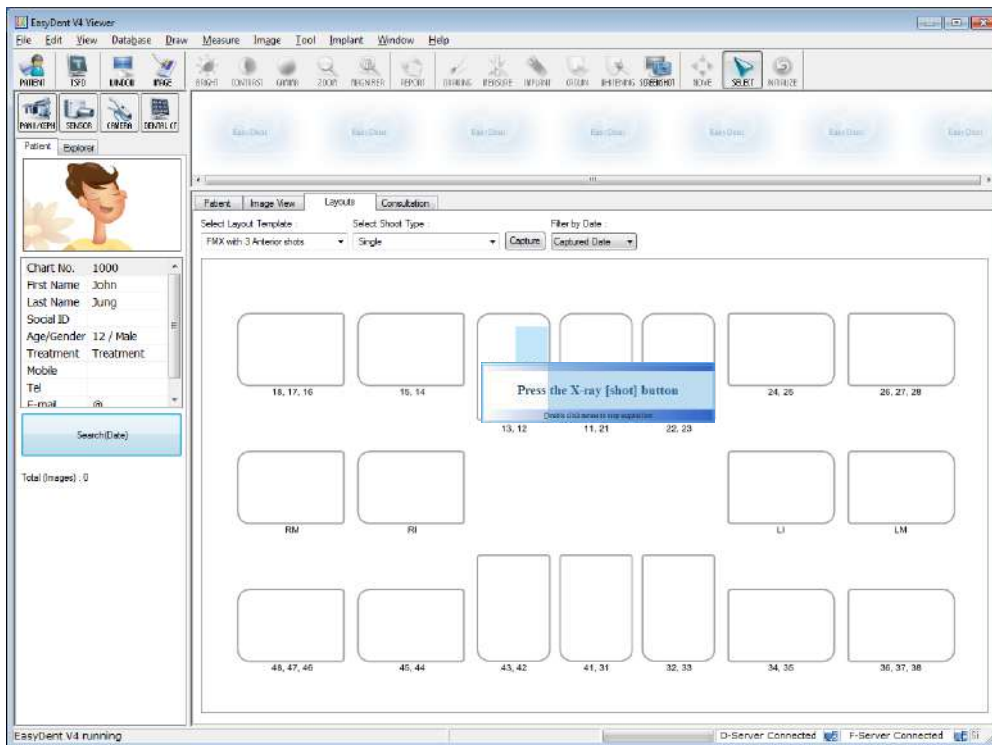

### 4.3.3 Multi Shot

You can capture multiple images continuously until you click stop. Click and drag the image to its appropriate position after stopping capture.

#### Step 1

---

Select the 'Multiple' from the Shoot Type list.

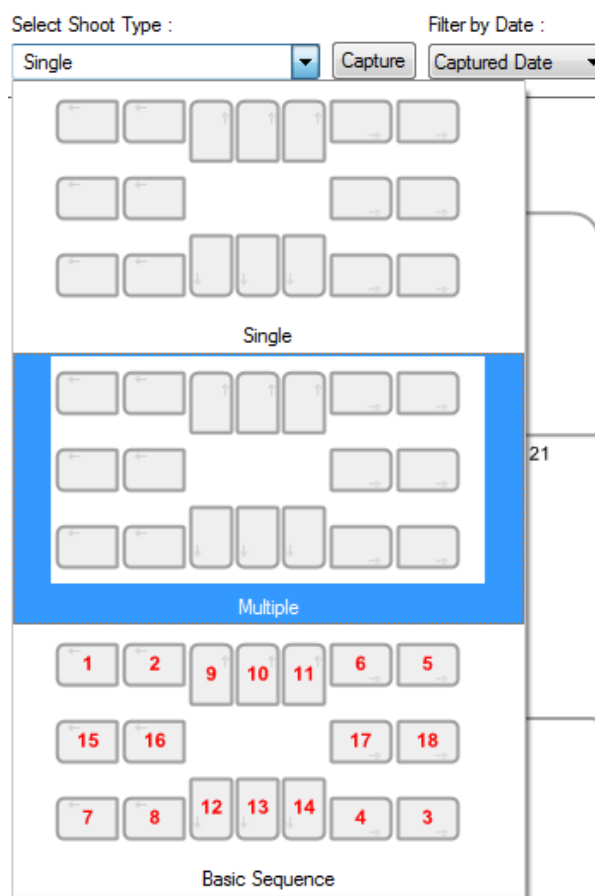

### Step 2

---

Select the tooth position to capture. A blue rectangle will be drawn on the tooth box.

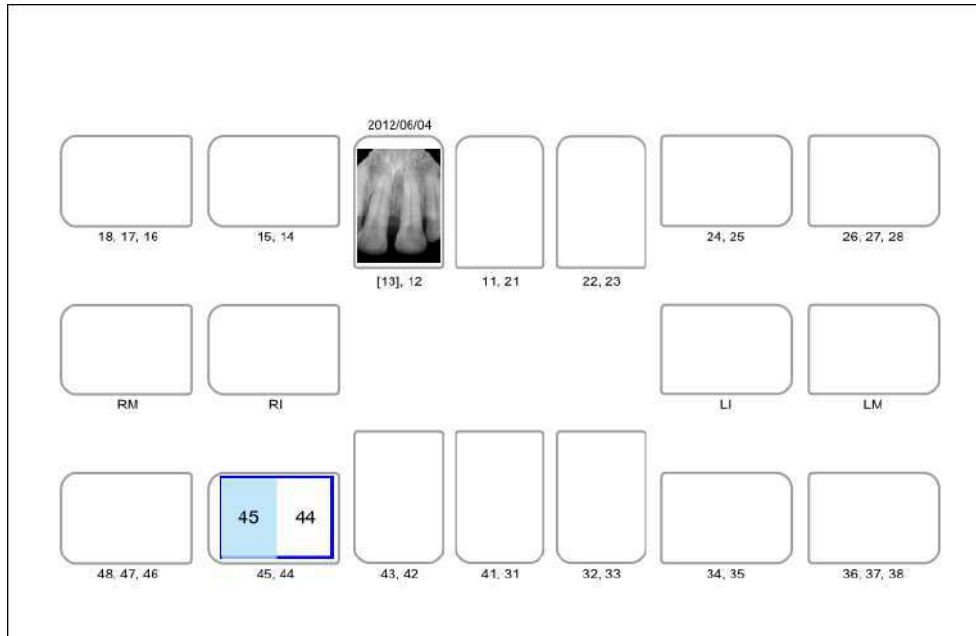

### Step 3

---

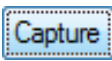
Click the 'SENSOR (  )' button or 'Capture (  )' button.

### Step 4

---

Position the sensor correctly.

## Step 5

Expose the X-ray after the “Please expose X-ray” message appears.

The message, “Optimizing Image... Please wait” appears while the image is being optimized.

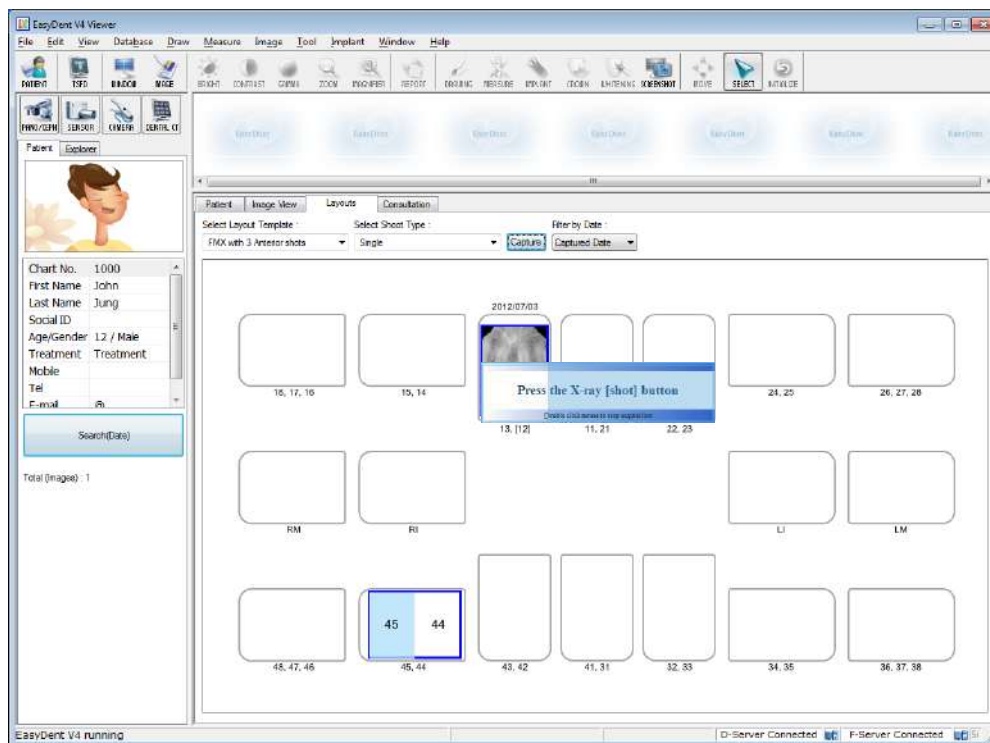



## Step 6

If you want to acquire more images, continue to expose the x-ray when the 'Press the X-ray (shot) button' message appears.

To finish, double click on the 'Press the X-ray (shot) button' message box. And then the image will appear after optimization is complete.

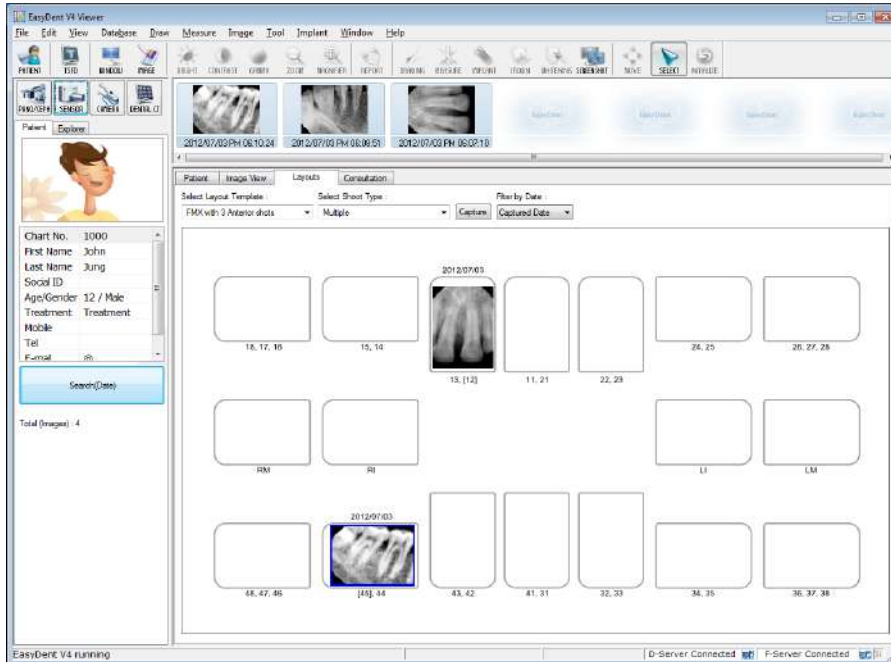

## Step 7

Click and drag the image to its appropriate position.

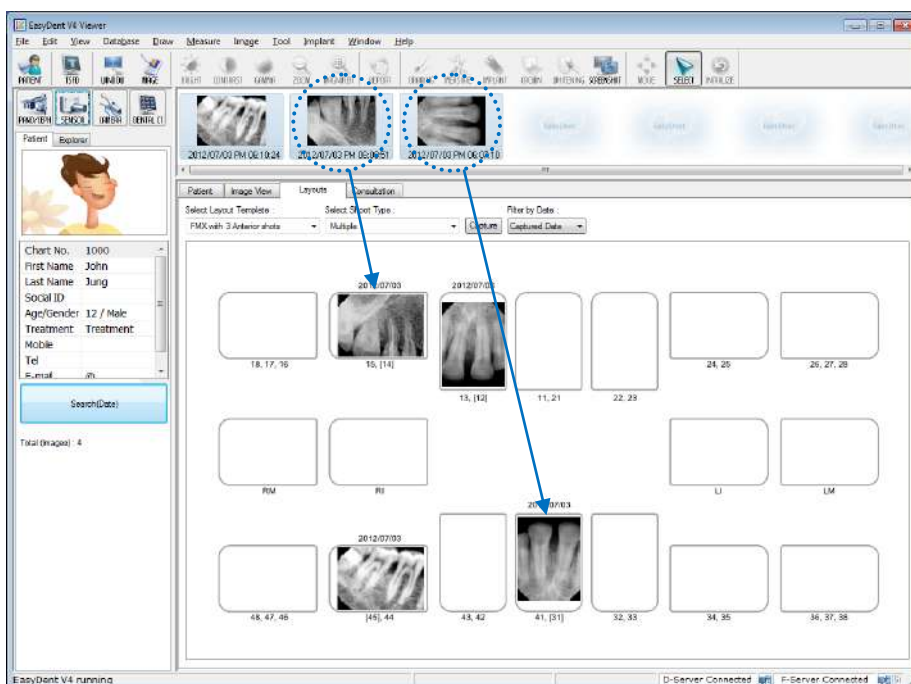

#### 4.3.4 Sequence Shot

You can capture multiple images according to a pre-saved order. Capturing according to the order will ensure the images appear automatically in the correct positions.

##### Step 1

---

Select your favorite sequence from the Shoot Type list. Red numbers represent the capture order.

The Sequence shot can be customized. Please refer to the EasyDent manual.

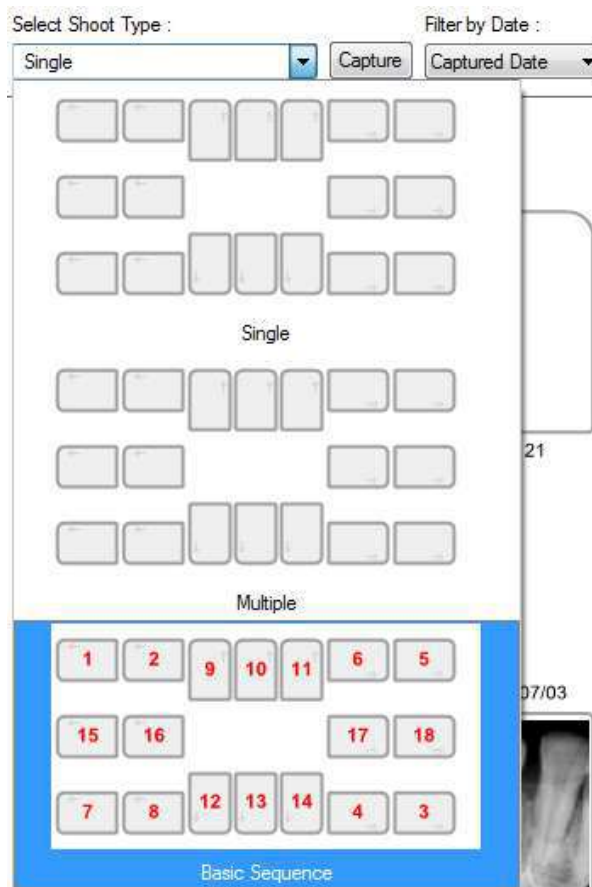

##### Step 2

---

Click the 'SENSOR (  )' button or 'Capture (  )' button.

##### Step 3

---

Position the sensor correctly.

## Step 4

Capturing according to the order, the images appear automatically in the correct positions.

Expose the X-ray after the “Please expose X-ray” message appears.

The message, “Optimizing Image... Please wait” appears while the image is being optimized.

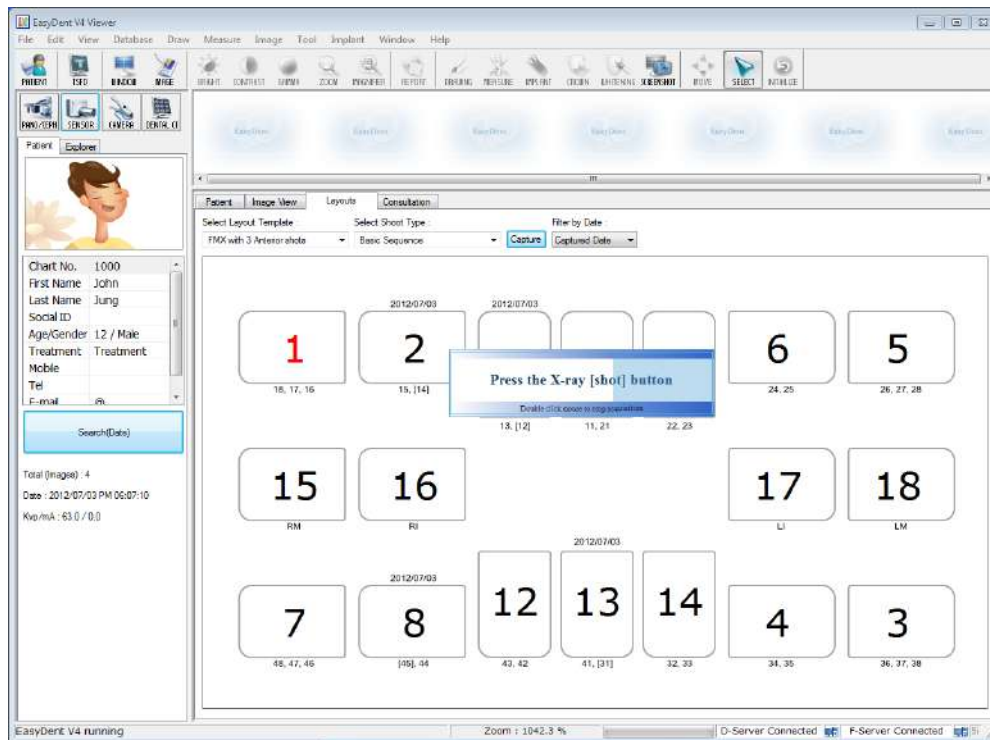

## Step 5

If you want to finish, double click the 'Press the X-ray (shot) button' message box. And then according to the capturing order, the images appear automatically in the correct positions.

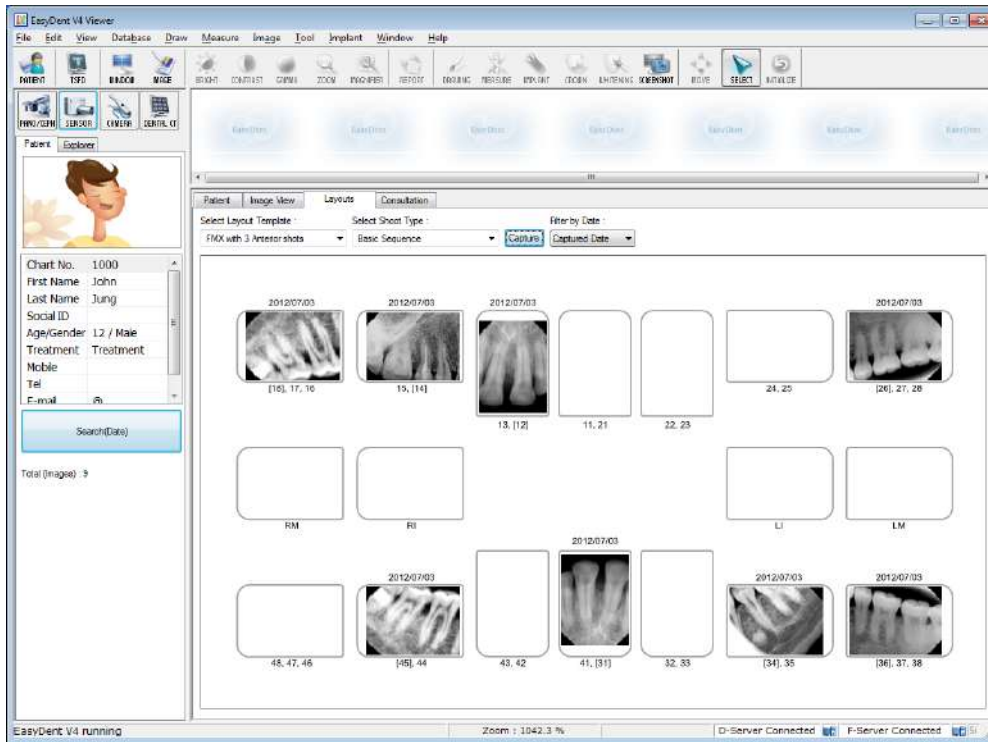

*All images are saved in the Database server automatically.*

*By double clicking on the image, the image is shown as large size at any function's table.*

## Chapter 5 Image Acquisition by using *EzDent-i*

### 5.1 Installation EzDent- i

In this step, *EzDent-i* will be installed. Alternatively, software which supports the Twain interface can be used instead of *EzDent-i*.

#### Step 1

Open [Setup.exe] from [Setup] folder to install *EzDent-i* Sever or Client for Windows.

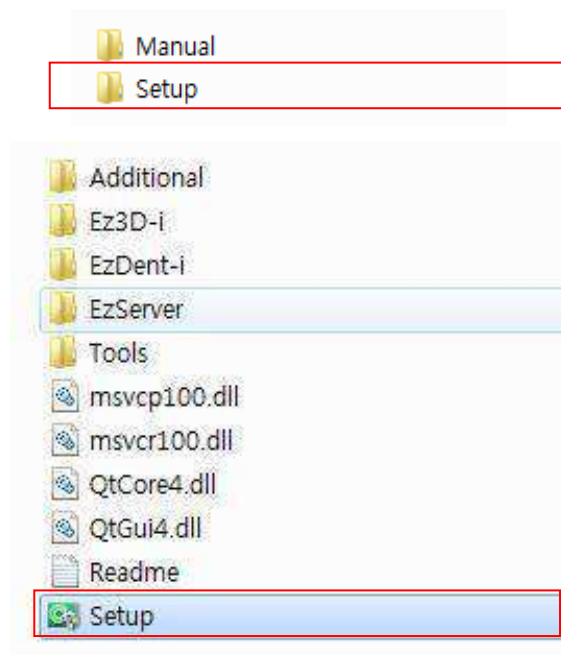

#### Step 2

The window for selecting installation mode will be shown. To setup the Server environment, start the installation by clicking the [Server] button.

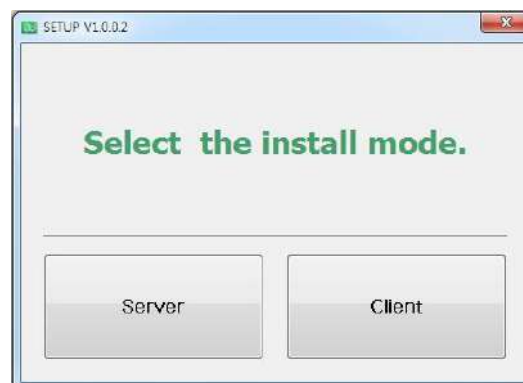

### Step 3

The window for component setting will be displayed  
 After selecting programs to install among EzServer, Consult Data, and Implant DB, click the [EzServer] button.

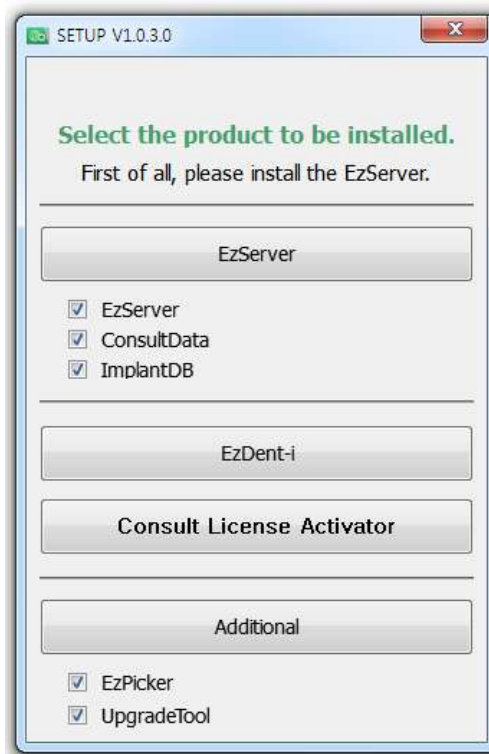

### Step 4

To continue click the [Next] button, followed by the [install] button to proceed.

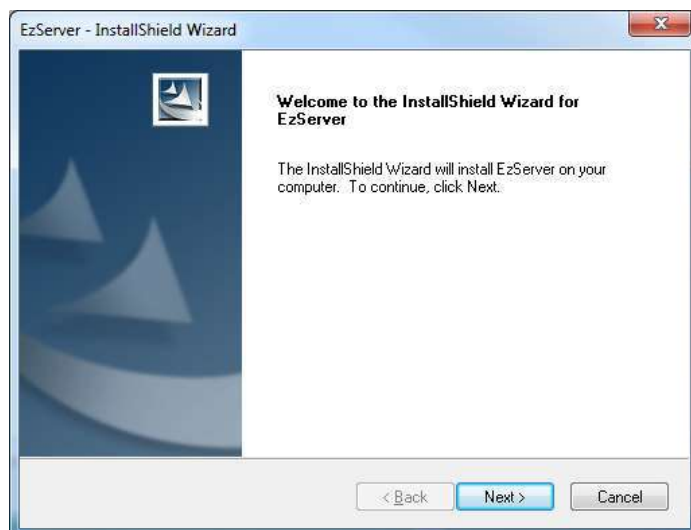

*When the installation of EzServer is complete, the other components (Consult Data and Implant DB) will automatically start installing.*

*If users did not select any other components, the installation is finished.*

## Step 5

Users can select the installation type of Implant DB, If users prefer to install multiple fixture models, select [complete], click the [Next] button to proceed.

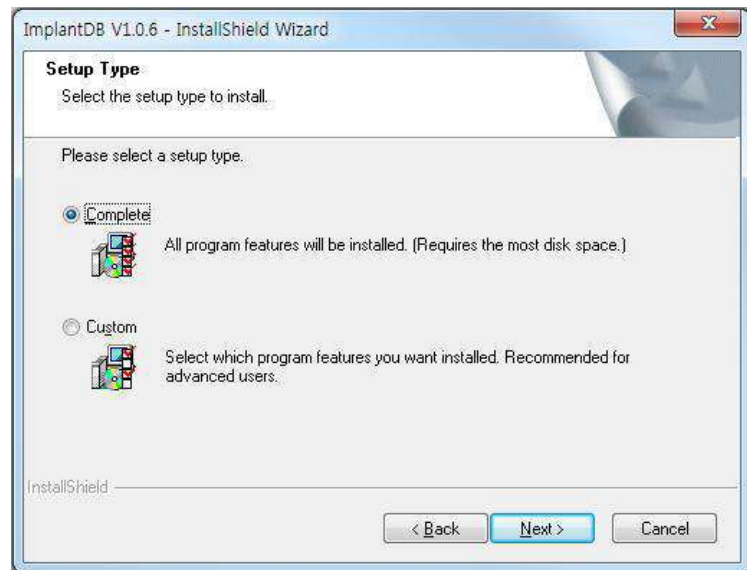

*If users prefer to install the implant models separately, select [Custom] and click the [Next] button*

## Step 6

In case that [Custom] in implant DB is selected, Select the name of manufacturers you want to install and click the [Next] button to go forward.

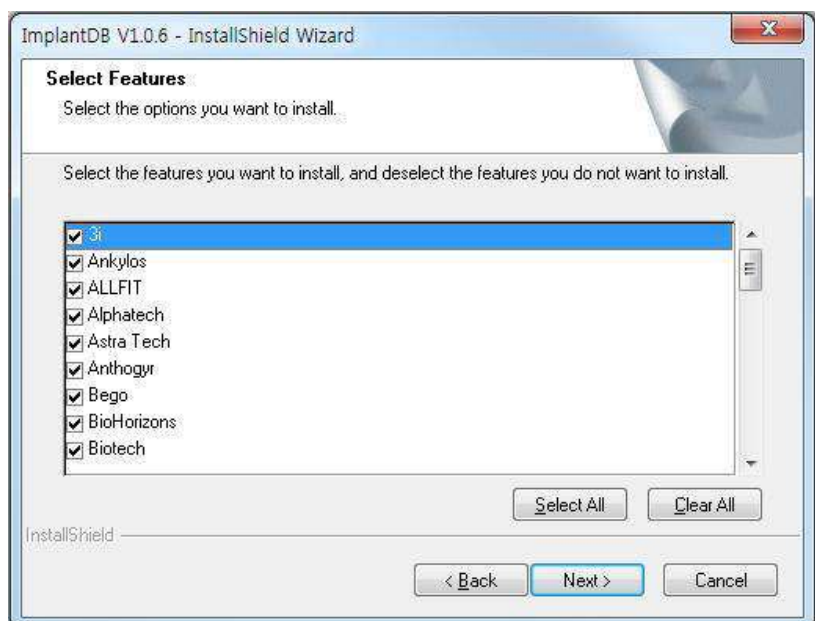

## Step 7

Compile [setup.exe] and click the button, [EzDent-i], 'The License Agreement' window will be shown. If the conditions are acceptable, select [I accept the terms of the license agreement] and click [Next] button

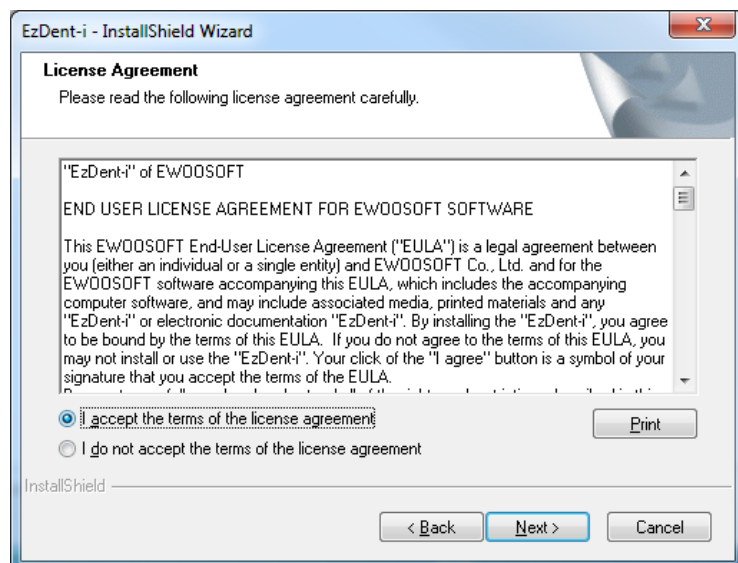



## Step 8

Type in the company and user name and click the [Next] button

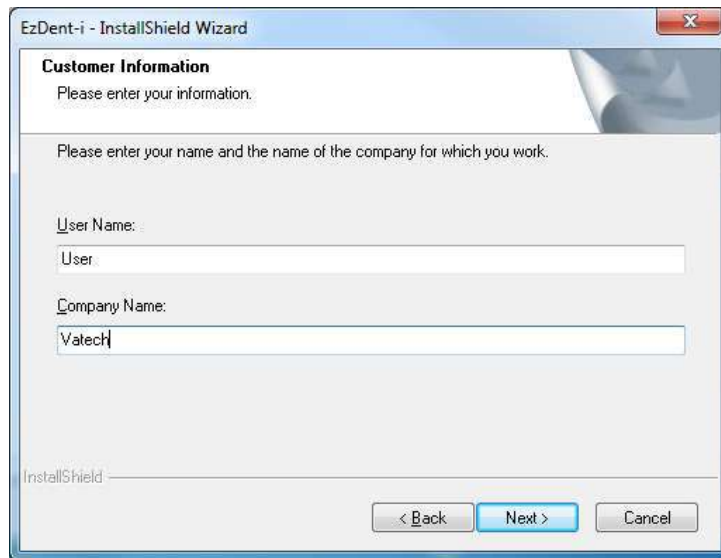

The screenshot shows the 'EzDent-i - InstallShield Wizard' dialog box. The title bar reads 'EzDent-i - InstallShield Wizard'. The main content area is titled 'Customer Information' and contains the text 'Please enter your information.' Below this, there is a sub-instruction: 'Please enter your name and the name of the company for which you work.' There are two text input fields: the first is labeled 'User Name:' and contains the text 'User'; the second is labeled 'Company Name:' and contains the text 'Vatech'. At the bottom of the dialog, there are three buttons: '< Back', 'Next >', and 'Cancel'. The 'Next >' button is highlighted in blue. The 'InstallShield' logo is visible in the bottom left corner.

## Step 9

After specifying the location to install the program, click the [Next] button to go forward.

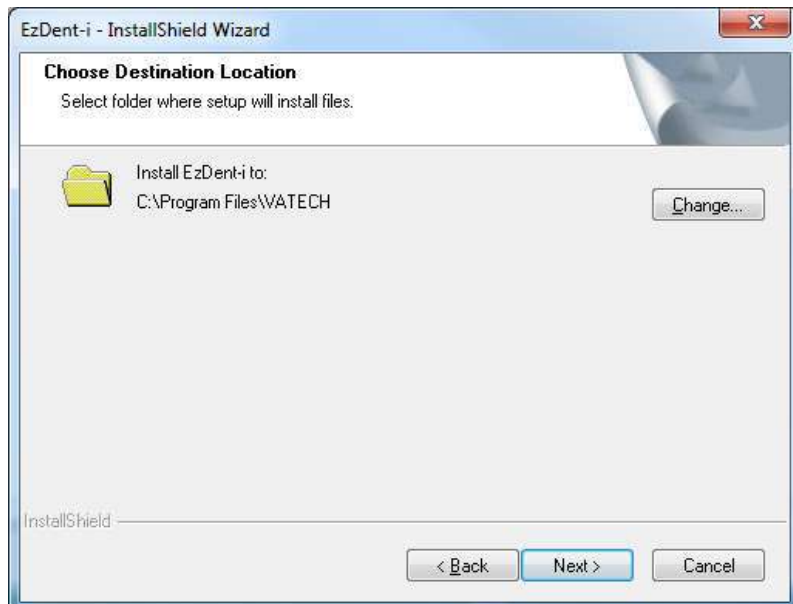

The screenshot shows the 'EzDent-i - InstallShield Wizard' dialog box. The title bar reads 'EzDent-i - InstallShield Wizard'. The main content area is titled 'Choose Destination Location' and contains the text 'Select folder where setup will install files.' Below this, there is a folder icon and the text 'Install EzDent-i to: C:\Program Files\WATECH'. To the right of this text is a 'Change...' button. At the bottom of the dialog, there are three buttons: '< Back', 'Next >', and 'Cancel'. The 'Next >' button is highlighted in blue. The 'InstallShield' logo is visible in the bottom left corner.

## Step 10

After installation of EzDent-i Console is complete, select [Yes, I want to restart my computer now] and click the [Finish] button. Then, the PC will be restarted.

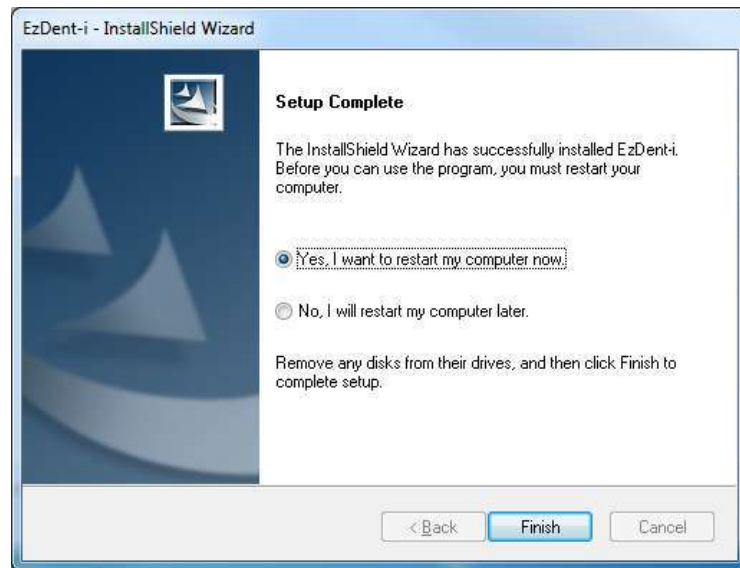

*It is strongly recommended to restart the PC to apply the changes occurring in the system during the EzDent-i installation.*

## 5.2 For Regular Users: Activating License With A USB Dongle Key.

### Step 1

Connect the USB Dongle Key to the PC, and open VTNL.exe

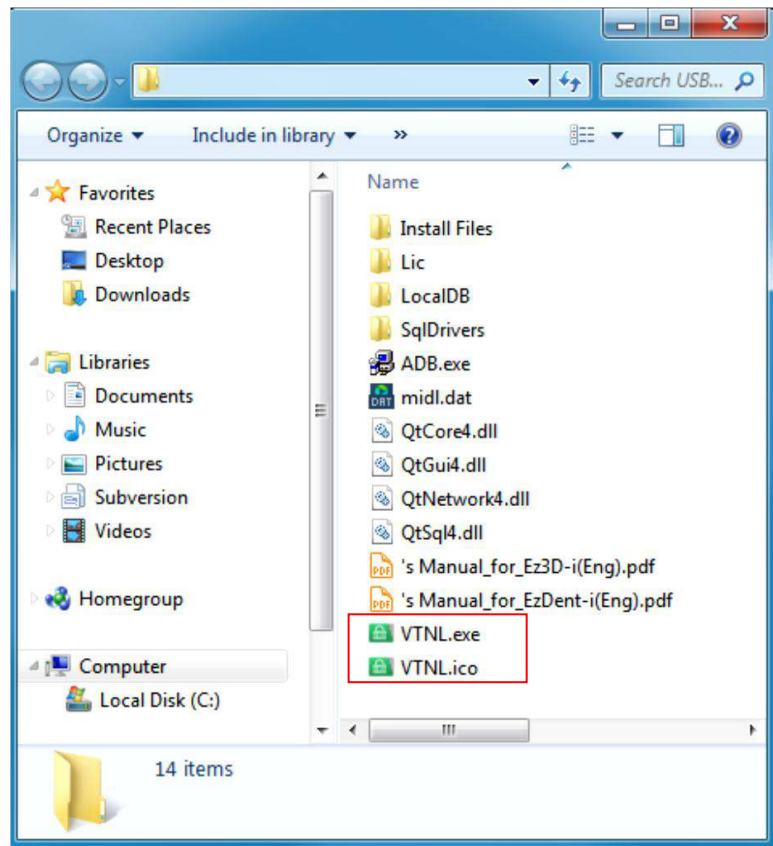

### Opening VTNL

To open VTNL program, install ADB.exe file first. If the executable file is not installed, the installation process of ADB program will automatically start when opening VTNL program.

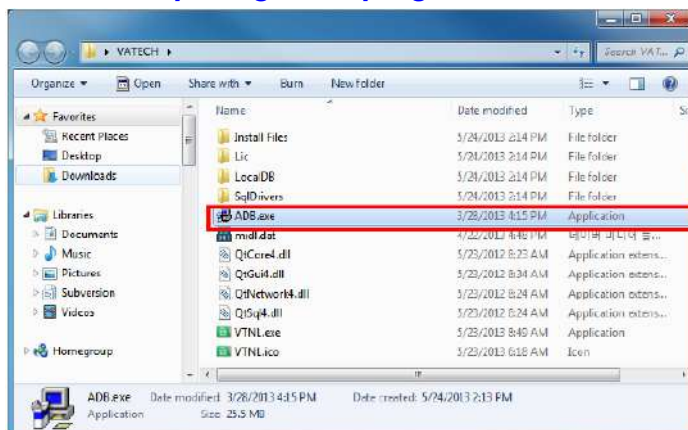

### Step 2

The following License Activation Wizard appears if you have not activated a license previously

Select the dongle key (first) item, and then click the [Next] button.

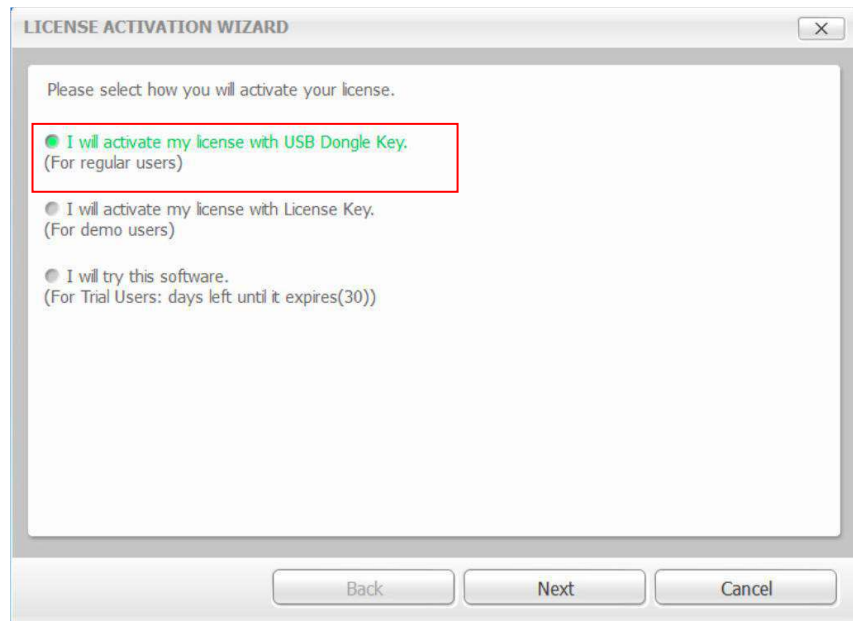

### Step 3

When the following VTLicense Plug in Option Window appears, select the license key from the list and install by clicking the [OK] button.

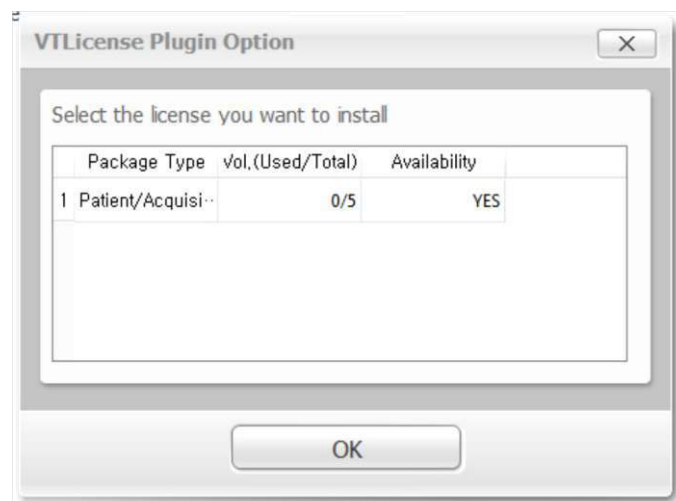

### Step 4

After clicking the [OK] button, the following VTLicense Activation Wizard window appears. Once the license has been activated, click on the [Finish] button to complete your activation. EzDent-i will then run automatically.

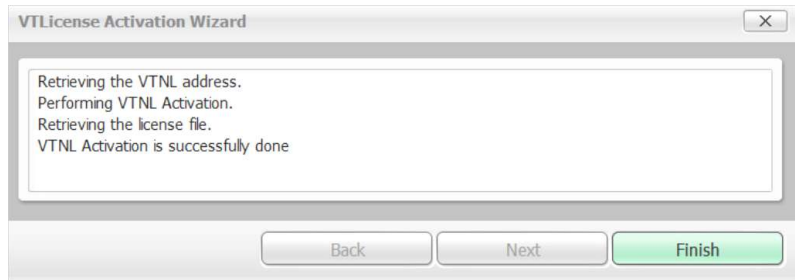

*Once the license has been activated, the user's PC will appear on the list of [Certifications] in the VTNL window.*

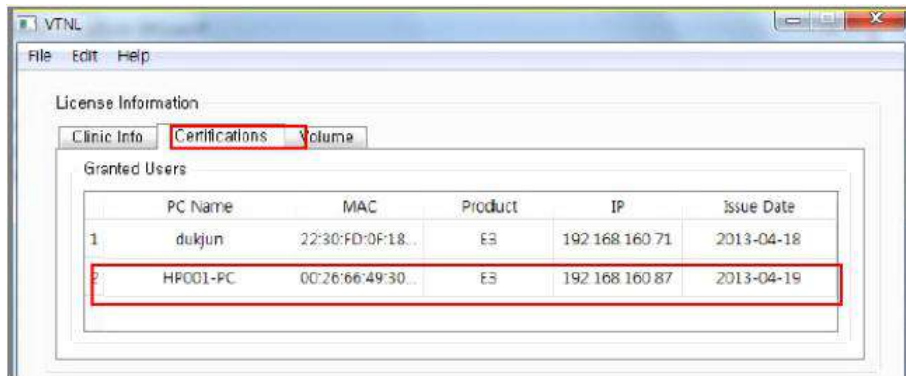

*The dongle license key number appears on the list of [Volume] in the VTNL window.*

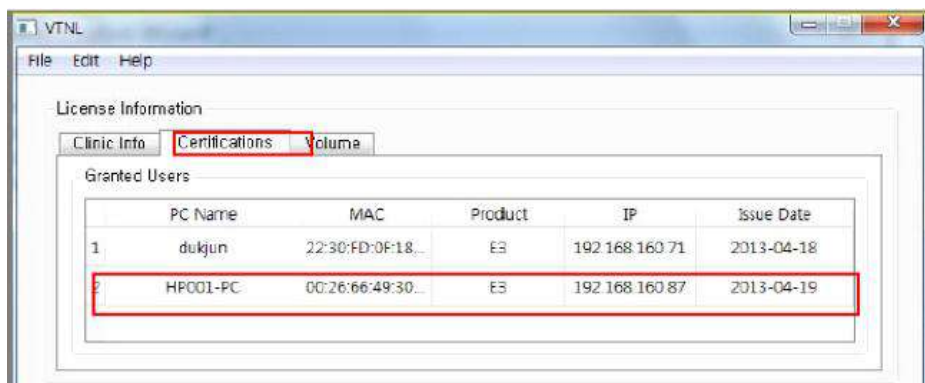

## 5.3 For Demo Users, Activating License With A License Key

### Step 1

Select the second option from the VTLicense Activation Wizard window



*For activating license using the license key, an internet connection must be available with the PC.*

### Step 2

Enter the EzDent-i user information and license key provided. And then click the [Next] button. You must enter more than 3 characters to activate the [Next] button

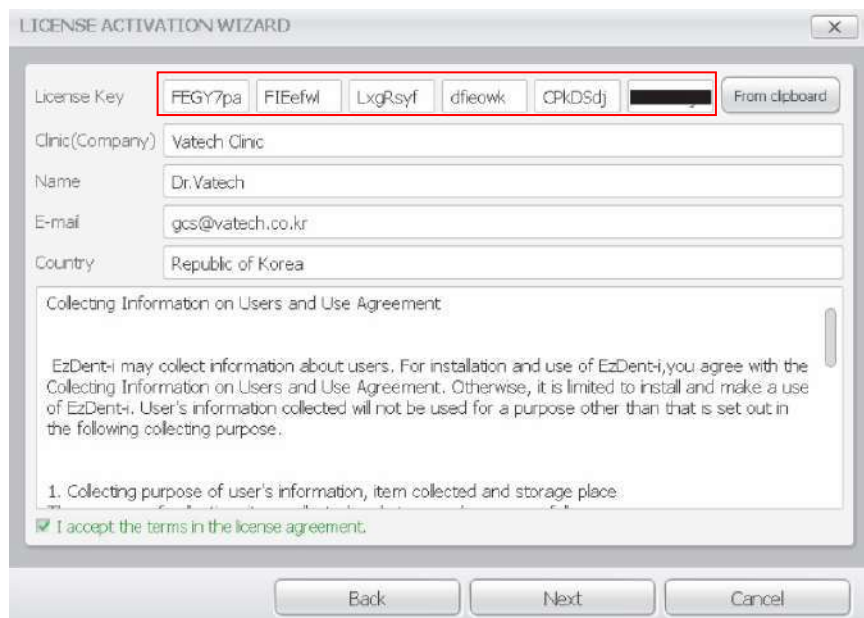

*Copy the license key with Ctrl+C button, and click the [From Clipboard] button for easier input.*

### Step 3

Upon the successful activation, the VTLicense Activation Wizard window will appear, including the remaining days. Click the [Finish] button to end the activation.

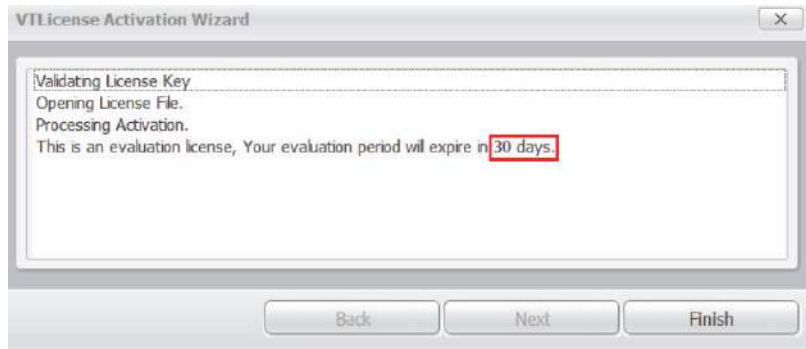

**Restart EzDent-i after the license activation. The user can check the information of the license by clicking 'Main menu button → About EzDent-i'.**

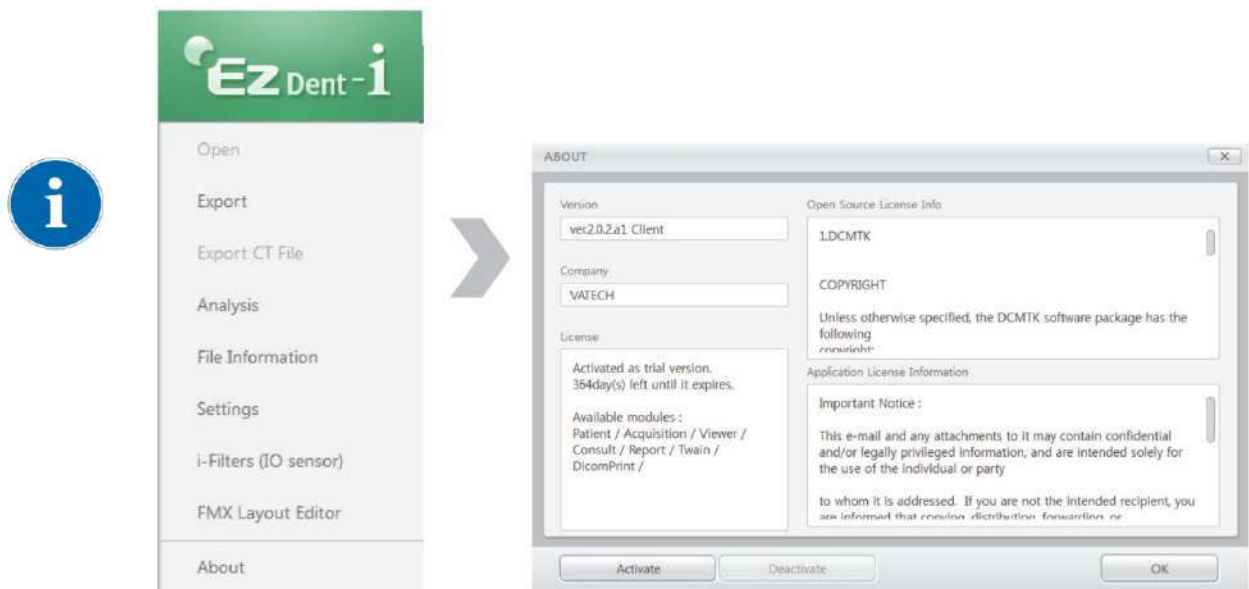

## 5.4 Consult DB License Activation



*Consult DB is for the users who have a Consult Premium License. After activating Consult DB License, the user can utilize video contents for consultation use.*

### Step 1

Open[Setup.exe] from [Setup] folder to install **EzDent-i** Server or Client for Windows

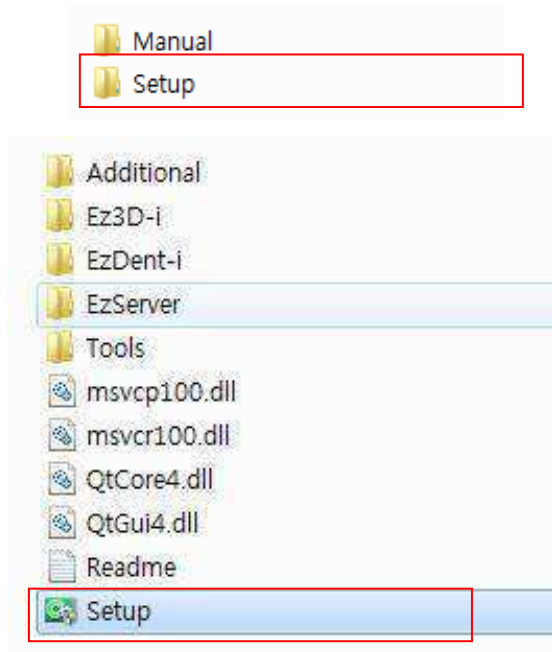

### Step 2

After selecting the install modes, Click the [Consult License Activator] button

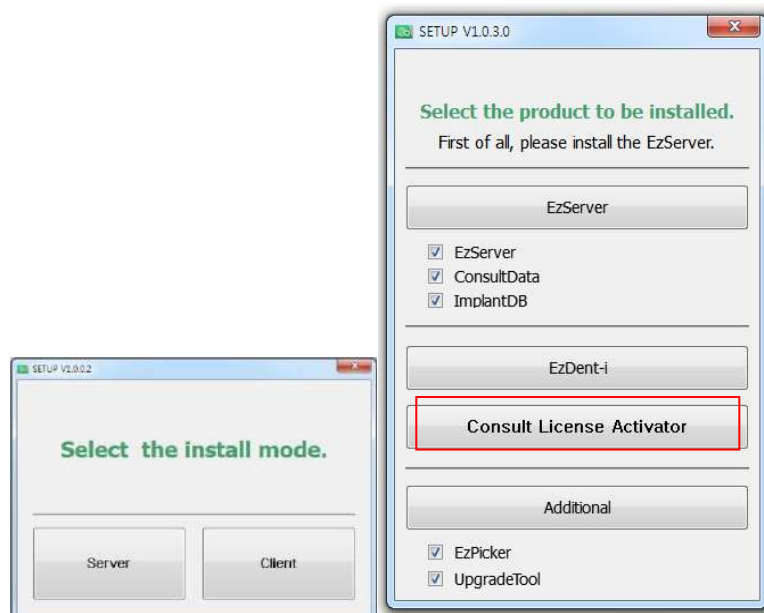



### Step 3

After checking the license information shown at the Consult Data License Activator window, Click the [Activate] button.

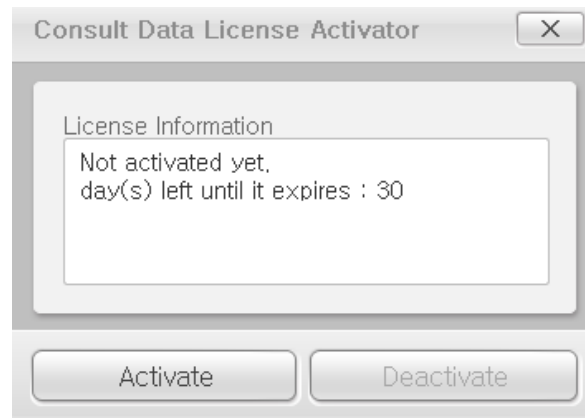

### Step 4

Select the second option from the VTLicense Activation Wizard window.



***For activating license using the license key, an internet connection must be available with the PC.***

### Step 5

Enter the EzDent-i user information and license key provided. And then click the [Next] button. You must enter more than 3 characters to activate the [Next] button.

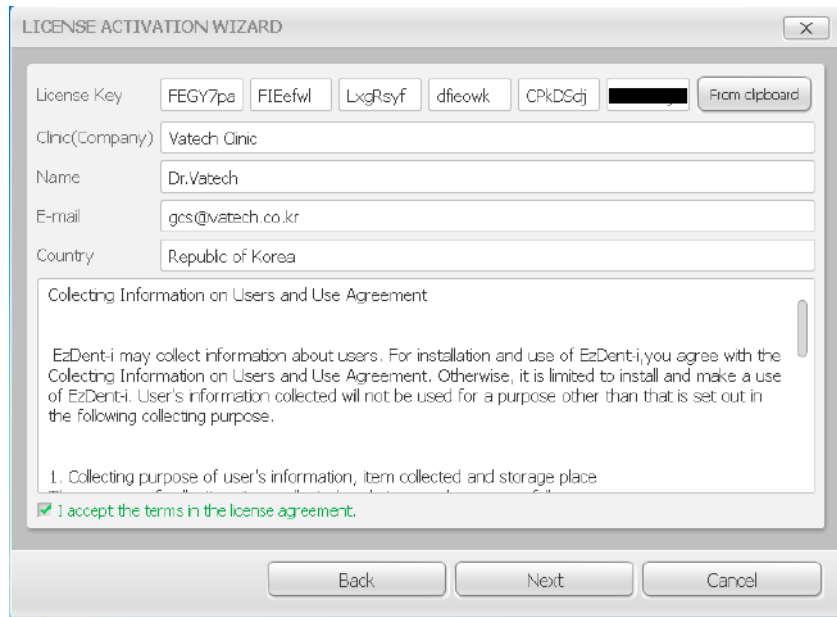

### Step 6

Upon successful activation, the VTLicense Activation Wizard window will appear, including the remaining days. Click the [Finish] button to end the activation.

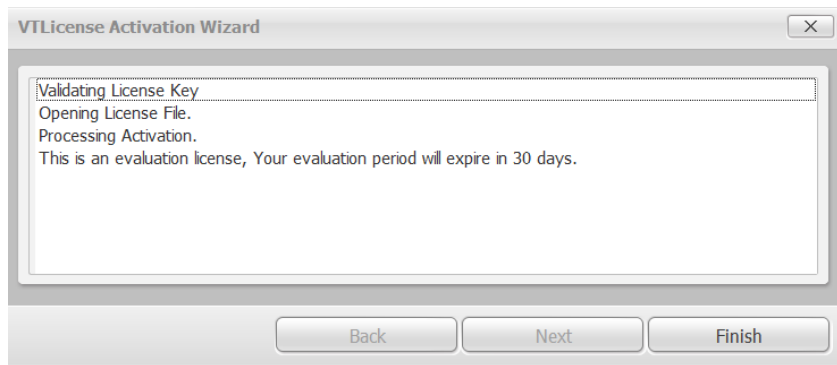

## 5.5 Preparing for Image Acquisition

- ① Turn on the computer.
- ② Run the **EzDent-i**.
- ③ Configure the required X-ray parameters (exposure time, etc.) for the X-ray generator.
- ④ For the operation test before X-ray exposure to patients, X-ray exposure as putting the coin on flat receptor of the sensor is recommend.
- ⑤ Position the **EzSensor HD** at the appropriate area in the mouth. The flat receptor side of the sensor must face the X-ray source. Note that the receptor side is marked with a label for ease of recognition.  
The use of the sensor positioning aid is recommended to guarantee that the sensor is parallel to the tooth and is at the appropriate angle for exposure
- ⑥ The use of the parallel technique with a positioning system or device, if possible, is highly recommended.
- ⑦ After preparing the sensor for exposure, acquire an image by pressing the exposure button of your X-ray source.



**Using the EzSensor HD  
with intraoral X-ray**



**Using the EzSensor HD  
with a Sensor positioning system(optional)**

## 5.6 Running the EzDent- i

### 5.6.1 Patient Registration

#### Step 1

Turn on the PC. Run **EzDent-i**. Click the 'Patient (  )' button to register a new patient.

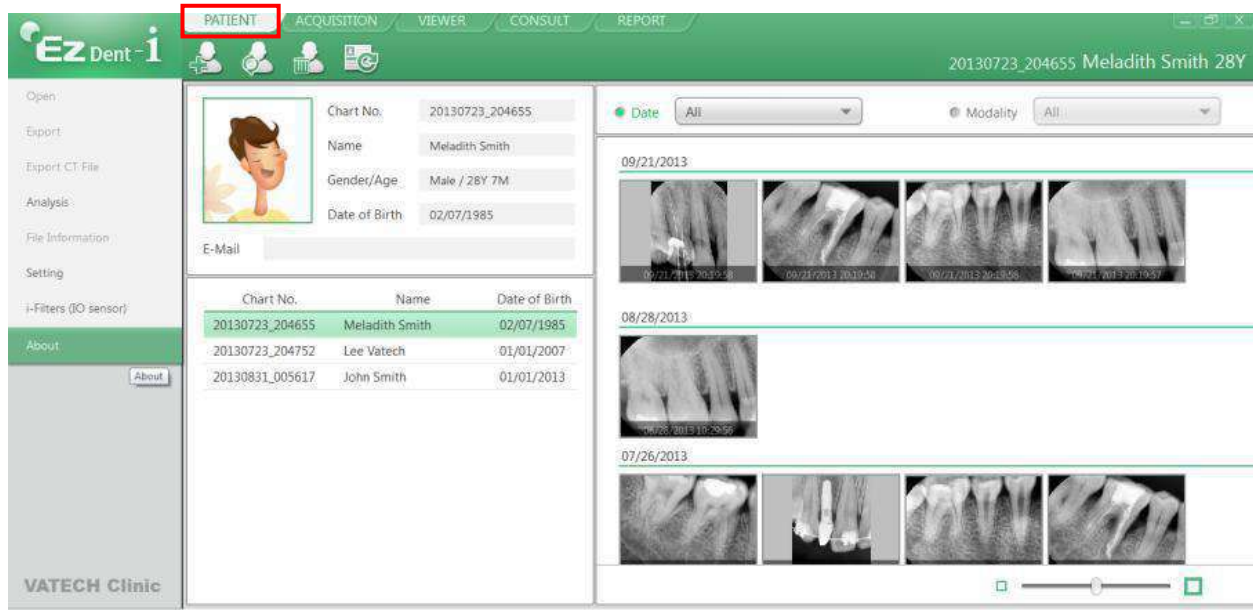

#### Step 2

The "Add Patient" registration window will appear. Register the new patient and click "Add."

The screenshot shows the "ADD PATIENT" registration window. The form contains fields for Chart No., Name (Last Name and First Name), Gender, Date of Birth (Year, Month, Day), and Email. The "Add" and "Cancel" buttons are visible at the bottom.

5.6.2 Acquiring Image

Step 1

The Acquisition Tab allows the user to capture/store images with the IO Sensor.

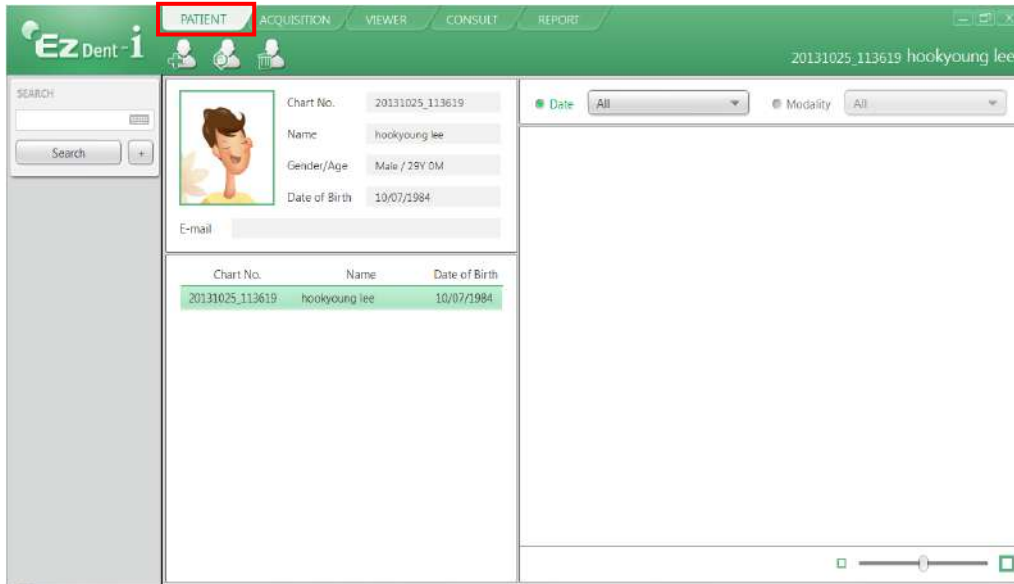

*By clicking the logo, “EzDent-i” as below, you can use normal resolution mode.*

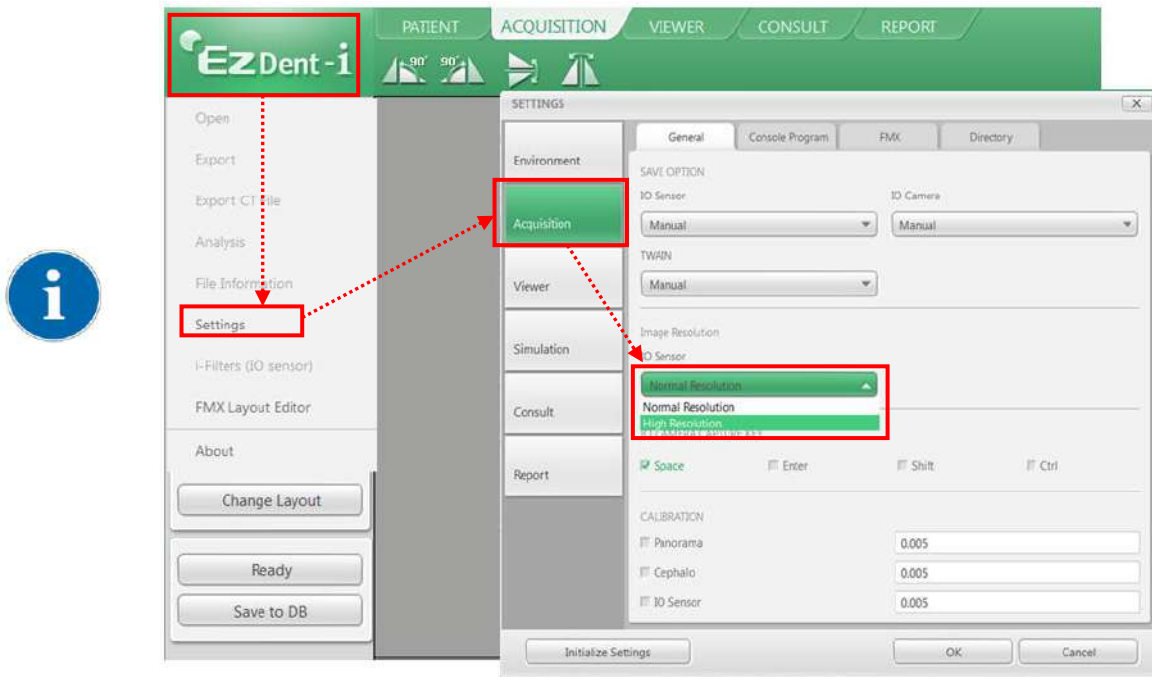

**i** *Normal Resolution mode / High Resolution mode  
Select and it is available*

### Step 2

Click the [IO Sensor] button in the Acquisition tab. Once the IO sensor is connected, the layout will change depending on the selected device.

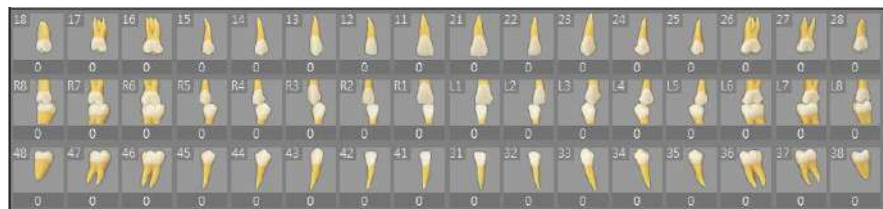

### Step 3

Click the [Ready] button after positioning the patient. If the IO Sensor equipment is properly connected, the image acquisition mode will be initiated.

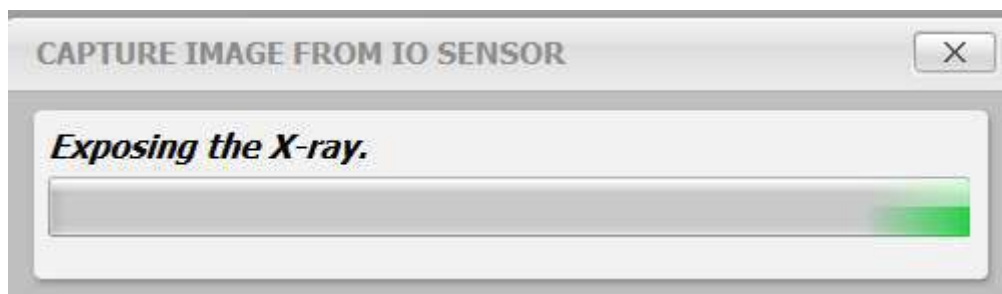
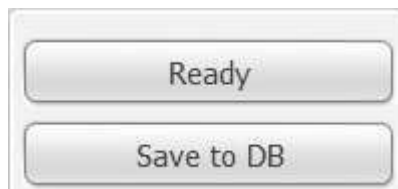

*By double clicking the workspace from the ACQUISITION tab, EzDent-i will be ready for image acquisition. The [Ready] button provides the same function.*



#### **Step 4**

Using the exposure switch, shoot the x-ray and the image will be acquired.  
The process of acquiring the image is complete.

## Step 5

Select the images from the thumbnails, and then click the [Save to DB] button. The captured images will be stored in the DB.

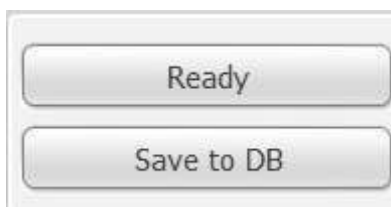

*If the user wants to select more than 2 images, hold the Ctrl key on the keyboard and click the desired images from the thumbnails.*



*To change the way of storing the acquired images, change the options in settings. With the option "Auto DB Save," all acquired images are automatically stored in DB. Another option, Manual, only stores selected images in DB.*



### 5.6.3 Image View

#### Step 1

Enter the name or chart number of the patient in the Patient Search window and click the [Search] button or press the Enter key. The search result will appear.

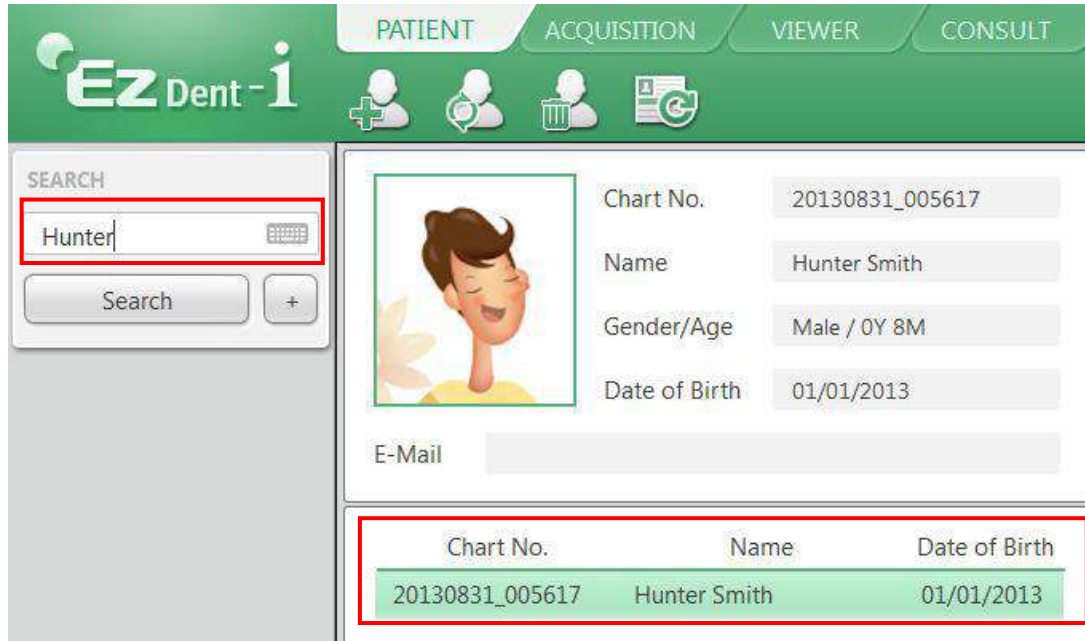

#### Step 2

Double Click the selected "Patient List".  
The images will be displayed in the VIEWER tab.



## Chapter 6 Maintenance

For optimal performance, MANUFACTURER recommends the working area be kept clean. There are no specific cleaning requirements for the **EzSensor HD** beyond normal care and attention for aesthetic appearances.

### 6.1 Visual Inspection

Like all electrical systems or device, **EzSensor HD** requires not only correct usage, but also visual inspection prior to operation, as well as routine checks at regular intervals. These precautions will help ensure that the Product operates accurately, safely, and efficiently.

Before use, the operator should check the Product for any signs of physical damage or defects. If something out of order is suspected, contact your local Product distributor for further instructions on how to proceed.

### 6.2 Periodic Maintenance

Periodic maintenance should be performed as necessary and in accordance with monitored frequency in the table below. Maintenance should consist of various checks performed by the operator or by a qualified service technician.

- Check that all cables connected to the **EzSensor HD** are undamaged.
- Check for any external damage to the **EzSensor HD** that may compromise its ability to be safely operated. If the **EzSensor HD** is defective, the sensor should be returned to the manufacturer for repair.
- Arrange the sensor and the control box USB cable to prevent damage of the cable's rubber tube. They should not be stepped on nor bent and pressed under table legs.



***A qualified service technician is a person authorized by Manufacturer or its distributors.***

---

**6.2.1 Test List**

Test Item	Frequency	Equipment
Connection	Daily	Sensor & PC
Cable	Monthly	Cable
Resolution	Annually	<i>Resolution Patterns, Gammex Rmi</i>

**6.2.2 Connection**

●Object

Check the normal operation of PC when the sensor is connected to the PC

●Procedure

1. Connect the EzSensor HD USB Connector to the USB Port
2. Confirmation of Driver installation at the Device Manager

Method of Confirmation:

Windows 7 : Control Panel → System and Security → System → Device Manager

Windows XP : Settings → Control Panel → System → Hardware → Device manager



3. Select 'VH EzSensor-N x.x', located under Imaging Devices. You should see the message, "This device is working properly".

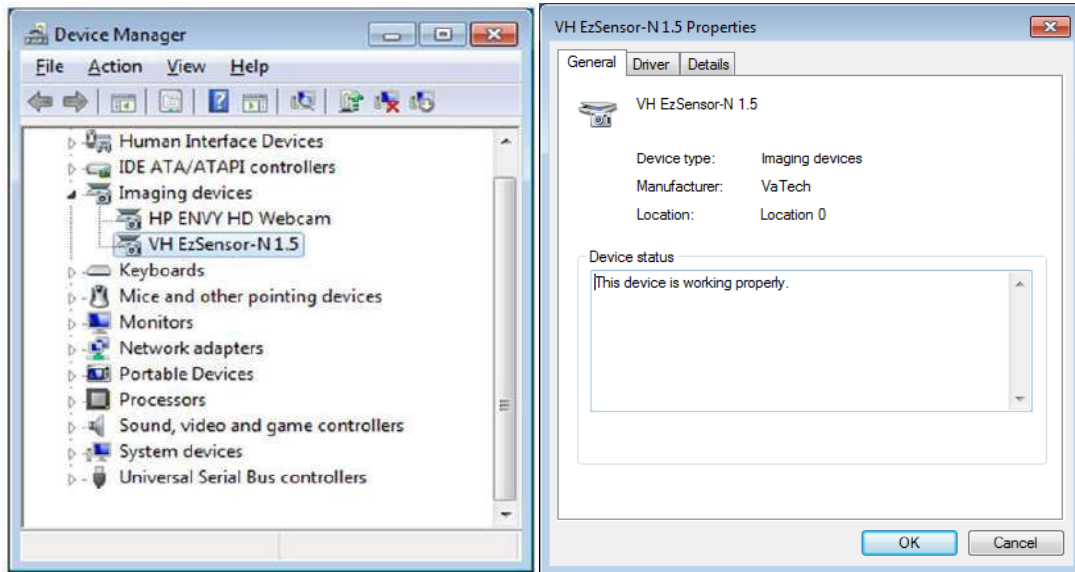

### 6.2.3 Cable

- Object

Prevent the sensor malfunction caused by the occurrence of external cable stress.

- Procedure

1. Arrange the sensor and the control box USB cable to prevent damage of the cable's rubber tube. They should not be stepped on nor bent and pressed under table legs.
2. Check that all cables connected to the EzSensor HD are undamaged.

### 6.2.4 Resolution

- Object

Verify the resolution of EzSensor HD

- Procedure

1. Run EasyDent(EzDent-i) with connecting EzSensor HD .
2. Attach resolution phantom on the center of the detector with diagonal direction.
3. Set X-ray Condition to 60~70kVp 50mAs and SID to 28cm
4. Confirm that the resolution is over 8lp/mm.

## 6.3 Care and Cleaning

In order to prevent infection, wipe the front plate of the sensor unit with ethanol or glutaraldehyde solution to disinfect it each time a different patient uses the instrument. If you plan to use a disinfectant other than those specified above, or you are mixing another disinfectant with ethanol, please consult a specialist because it may damage the plate.

To clean the **EzSensor HD**, the following solutions are listed below. Please observe the precautions noted.

- Mild soap and water
- Isopropyl alcohol (70%)
- Most alcohol and ammonia based cleaners
- Mild, non-abrasive cleaners

Do not soak or immerse any part of the Product, and be sure to dry it completely after cleaning. Clean the surface of the Product by moistening it with a soft cotton swab dipped in one of the cleaning solutions listed above. Gently wipe the surface end-to-end in straight lines, without applying any pressure. Make sure the liquid does not penetrate the Product through the USB cable or the sensor cable connectors.

After cleaning the surface of the **EzSensor HD**, use a clean lint-free cloth to dry the Product, as required, until the surface is clean.

※ Clean the silicone cover using the same method.

※ Do not use the following cleaning materials.

- Hard brushes or scrapers of any kind
- Strong acids or alkaloids

## 6.4 Precautions

- Do not soak the sensor in water or alcohol.
- Authorized service personnel can repair calibration issues.
- Service personnel cannot handle problems that are not mentioned in this manual.  
Please request repairs to the manufacturer through a VATECH dealer.
- Equipment and accessories are to be disposed safely at the end of the Product life cycle. National regulation must be observed.

## 6.5 Product complaint

Any health care professional (e.g., a customer or user of Product or system) who has any complaints should notify his or her distributor first, who will handle such issues.

If the Product may have caused or contributed to a serious injury of a patient, your distributor should immediately notify the manufacturer by telephone, fax, or written correspondence. The manufacturer will report it to the government according to their reporting process.



***Do not modify this equipment without authorization of the manufacturer.***

---

---

## Appendix

### A.1 X-ray Exposure Guide

The required X-ray dose for the best image is dependent on the following:

- X-ray source (tube assembly, manufacturer, AC/DC, etc.)
- Distance between beam focus and sensor
- Tooth (object) to be X-rayed
- Bone density and age of patient
- Miscellaneous circumstances, etc.

The X-ray dose influences image quality. Based on fundamental laws of physics, an insufficient dose generally means higher image noise, which leads to poor detail discrimination. On the other hand, an excessively high dose can cause the sensor to be overexposed. This is also perceptible by a decrease in detail discrimination, specifically in darker areas.

The effect of image processing reduces the difference between image qualities of different doses. Users can adjust brightness and contrast in the option menu.

The recommended exposure dose is from 300 $\mu$ Gy to 600 $\mu$ Gy when measuring without an object. Exposure time corresponding to the dose may vary depending on the X-ray equipment used. Recommended exposure times according to positions are as shown on the Exposure Time Table.

The X-ray dose is maintained through tube voltage (kVp) and current (mA), as well as exposure time according to the signal level.



*Since the exposure time depends on the diagnostic problem as well as the clinical situation, the selection of an adjustment is the responsibility of the treating physician.*

---

---



CAUTION

*Image degradations caused by overexposure of the sensor cannot be compensated, but an insufficient dose can be partially compensated through image processing.*

---

---

<Table 4. Recommendation on Exposure Time >

Exposure condition	Dose (μGy)	60kvp 6mA	60kVp 2mA	65kVp 5mA
<b>Patient</b>		Adult	Adult	Adult
<b>SID</b>		<b>28cm</b>	<b>18cm</b>	<b>28cm</b>
<b>Intra Oral X-ray Unit (Model name)</b>	No Filter	VX 70	AnyRay	ESX
		Approximate Exposure Time (sec)		
Incisor & Canine	300 ~ 500	0.12 ~ 0.2	0.1 ~ 0.2	0.18 ~ 0.28
Molar	400 ~ 600	0.16 ~ 0.25	0.15 ~ 0.25	0.24 ~ 0.34

\* SID : Source to imaging receptor Distance

\*Recommendation on Exposure Time is limited to Intra Oral X-ray Unit in the above table



***For larger body types : increase the source current by 25%***

***For children(5~21age) : reduce the source current (or Exposure time)  
by 20%***

***For edentulous patients : reduce the source current by 20%.***



***Since the X-ray exposure condition can be changed depending on the age, gender and bone density of the patient, in case of Pediatric, X-ray exposure condition can be changed by expert's judge.***

***For further information, please refer to FDA Pediatric X-ray Imaging webpage,***

[http://www.fda.gov/radiation-](http://www.fda.gov/radiation-emittingproducts/radiationemittingproductsandprocedures/medicalimaging/ucm298899.htm)

[emittingproducts/radiationemittingproductsandprocedures/medicalimaging/ucm298899.htm](http://www.fda.gov/radiation-emittingproducts/radiationemittingproductsandprocedures/medicalimaging/ucm298899.htm)



***The X-ray dose required for image acquisition can vary depending on the X-ray source and environmental circumstances. You must maintain the exposure time and change the kVp and mA values according to the signal level. In addition, if the X-ray source and the distance to the sensor were changed during the initial installation, the distance (from cone to detector) must be changed to the 80mm setting.***

***The exposure time may vary depending on the age, gender, and bone density of the patient.***



## A.2 Error Message

1. USB device driver is not installed.

- Solution: Please install the device driver again.

2. Control box cannot be initialized.

- Solution: Check and re-connect the USB PC cable.

3. USB device driver is not working properly.

- Solution: Re-install the driver.

4. Capture program is already running.

- Solution: Please close any other programs.

5. Detector response time-out.

- Check and re-connect the USB PC cable. Please try again.

If the same message is displayed again, contact Customer Service.

6. Data communication error.

- Solution: Re-connect the USB PC cable.

7. Canceled image capturing.

- This means that the user canceled image capture. Please try again.

8. Cannot find dark frame.

- Solution: Restore the EzSensor HD's calibration data from the S/W installation CD or re-calibrate the sensor. If the same message is displayed again, contact Customer Service.

9. Cannot find bright frames for calibration.

- Solution: Reinstall the EzSensor HD driver.

10. Bad Pixel Map correction error.

- Solution: Restore the EzSensor HD's calibration data from the S/W installation CD or re-calibrate the sensor. If the same message is displayed again, contact Customer Service.

11. Wrong image processing parameters.

- Solution: Check the X-ray source. If the problem persists, call for technical assistance.

12. Cannot load 'EzSensor.dll'.

- Solution: Please re-install the acquisition software.

13. Require 'EzSensor.dll' was damaged.

- Solution: Please re-install the acquisition software.

### A.3 Troubleshooting

If you experience any problems regarding the **EzSensor HD** during operation, please refer to the troubleshooting table below for corrective measures. If the problem persists, please contact your local Product distributor.

<Table 5. Troubleshooting Table>

Item	Description	Corrective Measure
1	A 'PID 2XXX NO; #0 (Check Connection)' error message is displayed.	Unplug the USB PC cable from the PC connector. Open the Windows Device Manager and check that the device is installed correctly. Alternatively, try another USB port on your computer.

## A.4 Electromagnetic Compatibility Information

<b>Guidance and manufacturer's declaration – electromagnetic emissions</b>		
The Product is intended for use in an electromagnetic environment as specified below. The customer or the user of the Product should ensure that it is used in such an environment.		
<b>Emissions test</b>	<b>Compliance</b>	<b>Electromagnetic environment - guidance</b>
RF emissions CISPR 11	Group 1	The Product uses RF energy only for its internal functions. Therefore, its RF emissions are very low and are not likely to cause any interference to nearby electronic equipment.  The Product is suitable for use in all establishments, including domestic establishments, and those directly connected to a personal computer USB port used for domestic purposes.
RF emissions CISPR 11	Class A	
Harmonics emission IEC 61000-3-2	A	
Voltage fluctuation IEC 61000-3-3	Complies	

<b>Guidance and manufacturer's declaration – electromagnetic emissions</b>			
The Product is intended for use in an electromagnetic environment as specified below. The customer or the user of the Product should ensure that it is used in such an environment.			
<b>Immunity test</b>	<b>IEC 60601 test level</b>	<b>Compliance level</b>	<b>Electromagnetic environment – guidance</b>
Electrostatic discharge (ESD) IEC 61000-4-2	± 6 kV contact ± 8 kV air	± 6 kV contact ± 8 kV air	Floors should be wood, concrete or ceramic tiles. If floors are covered with synthetic material, relative humidity should be at least 30%.
Electrical fast transient/burst IEC 61000-4-4	± 2 kV for power supply lines ± 1 kV for input/output lines	± 2 kV for power supply lines ± 1 kV for input/output lines	Mains power quality should be that of a typical commercial or hospital environment.
Surge IEC 61000-4-5	± 1 kV differential mode ± 2 kV common mode	± 1 kV differential mode ± 2 kV common mode	Mains power quality should be that of a typical commercial or hospital environment.
Voltage dips, short interruption, and voltage variations on power supply input lines IEC 60601-4-11	< 5 % $U_T$ (> 95 % dip in $U_T$ ) for 0.5 cycles  40 % $U_T$ (60 % dip in $U_T$ ) for 6 cycles  70 % $U_T$ (30 % dip in $U_T$ ) for 30 cycles  < 5 % $U_T$ (> 95 % dip in $U_T$ ) for 5 s	< 5 % $U_T$ (> 95 % dip in $U_T$ ) for 0.5 cycles  40 % $U_T$ (60 % dip in $U_T$ ) for 6 cycles  70 % $U_T$ (30 % dip in $U_T$ ) for 30 cycles  < 5 % $U_T$ (> 95 % dip in $U_T$ ) for 5 s	Mains power quality should be that of a typical commercial or hospital environment. If the user of the Product requires continued operation during power mains interruptions, it is recommended that the Product be powered from an uninterruptible power source or battery.
Power frequency	3.0 A/m	3.0 A/m	Power frequency magnetic fields should

(50/60 Hz) IEC 61000-4-8			be at levels characteristic of a typical location in a typical commercial or hospital environment.
Conducted RF IEC61000-4-6	3 Vrms 150 kHz to 80MHz	3 Vrms 150 kHz to 80MHz	<p>Portable and mobile RF communications equipment should be used no closer to any part of the Product, including cables, than the recommended separation distance calculated from the equation applicable to the frequency of the transmitter.</p> <p><b>Recommended separation distance</b></p> $d = \left[ \frac{3,5}{V_1} \right] \sqrt{P}$
Radiated RF IEC61000-4-3	3 V/m 80 MHz to 2.5GHz	3 V/m 80 MHz to 2.5GHz	<p><b>Recommended separation distance</b></p> $d = \left[ \frac{3,5}{E_1} \right] \sqrt{P} \text{ 80 MHz to 800 MHz}$ $d = \left[ \frac{7}{E_1} \right] \sqrt{P} \text{ 800 MHz to 2,5 GHz}$ <p>Where <math>P</math> is the maximum output power rating of the transmitter in watts (W) according to the transmitter manufacturer and <math>d</math> is the recommended separation distance in meters (m).</p> <p>Field strengths from fixed RF transmitters, as determined by an electromagnetic site survey, (a) Should be less than the compliance level in each frequency range (b).</p> <p>Interference may occur in the vicinity of equipment marked with the following symbol:</p> 
<p><b>Note 1)</b> <math>U_r</math> is the A.C. mains voltage prior to application of the test level.  <b>Note2)</b> At 80 MHz and 800 MHz, the higher frequency range applies.  <b>Note3)</b> These guidelines may not apply in all situations. Electromagnetic propagation is affected by absorption and reflection from structures, objects and people.</p>			
<p><b>a</b> Field strengths from fixed transmitters, such as base stations for radio (cellular/cordless) telephones and land mobile radios, amateur radio, AM and FM radio broadcast and TV broadcast cannot be predicted theoretically with accuracy. To assess the electromagnetic environment due to fixed RF transmitters, an electromagnetic site survey should be considered. If the measured field strength the location in which the Product is used exceeds the applicable RF compliance level above, the EUT should be observed to verify normal operation. If abnormal performance is observed, additional measures may be necessary, such as re-orienting or relocating the Product.  <b>b</b> Over the frequency range 150 kHz to 80 MHz, field strengths should be less than <math>[V_1]</math> V / m.</p>			

**Recommended Separation Distances Between Portable and Mobile RF Communications Equipment and the Product.**

The Product is intended for use in an electromagnetic environment in which radiated RF disturbances are controlled. The user The Product can help prevent electromagnetic interference by maintaining a minimum distance between portable and mobile RF communications equipment (transmitters) and The Product as recommended below, according to the maximum output power of the communications equipment.

Rated maximum output power (W) of transmitter	Separation distance (m) according to frequency of transmitter		
	150 kHz to 80 MHz	80 MHz to 800 MHz	800 MHz to 2.5 GHz
0.01	0.12	0.12	0.23
0.1	0.37	0.37	0.74
1	1.17	1.17	2.33
10	3.70	3.70	7.37
100	11.70	11.70	23.30

For transmitters rated at a maximum output power not listed above, the recommended separation distance (d) in meters (m) can be estimated using the equation applicable to the frequency of the transmitter, where P is the maximum output power rating of the transmitter in watts (W) according to the transmitter manufacturer.

**Note 1:** At 80 MHz and 800 MHz, the separation distance for the higher frequency range applies  
**Note 2:** These guidelines may not apply in all situations. Electromagnetic propagation is affected by absorption and reflection from structures, objects, and people.

---

**Copyright by © 2013 Rayence Co., Ltd.**

---

The information in this document is subject to change without notice and does not represent a commitment on the part of the vendor.

This document contains materials protected under International Copyright Laws. All rights reserved. No part of this manual may be reproduced, transmitted, or transcribed without the expressed written permission of the manufacturer and authors of this manual.

If you do not properly set the Product, which in turn causes the Product to malfunction or fail, we cannot guarantee any responsibility.



Rayence Co., Ltd.

Web Site ▶ [www.rayence.com](http://www.rayence.com)

14, Samsung 1-ro 1-gil, Hwaseong-si, Gyeonggi-do, Korea



CE symbol grants the product compliance to the European Directive for Medical Devices 93/42/EEC as a class IIa device.

Authorized by SGS United Kingdom Ltd



VATECH Dental Manufacturing Ltd.

Chancery House, St. Nicholas Way, Sutton, SM1 1JB UK

Tel: +44 020 8652 1900, Fax: +44 020 8652 1909

VATECH America Inc.

2200 Fletcher Ave. Suite 705A, Fort Lee, NJ07024

Tel: +1 888 396 6872

Document No. R-USM-712

Release Version 1.4

Dated Jul. 8, 2016



**Distributed by**

**Vatech Global**

13, Samsung 1-ro 2-gil, Hwaseong-si, Gyeonggi-do, Korea