

Industrial design patent No.: CN 200830300434.9
Please read this manual before operating

DTE[®] D7

ULTRASONIC SCALER INSTRUCTION MANUAL

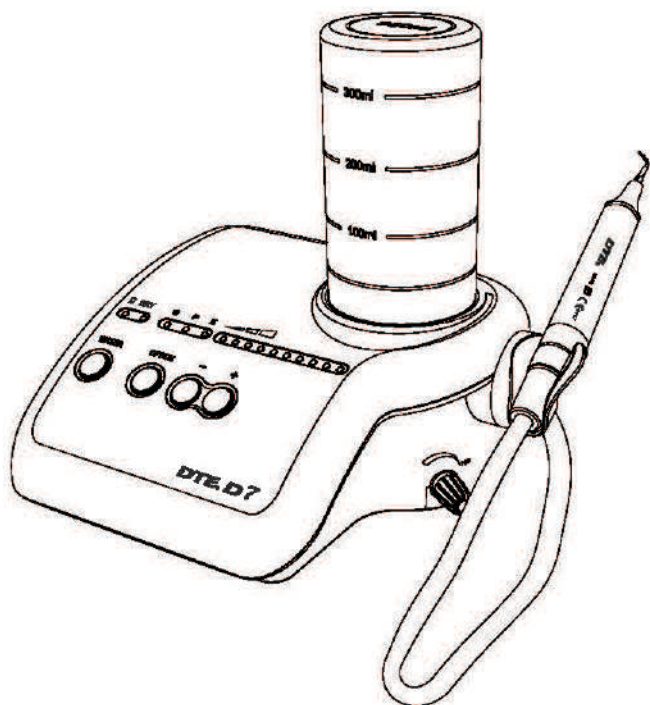

FDA CE 0197

www.glwoodpecker.com

GUILIN WOODPECKER MEDICAL INSTRUMENT CO., LTD.

Contents

1 The installation and components of equipment.....	1
1.1 Instruction.....	1
1.2 Components.....	1
1.3 The main technical specifications.....	1
1.4 Installation of the main components.....	2
2 Product function and operation.....	6
2.1 Scaling function.....	6
2.2 Auto-water supply function.....	8
2.3 Endo function.....	9
3 Sterilization and maintenance.....	10
3.1 Sterilization of detachable handpiece.....	10
3.2 Sterilization of scaling tips and endochuck.....	10
3.3 Sterilization of torque wrench and endo wrench.....	11
3.4 Cleaning of tips, endochuck, torque wrench and endo wrench.....	11
3.5 Troubleshooting and notes.....	11
4 Precaution.....	13
4.1 Notice when using equipment.....	13
4.2 Contraindication.....	14
4.3 Storage and maintenance.....	14
4.4 Transportation.....	14
4.5 Working condition.....	15
5 After service.....	15
6 Symbol instruction.....	15
7 Environmental protection.....	16
8 Manufacturer's right.....	16
9 For technical data, please contact.....	16
10 Declaration of conformity.....	17
11 Statement.....	20

1 The installation and components of equipment

1.1 Instruction

Guilin Woodpecker Medical Instrument Co., Ltd. is a professional manufacturer in researching, developing and producing ultrasonic scalers. The product is mainly used for teeth cleaning and also an indispensable equipment for teeth disease prevention and treatment. The new product D7 ultrasonic scaler has scaling, perio, endo and auto-water supply functions with the following features:

1.1.1 With auto-water supply function, easier operation.

1.1.2 The inner water pipe is made from antiseptic material, clinical fluids, such as Hydrogen peroxide, chlorhexidine and sodium Hypochlorite, etc, can be used perfectly under the mode of auto-water supply system so that the performance of perio and endo is improved dramatically.

1.1.3 The handpiece is detachable and can be autoclaved to the temperature of 135°C and the pressure of 0.22MPa.

1.1.4 Automatic frequency tracking ensures that the machine always works on the best frequency and performs more steadily.

1.1.5 Controlled by PC, easy operation and more efficient for scaling.

These features make D7 become a new generation product in the world dental market.

1.2 Components

1.2.1 The components of machine are listed in the packing list.

1.2.2 Product performance and structure

Ultrasonic scaler is composed of electrocircuit, water way and ultrasonic transducer.

1.2.3 Scope of application

Ultrasonic scaler D7 is used for the dental calculus elimination and root canal treatment.

1.3 The main technical specifications

1.3.1 Power supply Input: 220-240V~ 50Hz/60Hz 150mA

- 1.3.2 Main unit input: 24V~ 1.3A
- 1.3.3 Output primary tip vibration excursion: $\leq 100\mu\text{m}$
- 1.3.4 Output half-excursion force: $< 2\text{N}$
- 1.3.5 Output tip vibration frequency: $28\text{kHz} \pm 3\text{kHz}$
- 1.3.6 Output power: 3W to 20W
- 1.3.7 Main unit fuse: T1.6AL 250V
- 1.3.8 Power supply fuse: T0.5AL 250V
- 1.3.9 Weight of main unit: 1.17kg
- 1.3.10 Weight of power supply: 1 kg
- 1.3.11 Operating mode: Continuous operation
- 1.3.12 Type of protection against electric shock: Class II equipment
- 1.3.13 Degree of protection against electric shock: Type BF applied part
- 1.3.14 Degree of protection against harmful ingress of water: Ordinary equipment
- 1.3.15 Protection degree against water (used on the foot switch): IPX1
- 1.3.16 Applied part of the equipment: handpiece and tip
- 1.3.17 Degree of safety of application in the presence of a Flammable Anaesthetic Mixture with air or with Oxygen or Nitrous Oxide: Equipment not suitable for being used in the presence of a flammable anaesthetic mixture with air or with oxygen or nitrous oxide.

1.4 Installation of the main components

Sketch map for installation and connection.

- 1.4.1 The front and back sketch map of the main unit

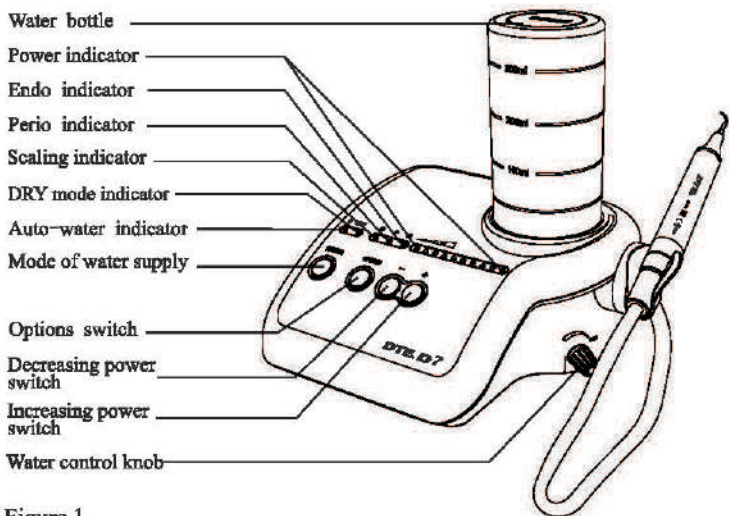

Figure 1

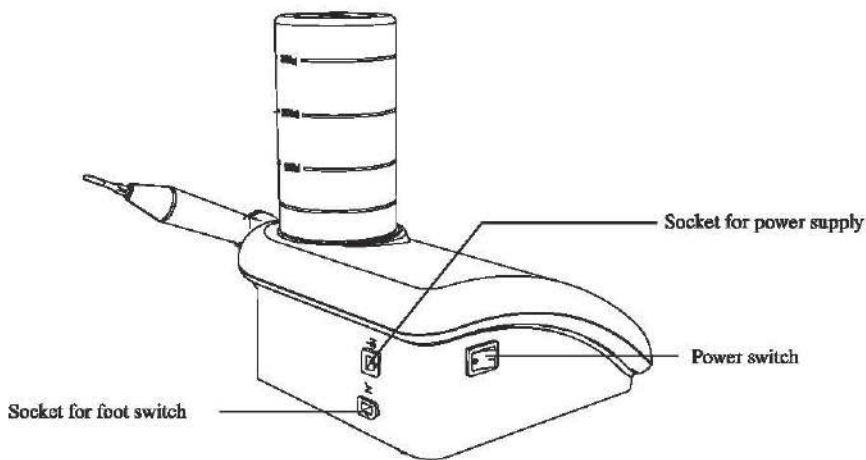

Figure 2

1.4.2 Sketch map for connection of foot switch, power supply and main unit.

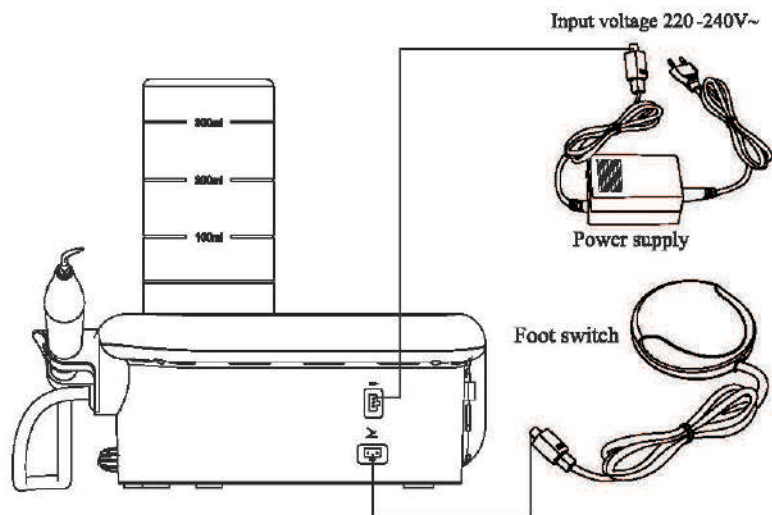

Figure 3

1.4.3 Water way connection

Sketch map for water bottle installation

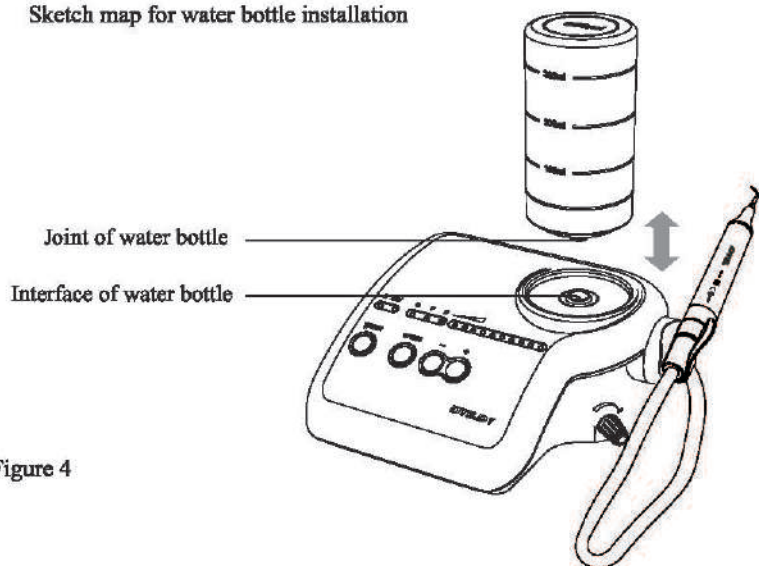

Figure 4

1.4.4 Sketch map for connection of detachable handpiece

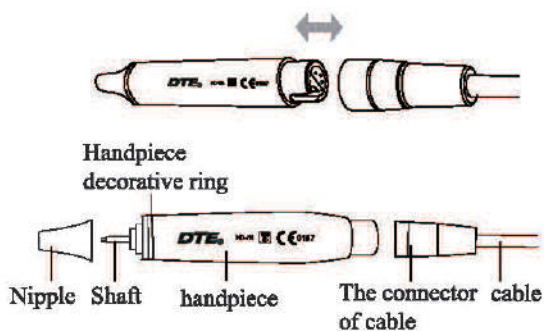

Figure 5

1.4.5 Sketch map for how to install tip and endochuck with wrench

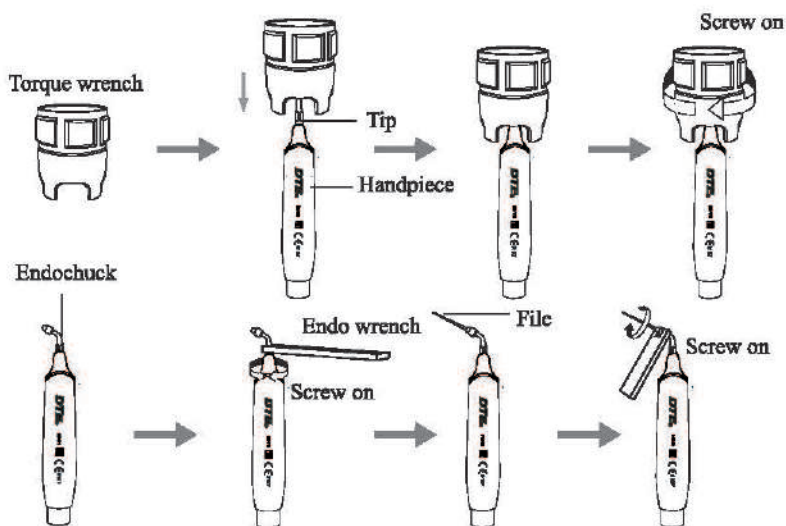

Figure 6

2 Product function and operation

2.1 Scaling function

2.1.1 Operation

- a) Open the packing box, make sure that all the parts and accessories are complete according to the packing list. Take the main unit out of the box and put it on a stable plane.
- b) Turn the water control knob to the max based on symbol as shown in 3.5.2 [note 1].
- c) Insert the plug of the foot switch to its socket (See Figure 3).
- d) Water way installation:
Install the bottle reversely to the connector with adequate purified water (See Figure 4).
- e) Screw the scaling tip tightly to the handpiece by torque wrench, then connect the handpiece and the connector of cable correctly.
- f) Insert the plug of the power supply to its socket , then get through to the power.
- g) Switch on the main unit, then the scaling indicator and the first five power indicators shine, auto-water indicator is on.
- h) According to need, press water button to choose auto-water or DRY mode. The indicator of choosen mode is on.
- i) Select a suitable scaling tip as you need, screw it on the handpiece tightly by the torque wrench (See Figure 6).
- j) Step on the foot switch, the tip begins to vibrate.
- k) The normal frequency is extremely high. Under the normal working state of the scaling tip, a light touch and a certain to-and-fro motion will eliminate the tartar without heating. Overexertion and long-time lingering are forbidden.
- l) Vibration intensity: Adjust the vibration intensity as you need, generally increase the power by pressing the Increasing Power Switch to a higher grade. According to patient's different sensitivity and the rigidity of the gingival tartar, adjust the vibration intensity during the clinical treatment.
- m) Water volume adjust: Step on the foot switch, and the tip begins to

vibrate, then turn the water control knob to form fine spray to cool down the handpiece and clean the teeth.

- n) The handpiece can be handled in the same gesture as a pen in hand.
- o) During the clinical treatment, be sure not to make the end of tip touch the teeth vertically and not to make the tip overexert on the surface of the teeth in case of hurting the teeth and damaging the tip.
- p) After finishing operation, keep the machine working for 30 seconds on the water supply condition in order to clean the handpiece and the scaling tip.
- q) Unscrew the scaling tip and pull out handpiece, then sterilize them.

Notice:

- ① **Don't pull out the handpiece when the foot switch is stepped on and the machine is producing ultrasonic vibration.**
- ② **Please don't choose dry mode unless needed in the treatment, please don't make the machine work under dry mode for a long time. The teeth will be hurt if the handpiece and tips getting overheat during the treatment.**

2.1.2 Instruction for main components of detachable handpiece (See Figure 5):

- a) Nipple: The nipple can be removed. You can screw out the nipple and clean the pole with alcohol termly.
- b) Decorative ring: can be disassembled and cleaned with alcohol regularly, can be autoclaved under the high temperature and pressure.
- c) Handpiece: The main part of the whole handpiece, can be autoclaved under the high temperature and pressure.
- d) The connector of the cable: Connect the handpiece with the water source and power supply of the main unit.

Notice: Keep dry when the detachable handpiece connects to the connector of the cable.

2.1.3 Instruction of torque wrench (See Figure 6)

- a) The torque wrench's structure is designed in special way which can control the strength of the scaling tip's installation properly and correctly. It also can

guarantee the operator screw or unscrew the scaling tip effectively and keep their hands away from being scratched.

b) Operation

- ① Take the scaling tip into the torque wrench, operate as showed in figure 6.
- ② Tip installation: Hold the handpiece, turn the tip toward direction as showed in figure 6 with the torque wrench. Turn one more circles when the tip stops, then the tip is installed.
- ③ Tip uninstallation: Hold the handpiece, turn the wrench toward anti-clockwise direction.
- ④ Sterilize it in sterilizer after each treatment.
- ⑤ The torque wrench must be cooled naturally after sterilization to avoid scald when using next time.
- ⑥ Keep the torque wrench in a cool, dry and ventilated place and keep it clean.

2.2 Auto-water supply function

2.2.1 Usage process

- a) Pull out the water bottle vertically.
- b) Open the lid, fill the bottle with adequate purified water and tighten the lid.
- c) Clean the joint and interface of water bottle.
- d) Place the bottle with water upside down, insert the joint into the interface vertically (See Figure 4).
- e) Press "WATER" to choose auto-water supply.

2.2.2 Notice

- a) Make sure the air hole and water entrance are unblocked (See Figure 7).

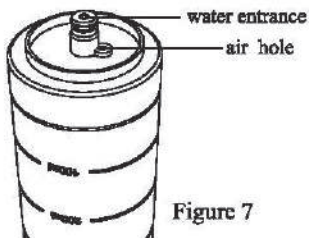

Figure 7



Figure 8

- b) Check if the cushion inside the lid is on good condition. If it becomes deformed or falls off, reinstall or change it.
- c) Tighten the lid.
- d) Clean the joint and interface of water bottle before each clinical operation.
- e) After each clinical operation with clinical liquid, change a bottle with purified water, turn the water supply to max, make the machine work with auto-water supply for 30 seconds in order to keep the water way and spare parts clean and durable.
- f) When the water is lower than water level lower limit, please add water (See Figure 8).

2.3 Endo function

2.3.1 Usage process

- a) Fix endochuck to handpiece by endo wrench (See Figure 6).
- b) Unscrew the screw cap on the endochuck.
- c) Put the ultrasonic file into the hole in the front of endochuck.
- d) Screw the screw cap with endo wrench to tight up the ultrasonic file.
- e) Press option key, turn to endo function.
- f) When ultrasonic scaler turns into endo function, only the first power indicator is on and the power is at the 1st grade. Put the ultrasonic file into the patient's root canal slowly, step on the foot switch to start endo treatment. During the treatment, turn up the power gradually according to the needs.

2.3.2 Notice

- a) When fixing endochuck, it must be screwed down.
- b) The screw cap on the endochuck must be screwed down.
- c) Don't press it too much when the ultrasonic file in root canal.
- d) Don't step on the foot switch until the ultrasonic file is in root canal.
- e) The power range of endo treatment is advised from the 1st to the 5th grade.

3 Sterilization and maintenance

3.1 Sterilization of detachable handpiece

3.1.1 Autoclaved under high temperature/pressure:

- a) 121 °C/lbar (0.1MPa).
- b) 135 °C/2.2bar (0.22MPa).
- c) Pull out the handpiece and unscrew the scaling tip and endochuck after each operation.
- d) Pack the handpiece with sterile gauze or sterile bag before sterilizing.
- e) Reuse handpiece after it cools naturally to avoid scalding hands.

3.1.2 Notice

- a) Dry the cleaning liquid in the handpiece with compressed air before sterilization.
- b) Be sure that the scaling tip has been unscrewed from the handpiece and it cannot be sterilized with others.
- c) Please notice whether the outer of the handpiece is damaged during the treatment or sterilization, don't smear any protective oil on the surface of handpiece.
- d) There are two waterproof "o" rings at the end of handpiece. Please lubricate them with dental lube frequently, as sterilization and repeated pulling and inserting will reduce their working life. Change a new one once it is damaged or worn excessively.
- e) The following sterilizing methods are forbidden:
 - ① Put handpiece into any liquid for boiling.
 - ② Dip handpiece in disinfectors such as iodine, alcohol and glutaraldehyde.
 - ③ Put handpiece into oven or microwave oven for baking.

3.2 Sterilization of scaling tips and endochuck

All the scaling tips and endochuck can be autoclaved under high temperature and pressure.

3.3 Sterilization of torque wrench and endo wrench

3.3.1 The torque wrench and endo wrench can be sterilized under high temperature and pressure.

3.3.2 The following sterilization ways for torque wrench are forbidden.

- a) Braise in liquor.
- b) Dip in iodine, alcohol or glutaraldehyde.
- c) Torrefy in oven or microwave oven.

Notice: We are not responsible for any damage of the torque wrench directly or indirectly made by any way in the above items.

3.4 Cleaning of tips, endochuck, torque wrench and endo wrench

The scaling tip, endochuck, torque wrench and endo wrench can be cleaned by ultrasonic cleaner.

3.5 Troubleshooting and notes

3.5.1 Troubleshooting

Fault	Possible cause	Solutions
The scaling tip doesn't vibrate and there is no water flowing out when stepping on the foot switch.	The power plug is in loose contact.	Make the plug insert to the socket well.
	The foot switch is in loose contact.	Insert the foot switch to its socket tightly.
	The fuse in the main unit is broken.	Contact our dealers or us.
The scaling tip doesn't vibrate but there is water flowing out when stepping on the switch.	The tip is in loose contact.	Contact our dealers or us.
	The connect plug between the handpiece and the circuit board is in loose contact.	Contact our dealers or us.
	Something wrong with the handpiece.	Send the handpiece to our company to repair.
	Something wrong with the cable.	Contact our dealers or us.

Fault	Possible cause	Solutions
The scaling tip vibrates but there is no spray when stepping on the foot switch.	The water control knob is not on.	Turn on the water control knob [note 1].
The vibration of the tip becomes weak.	The tip hasn't been screwed on to the handpiece tightly.	Screw the tip on the handpiece tightly (See Figure 6).
	The tip is loose because of vibration.	Screw on the tip tightly (See Figure 6).
	The coupling between the handpiece and the cable isn't dry.	Dry it by the hot air.
	The tip is damaged [note 2].	Change a new one.
There is water seeping from the coupling between the handpiece and cable.	The waterproof "O"ring is damaged.	Change a new waterproof "O"ring.
The u-file doesn't vibrate.	The screw is loose.	Tighten it.
	Endochuck is damaged.	Change a new one.
There is noise coming from the endochuck.	The screw is loose.	Tighten it.
There is no water coming out from the handpiece (automatic water supply mode).	There is air in the water pipe.	Turn the water control to the Max, reinsert the bottle.

If the problem still can't be solved, please contact with local dealer or manufacturer.

3.5.2 Notes

[Note 1] Turn the water control knob as symbol showed. It comes to the min, on the contrary direction, it comes to the max.

[Note 2] If the scaling tip has been screwed on tightly and there is fine spray

too, the following phenomena show that the scaling tip is damaged:

- a) The vibrating intensity and the water spray degree become weak obviously.
- b) During treatment, it produces the sound like "buzz" from the scaling tip.

4 Precaution

4.1 Notice when using equipment

- 4.1.1 Keep the scaler clean before and after operation.
- 4.1.2 The handpiece, scaling tip, torque wrench, endo wrench and endochuck must be sterilized before each treatment.
- 4.1.3 Don't screw or unscrew the scaling tip and endochuck when stepping on the foot switch.
- 4.1.4 The scaling tip must be fastened and there must be fine spray or drip coming out from the tip when operating.
- 4.1.5 Change a new one when the tip and ultrasonic file are damaged or worn excessively.
- 4.1.6 While scaler working ,the heat of scaling tip will become higher if there is no water flowing out.Please keep the water flow smoothly.
- 4.1.7 Don't twist or rub the tip and endochuck.
- 4.1.8 Ensure the connector of handpiece and the socket of the cable dry before installing the handpiece.
- 4.1.9 Don't pull the cable forcibly in case of the handpiece falling off from the cable.
- 4.1.10 Don't knock or rub the handpiece.
- 4.1.11 Please put the power plug into the socket easy to pull out, to make sure it can be pull out in emergency.
- 4.1.12 The power supply is considered as a part of ME equipment.This device can only be equipped with the special power supply of Guilin Woodpecker Medical Instrument Co., Ltd.
- 4.1.13 The power supply is NOT waterproof. Please keep it dry and away from the water.
- 4.1.14 After operation, turn off power, and pull out the plug.

4.1.15 We are only responsible for the safety on the following conditions:

I. The maintenance, repair and modification are made by the manufacturer or the authorized dealer.

II. The changed components are original of "DTE" and are operated according to instruction manual.

4.1.16 The internal screw thread of the scaling tips produced by some manufacturers maybe coarse, rusty and collapsed. This will damage the external screw thread of the handpiece irretrievably. Please use "DTE" brand scaling tips.

4.1.17 This model is only matched the power supply of our company.

4.1.18 Please select a suitable power when using different type of tips (refer to "TABLE OF OPERATING POWER OF THE TIPS").

4.2 Contraindication

4.2.1 The hemophilia disease patient is not allowed to use this equipment.

4.2.2 The patients or doctors with heart pacemaker are forbidden to use this equipment.

4.2.3 The heart disease patient, pregnant woman and children should be cautious to use the equipment.

4.3 Storage and maintenance

4.3.1 The equipment should be handled carefully and lightly. Be sure that it is far from the vibration, and installed or kept in a cool, dry and ventilated place.

4.3.2 Don't store the machine together with the articles that are combustible, poisonous, caustic, and explosive.

4.3.3 This equipment should be stored in a room where the relative humidity is $\leq 80\%$, atmospheric pressure is 50kPa to 106kPa, and the temperature is -10°C to $+50^{\circ}\text{C}$.

4.3.4 If not use for a long time, please make the machine get through to the power and water once per month for five minutes.

4.4 Transportation

4.4.1 Excessive impact and shake should be prevented in transportation. Lay

it carefully and lightly and don't invert it.

4.4.2 Don't put it together with dangerous goods during transportation.

4.4.3 Avoid solarization and getting wet in rain or snow during transportation.

4.5 Working condition

Environment temperature: +5°C to +40°C

Relative humidity: ≤80%

Atmosphere pressure: 70kPa to 106kPa

5 After service

We offer one year free repair to the equipment according to the warranty card.

The repair of the equipment should be carried out by our professional technician.

We are not responsible for any irretrievable damage caused by the not professional person.

6 Symbol Instruction

DTE.

Trademark



Used indoor only



Consult the accompanying documents



Appliance compliance WEEE directive



Caution



Alternating current



Date of manufacture



Manufacturer



Class II equipment



Type BF applied part



Connection for the foot switch



IPX1 Anti-drip device

~24V

24VAC power supply socket



Add water



Adjustment for the water flow



Mode of auto-water system

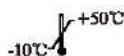

Temperature limitation



Humidity limitation

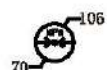

Atmospheric pressure
for working

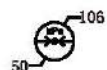

Atmospheric pressure
for storage



Can be autoclaved



CE marked product



FDA marked product



Handle with care



Recovery



Keep dry



Authorised Representative in the EUROPEAN COMMUNITY

7. Environmental protection

The device does not contain any harmful ingredients. You can deal with it based on the local law.

8. Manufacturer's right

We reserve the rights to change the design of the equipment, the technique, fittings, the instruction manual and the content of the original packing list at any time without notice. If there are some differences between blueprint and real equipment, take the real equipment as the norm.

9. For technical data, please contact



Wellkang Ltd (www.CE-Marking.eu)
29 Harley St., LONDON, W1G 9QR, UK

10. Declaration of conformity

10.1 Product conforms to the following standards

EN 60601-1:2006	EN 60601-1-2:2007
EN 60601-1-6:2010	EN 62366:2008
EN 61205:1994	EN ISO 22374:2005
EN 62304:2006	EN 980:2008
EN ISO 9687:1995	EN 1041:2008
ISO 15223-1:2012	EN ISO 14971:2012
EN ISO 7405:2008 +A1:2003	EN ISO 17664:2004
EN ISO 17665-1:2006	EN ISO 10993-1:2009
EN ISO 10993-5:2009	EN ISO 10993-10:2010

10.2 EMC-Declaration of conformity

Guidance and manufacturer's declaration - electromagnetic emissions		
The model UDS-J, UDS-K, UDS-K LED, UDS-L, UDS-L LED, UDS-A, UDS-A LED, UDS-P, UDS-E, UDS-P LED, UDS-E LED, D1, D3, D5, D7, D3 LED, D5 LED, D7 LED are intended for use in the electromagnetic environment specified below. The customer or the user of the model UDS-J, UDS-K, UDS-K LED, UDS-L, UDS-L LED, UDS-A, UDS-A LED, UDS-P, UDS-E, UDS-P LED, UDS-E LED, D1, D3, D5, D7, D3 LED, D5 LED, D7 LED should assure that it is used in such an environment.		
Emissions test	Compliance	Electromagnetic environment - guidance
RF emissions CISPR 11	Group 1	The models UDS-J, UDS-K, UDS-K LED, UDS-L, UDS-L LED, UDS-A, UDS-A LED, UDS-P, UDS-E, UDS-P LED, UDS-E LED, D1, D3, D5, D7, D3 LED, D5 LED, D7 LED use RF energy only for its internal function. Therefore, its RF emissions are very low and are not likely to cause any interference in nearby electronic equipment.
RF emissions CISPR11	Class B	The models UDS-J, UDS-K, UDS-K LED, UDS-L, UDS-L LED, UDS-A, UDS-A LED, UDS-P, UDS-E, UDS-P LED, UDS-E LED, D1, D3, D5, D7, D3 LED, D5 LED, D7 LED are suitable for used in domestic establishment and in establishment directly connected to a low voltage power supply network which supplies buildings used for domestic purposes.
Harmonic emissions IEC 81000-3-2	Class A	
Voltage fluctuations / flicker emissions IEC 81000-3-3	Complies	

Guidance & Declaration — electromagnetic immunity			
The models UDS-J, UDS-K, UDS-K LED, UDS-L, UDS-L LED, UDS-A, UDS-A LED, UDS-P, UDS-E, UDS-P LED, UDS-E LED, D1, D3, D5, D7, D3 LED, D5 LED, D7 LED are intended for use in the electromagnetic environment specified below. The customer or the user of the models UDS-J, UDS-K, UDS-K LED, UDS-L, UDS-L LED, UDS-A, UDS-A LED, UDS-P, UDS-E, UDS-P LED, UDS-E LED, D1, D3, D5, D7, D3 LED, D5 LED, D7 LED should assure that it is used in such an environment.			
Immunity test	IEC 60601 test level	Compliance level	Electromagnetic environment - guidance
Electrostatic discharge (ESD) IEC 61000-4-2	±8 kV contact ±8 kV air	±8 kV contact ±8 kV air	Floors should be wood, concrete or ceramic tile. If floors are covered with synthetic material, the relative humidity should be at least 30 %.
Electrical fast transient/burst IEC 61000-4-4	±2kV for power supply lines ±1 kV for input/output lines	±2kV for power supply lines ±1kV for Interconnecting cable	Mains power quality should be that of a typical commercial or hospital environment.
Surge IEC 61000-4-5	±1 kV line to line ±2 kV line to earth	±1 kV line to line	Mains power quality should be that of a typical commercial or hospital environment.
Voltage dips, short interruptions and voltage variations on power supply input lines IEC 61000-4-11.	<5 % U_T (>95% dip in U_T) for 0.5 cycle 40 % U_T (80% dip in U_T) for 5 cycles 70% U_T (30% dip in U_T) for 25 cycles <5% U_T (>85 % dip in U_T) for 5 sec	<5 % U_T (>95% dip in U_T) for 0.5 cycle 40 % U_T (80% dip in U_T) for 5 cycles 70% U_T (30% dip in U_T) for 25 cycles <5% U_T (>85 % dip in U_T) for 5 sec	Mains power quality should be that of a typical commercial or hospital environment. If the user of the models UDS-J, UDS-K, UDS-K LED, UDS-L, UDS-L LED, UDS-A, UDS-A LED, UDS-P, UDS-E, UDS-P LED, UDS-E LED, D1, D3, D5, D7, D3 LED, D5 LED, D7 LED require continued operation during power mains interruptions, it is recommended that the models UDS-J, UDS-K, UDS-K LED, UDS-L, UDS-L LED, UDS-A, UDS-A LED, UDS-P, UDS-E, UDS-P LED, UDS-E LED, D1, D3, D5, D7, D3 LED, D5 LED, D7 LED be powered from an uninterruptible power supply or a battery.
Power frequency (50/60 Hz) magnetic field IEC 61000-4-8	3 A/m	3 A/m	Power frequency magnetic fields should be at levels characteristic of a typical location in a typical commercial or hospital environment.
NOTE U_T is the a.c. mains voltage prior to application of the test level.			

Guidance & Declaration - Electromagnetic Immunity			
The models UDS-J, UDS-K, UDS-K LED, UDS-L, UDS-L LED, UDS-A, UDS-A LED, UDS-P, UDS-E, UDS-P LED, UDS-E LED, D1, D3, D5, D7, D3 LED, D5 LED, D7 LED are intended for use in the electromagnetic environment specified below. The customer or the user of the models UDS-J, UDS-K, UDS-K LED, UDS-L, UDS-L LED, UDS-A, UDS-A LED, UDS-P, UDS-E, UDS-P LED, UDS-E LED, D1, D3, D5, D7, D3 LED, D5 LED, D7 LED should assure that it is used in such an environment.			
Immunity test	IEC 60601 test level	Compliance level	Electromagnetic environment - guidance
Conducted RF IEC 61000-4-6 Radiated RF IEC 61000-4-3	3 Vrms 150 kHz to 80 MHz 3 V/m 80 MHz to 2.5 GHz	3V 3 V/m	<p>Portable and mobile RF communications equipment should be used no closer to any part of the models UDS-J, UDS-K, UDS-K LED, UDS-L, UDS-L LED, UDS-A, UDS-A LED, UDS-P, UDS-E, UDS-P LED, UDS-E LED, D1, D3, D5, D7, D3 LED, D5 LED, D7 LED, including cables, than the recommended separation distance calculated from the equation applicable to the frequency of the transmitter.</p> <p>Recommended separation distance</p> <p>3V</p> <p>$d=1.2 \times P^{1/2}$ 80 MHz to 800 MHz</p> <p>$d=2.3 \times P$ 800 MHz to 2.5 GHz</p> <p>where P is the maximum output power rating of the transmitter in watts (W) according to the transmitter manufacturer and d is the recommended separation distance in meters (m).</p> <p>Field strengths from fixed RF transmitters, as determined by an electromagnetic site survey,^a should be less than the compliance level in each frequency range.^b</p> <p>Interference may occur in the vicinity of equipment marked with the following symbol:</p> 
NOTE 1 At 80 MHz and 800 MHz, the higher frequency range applies.			
NOTE 2 These guidelines may not apply in all situations. Electromagnetic propagation is affected by absorption and reflection from structures, objects and people.			
^a Field strengths from fixed transmitters, such as base stations for radio (cellular/cordless) telephones and land mobile radios, amateur radio, AM and FM radio broadcast and TV broadcast cannot be predicted theoretically with accuracy. To assess the electromagnetic environment due to fixed RF transmitters, an electromagnetic site survey should be considered. If the measured field strength in the location in which the models UDS-J, UDS-K, UDS-K LED, UDS-L, UDS-L LED, UDS-A, UDS-A LED, UDS-P, UDS-E, UDS-P LED, UDS-E LED, D1, D3, D5, D7, D3 LED, D5 LED, D7 LED are used exceeds the applicable RF compliance level above, the model UDS-J, UDS-K, UDS-K LED, UDS-L, UDS-L LED, UDS-A, UDS-A LED, UDS-P, UDS-E, UDS-P LED, UDS-E LED, D1, D3, D5, D7, D3 LED, D5 LED, D7 LED should be observed to verify normal operation. If abnormal performance is observed, additional measures may be necessary, such as reorienting or relocating the models UDS-J, UDS-K, UDS-K LED, UDS-L, UDS-L LED, UDS-A, UDS-A LED, UDS-P, UDS-E, UDS-P LED, UDS-E LED, D1, D3, D5, D7, D3 LED, D5 LED, D7 LED.			
^b Over the frequency range 150 kHz to 80 MHz, field strengths should be less than 3V/m.			

Recommended separation distances between portable and mobile RF communications equipment and the models UDS-J, UDS-K, UDS-K LED, UDS-L, UDS-L LED, UDS-A, UDS-A LED, UDS-P, UDS-E, UDS-P LED, UDS-E LED, D1, D3, D5, D7, D3 LED, D5 LED, D7 LED

The model UDS-J, UDS-K, UDS-K LED, UDS-L, UDS-L LED, UDS-A, UDS-A LED, UDS-P, UDS-E, UDS-P LED, UDS-E LED, D1, D3, D5, D7, D3 LED, D5 LED, D7 LED is intended for use in electromagnetic environment in which radiated RF disturbances is controlled. The customer or the user of the models UDS-J, UDS-K, UDS-K LED, UDS-L, UDS-L LED, UDS-A, UDS-A LED, UDS-P, UDS-E, UDS-P LED, UDS-E LED, D1, D3, D5, D7, D3 LED, D5 LED, D7 LED can help prevent electromagnetic interference by maintaining a minimum distance between portable and mobile RF communications equipment (transmitters) and the models UDS-J, UDS-K, UDS-K LED, UDS-L, UDS-L LED, UDS-A, UDS-A LED, UDS-P, UDS-E, UDS-P LED, UDS-E LED, D1, D3, D5, D7, D3 LED, D5 LED, D7 LED are recommended below, according to the maximum output power of the communications equipment.

Rated maximum output power of transmitter W	Separation distance according to frequency f m		
	150kHz to 80MHz $d=1.2 \times P^{1/2}$	80MHz to 800MHz $d=1.2 \times P^{1/2}$	800MHz to 2.5GHz $d=2.3 \times P^{1/2}$
0.01	0.12	0.12	0.23
0.1	0.38	0.38	0.73
1	1.2	1.2	2.3
10	3.8	3.8	7.3
100	12	12	23

For transmitters rated at a maximum output power not listed above, the recommended separation distance d in meters (m) can be estimated using the equation applicable to the frequency of the transmitter, where P is the maximum output power rating of the transmitter in watts (W) accordable to the transmitter manufacturer.

NOTE 1 At 80 MHz and 800 MHz, the separation distance for the higher frequency range applies.

NOTE 2 These guidelines may not apply in all situations. Electromagnetic propagation is affected by absorption and reflection from structures, objects and people.

The device has been tested and homologated in accordance with EN 60601-1-2 for EMC. This does not guarantee in any way that this device will not be effected by electromagnetic interference. Avoid using the device in high electromagnetic environment.

11. Statement

All rights of modifying the product are reserved to the manufacturer without further notice. The pictures are only for reference. The final interpretation rights belong to GUILIN WOODPECKER MEDICAL INSTRUMENT CO., LTD. The industrial design, inner structure, etc, have claimed for several patents by WOODPECKER, any copy or fake product must take legal responsibilities.

TABLE OF OPERATING POWER OF THE TIPS

Tip Model	Scaler Model Power	D5 (LED)	D2 LED	D3 (LED)	D1	V3 (LED)	V1	Compatible Scaler Brand
		D6 (LED)	D2 (LED) Plus			V2 (LED)	V2 (LED)	
Scaling								
GD1		1-10 (G)	1-11	1-10 (G)	1-9	LOW-HIGH	LOW-HIGH	Compatible with DTE & Satelec Ultrasonic Scalers
GD2		1-10 (G)	1-11	1-10 (G)	1-9	LOW-HIGH	LOW-HIGH	
GD3		1-10 (G)	1-11	1-10 (G)	1-9	LOW-HIGH	LOW-HIGH	
GD4		1-10 (G)	1-11	1-10 (G)	1-9	LOW-HIGH	LOW-HIGH	
GD5		1-10 (G)	1-11	1-10 (G)	1-9	LOW-HIGH	LOW-HIGH	
GD6		1-10 (G)	1-11	1-10 (G)	1-9	LOW-HIGH	LOW-HIGH	
GD7		1-10 (G)	1-11	1-10 (G)	1-9	LOW-HIGH	LOW-HIGH	
GD8		1-10 (G)	1-11	1-10 (G)	1-9	LOW-HIGH	LOW-HIGH	
GD9		1-10 (G)	1-11	1-10 (G)	1-9	LOW-HIGH	LOW-HIGH	
GD10		1-10 (G)	1-11	1-10 (G)	1-9	LOW-HIGH	LOW-HIGH	
GD11		1-10 (G)	1-11	1-10 (G)	1-9	LOW-HIGH	LOW-HIGH	
Periodontics								
PD1		1-10 (P)	1-8	1-10 (P)	1-6	LOW-MID	LOW-MID	Compatible with DTE & Satelec Ultrasonic Scalers
PD2L		1-3 (P)	1-3	1-3 (P)	1-2	LOW	LOW	
PD2LD		1-2 (P)	1-2	1-2 (P)	1	LOW	LOW	
PD2R		1-3 (P)	1-3	1-3 (P)	1-2	LOW	LOW	
PD2RD		1-2 (P)	1-2	1-2 (P)	1	LOW	LOW	
PD3		1-6 (P)	1-5	1-6 (P)	1-3	LOW-MID	LOW-MID	
PD3D		1-6 (P)	1-5	1-6 (P)	1-3	LOW-MID	LOW-MID	
PD4		1-6 (P)	1-5	1-6 (P)	1-3	LOW-MID	LOW-MID	
Endodontics								
ED1		1-3 (E)	—	—	—	LOW	—	Compatible with DTE & Satelec Ultrasonic Scalers
ED2		1-3 (E)	—	—	—	LOW	—	
ED3		1-6 (E)	—	—	—	LOW	—	
ED3D		1-3 (E)	—	—	—	LOW	—	
ED4		1-6 (E)	—	—	—	LOW	—	
ED4D		1-3 (E)	—	—	—	LOW	—	
ED5		1-6 (E)	—	—	—	LOW	—	
ED5D		1-3 (E)	—	—	—	LOW	—	
PD4D		1-6 (E)	—	—	—	LOW	—	
ED6		1-10 (E)	—	—	—	LOW	—	
ED9		1-10 (E)	—	—	—	LOW	—	
ED10		1-6 (E)	—	—	—	LOW	—	
ED10D		1-6 (E)	—	—	—	LOW	—	
ED11		1-6 (E)	—	—	—	LOW	—	
ED11D		1-6 (E)	—	—	—	LOW	—	
ED14		1-3 (E)	—	—	—	LOW	—	
ED15		1-3 (E)	—	—	—	LOW	—	
Cavity Preparation								
SBD1		1-10 (P)	1-8	1-10 (P)	1-6	LOW-MID	LOW-MID	Compatible with DTE & Satelec Ultrasonic Scalers
SBD2		1-10 (P)	1-8	1-10 (P)	1-6	LOW-MID	LOW-MID	
SBD3		1-10 (P)	1-8	1-10 (P)	1-6	LOW-MID	LOW-MID	
SBDL		1-10 (P)	1-8	1-10 (P)	1-6	LOW-MID	LOW-MID	
SBDRL		1-10 (P)	1-8	1-10 (P)	1-6	LOW-MID	LOW-MID	

(NOTE) : 'G' for the working mode of 'Scaling'; 'P' for the working mode of 'Periodontics'; 'E' for the working mode of 'Endodontics'; '—' for 'not suitable for such model of scaler'.

Scan and Login website
for more information



Guilin Woodpecker Medical Instrument Co., Ltd.
Information Industrial Park, National High-Tech
Zone, Guilin, Guangxi, 541004 P. R. China

Tel:

Europe Sales Dept.: +86-773-5873196, +86-773-2125222

North America, South America &

Oceania Sales Dept.: +86-773-5873198, +86-773-2125123

Asia & Africa Sales Dept.: +86-773-5855350, +86-773-2125896

Fax: +86-773-5822450

E-mail: woodpecker@glwoodpecker.com sales@glwoodpecker.com

Website: <http://www.glwoodpecker.com>



Wellkang Ltd (www.CE-Marking.eu)
29 Harley St., LONDON, W1G 9QR, UK

ZMN/WI-09-059 INS-US-D7-ED-V2.9