

US-II and US-II LED

MANUAL OF USE AND MAINTENANCE



Guilin Woodpecker Medical Instrument Co., Ltd.

Please read this manual before operating

Content

1. Introduction	1
2. Identification data	5
3. Testing of the device	7
4. Delivery	7
5. List of material included in the supply	7
6. Installation	9
7. Controls	13
8. Cleaning, Disinfection and Sterilization	19
9. Regular maintenance	25
10. Replacement of the fuses	26
11. Disposal procedures and precautions	27
12. Tips	27
13. Symbols	28
14. Troubleshooting	29
15. Technical data	31
16. After service	33
17. Environmental protection	33
18. Manufacturer's right	33
19. European authorized representative	33
20. Declaration of conformity- EMC	34
21. Guarantee	36
22. Statement	38

1. Introduction

1.1 Foreword

Before proceeding with the installation, use, maintenance or any other activities on the equipment please read the manual carefully.

Important: To avoid causing personal injuries or damages to property, read all the points concerning “safety requirement” contained in this manual with particular attention.

Depending on the level of risk involved, safety requirements are classed under the following indications:



Danger(always referred to personal injury)



Warning(referred to possible damage to property)

The purpose of this manual is to ensure that operators are aware of the safety requirements, of the installation procedures and of the instructions for correct use and maintenance of the apparatus.

The user is not authorized to tamper with the equipment under any circumstances.

If any problems are encountered, please contact a Woodpecker Service Centre.

Any attempts on the part of the user or any unauthorized personnel to tamper with or alter the apparatus will invalidate the warranty and release the Manufacturers from any liability in respect of any harm or damage to persons or property.

The information and illustration contained in this manual are up-dated to the date of publication indicated on the last page.

WOODPECKER is committed to continuous up-dating of the products, which may entail changes to components of the equipment. If there are any discrepancies between the descriptions contained in this manual and your equipment, please contact your dealer or the WOOKPECKER After-sale service for explanations.

Using this manual for purposes other than those relating to the installation, use and maintenance of the equipment is strictly prohibited.

1.2 Description of the Device

Thanks to its controlled three-dimensional ultrasound oscillations, the original US-II (LED) technique rings in a new age for osteotomy and osteoplasty in Implantology, Periodontology, Endodontics and Orthodontic Surgery. Its main features are:

Micrometric cutting: Maximum surgical precision and intra-operative sensibility;

Selective cutting: Maximum safety for the soft tissues;

Cavitation effect: Maximum intra-operative visibility (bloodless field);

The equipment has an automatic tuning circuit that offsets wear of the tips, thus ensuring work in constant conditions of maximum efficiency.

1.3 Intended Use

The US-II (LED) is a piezoelectric device for bone surgery that enables osteotomy and osteoplasty techniques to be applied to in almost any anatomical situation. This equipment can be used in the following fields:

- a) Oral surgery;
- b) Orthopedic surgery;
- c) Maxillofacial surgery;
- d) Cosmetic surgery;
- e) Neurosurgery;
- f) Otolaryngology.

This equipment cannot function in places where there is an inflammable atmosphere (anaesthetic mixture, oxygen, etc).

1.4 Safety requirements

Woodpecker will not accept any liability for direct or incidental personal injury or damage to property in the following cases:

1.4.1 If the equipment is used for purposes other than that for which it is intended;

1.4.2 If the equipment is not used in accordance with all the instructions and requirements described in this manual;

1.4.3 If the wiring system in the room where the equipment is used does not

comply with the application standard and appropriate requirements;

1.4.4 If any assembly operations, extensions, settings, alterations or repairs have been carried out by personnel not authorized by Woodpecker;

1.4.5 If the environmental conditions in which the device is kept and stored do not comply with the requirements indicated in the chapter on technical specifications.

 **Danger: Qualified and specialized personnel.**

This equipment may be used only by specialized and suitably trained personnel such as surgeons. If correctly used, this equipment does not give rise to side effects. Improper use, on the other hand, will give rise to transmission of heat to the tissues.

 **Danger: Intended use.**

Use the equipment solely for the purpose for which it is intended (see point 1.3), failure to comply with this requirement could lead to serious harm to the patient and/or to the operator and/or damage to/failure of the equipment.

 **Danger: Contraindications.**

Do not use the US-II (LED) on patients with pace-makers or other implantable electronic devices. The same requirement applies also to the operator.

 **Danger: Contraindications.**

An electrosurgical knife could interfere with correct functioning of the device.

 **Danger: Cleaning, disinfection and sterilization of new or repaired products.**

All new or repaired products are delivered in no sterile conditions. Before being used for treatments, all new or repaired products should be cleaned, disinfected and sterilization following the instructions provided under point 8 strictly.

 **Danger: Use only original Woodpecker accessories and spare parts.**

 **Danger: Check the condition of the device before treatment.**

Always make sure that there is no water under the apparatus. Before each treatment always check that the equipment is in proper working order and that the accessories are efficient. Do not carry out the treatment if any problems are encountered in operating the device. If the problems concern the equipment contact an authorized technical service centre.

 **Danger: Breakage and wear of the tips.**

The high-frequency vibrations and wear may, very occasionally, lead to breakage of the tip. Tips of which the shape has been changed or which are otherwise damaged are liable to break during use. Any such tips should definitely not be used. It is necessary to instruct the patient to breathe through his nose during the treatment in order to avoid ingestion of the broken off fragment of the tip.

 **Danger: Do not install this equipment anywhere there is a risk of explosions.**

This equipment cannot function in places where there is an inflammable atmosphere. (anaesthetic mixture, oxygen, etc)

 **Danger: Personnel injury.**

The foot switch of the US-II (LED) must not be activated when the door of the peristaltic pump open. (Fig.5—Ref.B).Moving parts could injure the operator.

 **Danger: Contraindication.**

Do not carry out this treatment on metal or ceramic prosthetic artifacts. The ultrasonic vibrations could lead to decrementing of such artifacts.

 **Danger: Contraindication.**

After autoclave sterilizing of the handpiece, wait for it to cool down completely before using it.

2. Identification data

2.1 Identification data

An exact description of the model including the serial number of the equipment will make it easier for our After-Sale Service to respond quickly and efficiently to your enquiry.

Always provide the above information whenever you contact a Woodpecker Service Centre.

2.2 Data plate of the device

Each device has its own data plate (Fig.1), on which technical specifications and serial number are indicated. The data plate is on the rear of the device. The remaining data are included in this manual (see point 15).

Piezo Bone Surgery

Mode I: US-II

SN  **0197**  IPX1

Input: 100V-240V~ 50Hz/60Hz 120VA

Intermittent operation: Max T_{on} 60s, T_{off} 10s

 Gullin Woodpecker Medical Instrument Co.,Ltd.
Information Industrial Park, Gullin National High-tech Zone,
Gullin, Guangxi, 541004, P.R.China

Website: <http://www.glwoodpecker.com>

 **EC REP** MedNet EC-Rep GmbH
Borkstrasse 10 · 48163 Muenster · Germany







Fig.1

2.3 Data plate of the scaler handpiece

The serial number of the DS-II (LED) handpiece is engraved on the ring nut (Fig.2).



Fig.2

2.4 Data plate of the foot switch

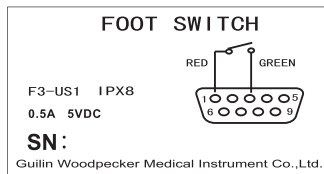

Fig.3

3. Testing of the device

All the devices are checked and tested by Woodpecker completely, including all the parts.

When testing, all the parts will work in intermittent operation.

The test emphasized that all the problems are from the failure parts.

This procedure ensures the function and reliability of all the parts.

4. Delivery

Avoid the excessive concussion, shake, cover in delivery.

Do not mix with the danger articles.

Avoid the sunlight, rain and snow in delivery.

5. List of material included in the supply

The material included in the supply may vary in case of promotional campaigns.



Warning: Handpiece and cord can't be detached.

Name	Quality	Ref
Peristaltic pump	1	Fig.4—Ref.A
Device	1	Fig.4—Ref.B
Torque wrench	1	Fig.4—Ref.C
US-II (LED) handpiece complete with cord	2	Fig.4—Ref.D
Connection for the cord and tube of the peristaltic pump	1	Fig.4—Ref.E
Connector of handpiece	1	Fig.4—Ref.F
Plug of Footswitch	1	Fig.4—Ref.G
Footswitch	1	Fig.4—Ref.H
Tip Holder	Marked on the packing list	Fig.4—Ref.I

Name	Quality	Ref
Tip	Marked on the packing list	Fig.4—Ref.J
Input of power-supply cable	1	Fig.4—Ref.K
Output of power-supply cable	1	Fig.4—Ref.L
Surgical tray	1	Fig.4—Ref.M
Rod for supporting the bag	1	Fig.4—Ref.N
Support for the handpiece	1	Fig.4—Ref.O
Pump tube	1	Fig.4—Ref.P

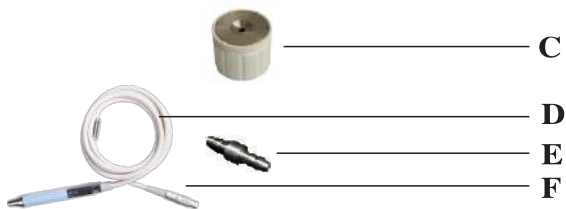
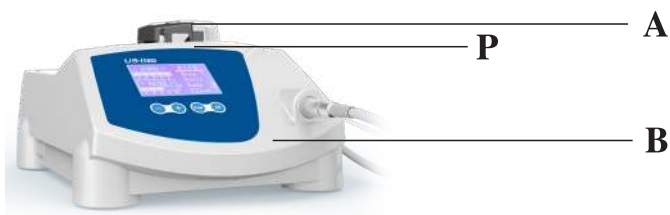

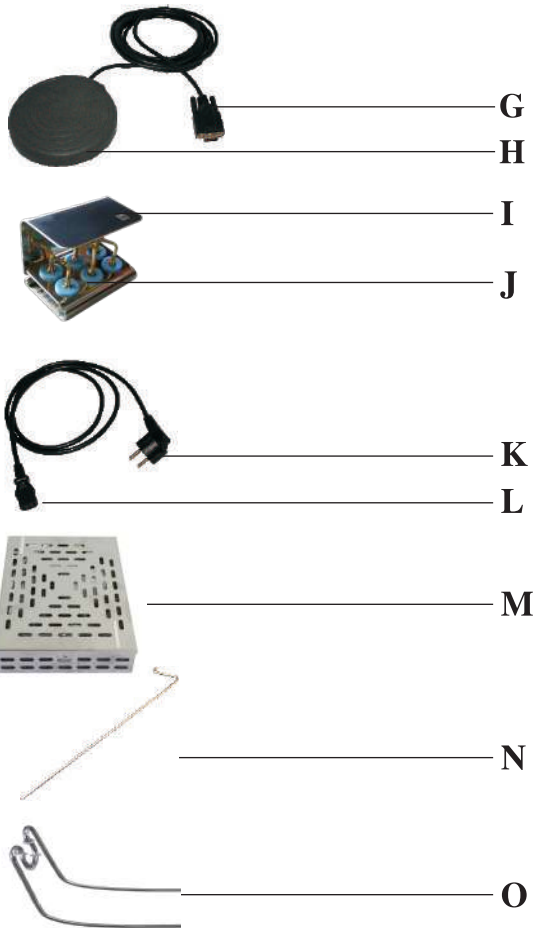

Fig.4

Applied parts : Handpiece , tips .

6. Installation

6.1 Safety requirements during Installation





Danger: The wiring system of the premises where the apparatus

is installed and used must comply with the applicable standards and the relevant electrical safety requirements.

 **Danger:** Do not install the apparatus in places where there is a risk of explosion. The apparatus may not be used in areas where there are inflammable atmospheres (anaesthetic mixtures, oxygen, etc).

 **Danger:** Install the apparatus in a place where it will be protected from blows and from accidental sprays of water or other liquids.

 **Danger:** Do not install the device on or in the vicinity of sources of heat. Install it such a way that there is an adequate circulation of air around it. Leave sufficient free space around it, in particular with reference to the fan on the rear. (Fig.6)

 **Warning:** Do not expose the apparatus to direct sunlight or to sources of UV light.

 **Warning:** The apparatus is transportable, however it must be handled with care when it is moved.

 **Warning:** Before connecting the cord to the device, make sure that the electrical contacts are perfectly dry. If necessary, dry them with the air syringe.

 **Warning:** To avoid risk of electric shock, this equipment must only be

connected to a supply mains with protective earth.

6.2 Initial installation

To ensure perfect operation of the equipment, it is installed by technical personnel authorized by Woodpecker. The equipment will be installed in a suitable and handy place for it to be used.

The technician must:

- 6.2.1 Install the device in a suitable place;
- 6.2.2 Explain the main aspects of correct installation to the user;
- 6.2.3 Fill in the installation form, including the purchaser's data;
- 6.2.4 Send the installation form to Woodpecker to ensure traceability and activation of the warranty.

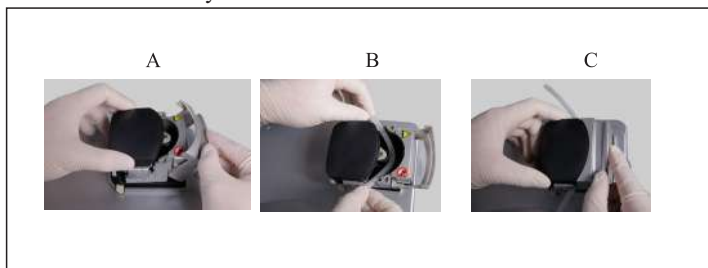

Fig.5

6.3 Connection the accessories

The accessories listed as follow should be connected with the US-II (LED):

- 6.3.1 Insert the silicone tube into the peristaltic pump, proceeding as follows:
 - a) Open the door(Fig.5—Ref.A)as far as it will go.
 - b) Position the tube in the impeller(Fig.5—Ref.B).
 - c) Close the door completely(Fig.5—Ref.C).

⚠ Danger: personnel injury.

The footswitch of the US-II (LED) must not be activated when the door of the peristaltic pump open. (Fig.5—Ref.B).Moving parts could injure the operator.

- 6.3.2 Insert the rod for supporting the bag into the holes provided for it (Fig.6—

Ref.A);

6.3.3 Connect the footswitch to the casting of the device by inserting the plug into the footswitch socket (Fig.6—Ref.D);

6.3.4 Plug the power cable into the connector on the casting of the device (Fig.6—Ref.E) and then into the power outlet;

6.3.5 Insert the handpiece support into the two holes provided for it (Fig.6—Ref. C);

6.3.6 Insert the tube of US-II (LED) cord to the cord connector on the device (Fig.4—Ref.P);

6.3.7 Put the handpiece on the support (Fig.4—Ref.O);

6.3.8 Connect end of the tube of the peristaltic pump;

6.3.9 Connect the flow-control system to the bag containing the appropriate liquid for the treatment;

6.3.10 Use the torque wrench to screw the tip (Fig.8) till the clattering voice;

6.3.11 press the button “on/off” (Fig.6—Ref.B), then can use the device.

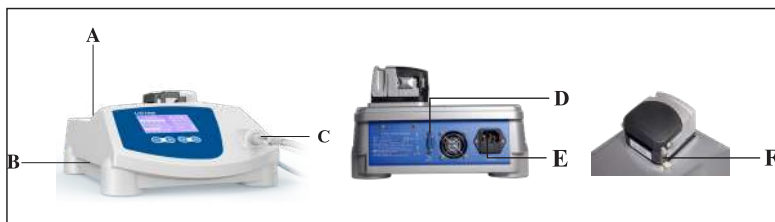

Fig.6



Fig.7

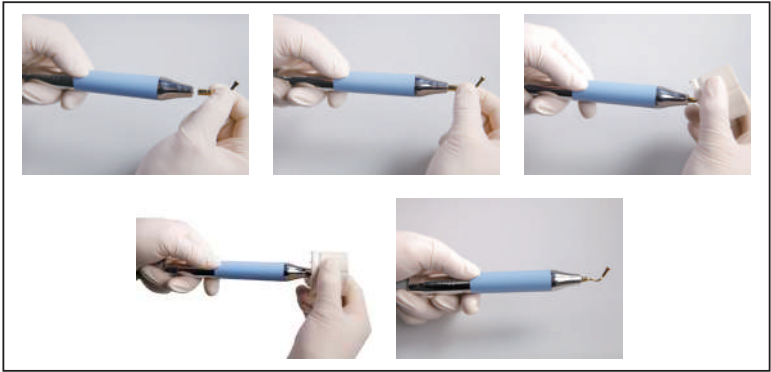

Fig.8

7. Controls

7.1 Description of the controls

This section illustrates the parts of the front panel of the US-II (LED) unit, enabling the controls described in this manual to be located immediately.

7.1.1 Description of bone function:

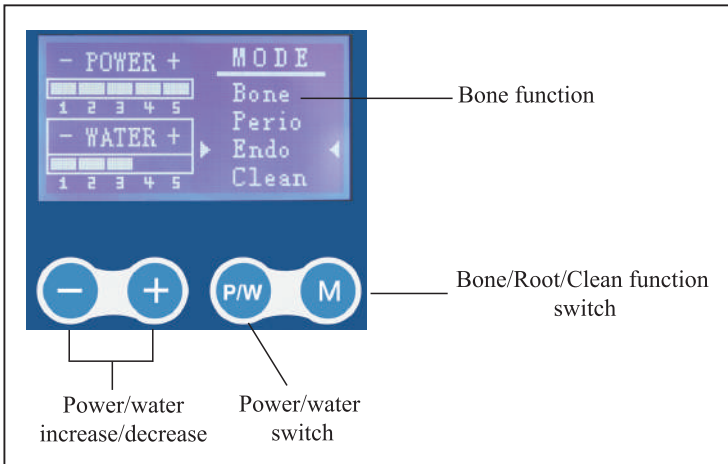

Fig.9

7.1.2 Description of root function:

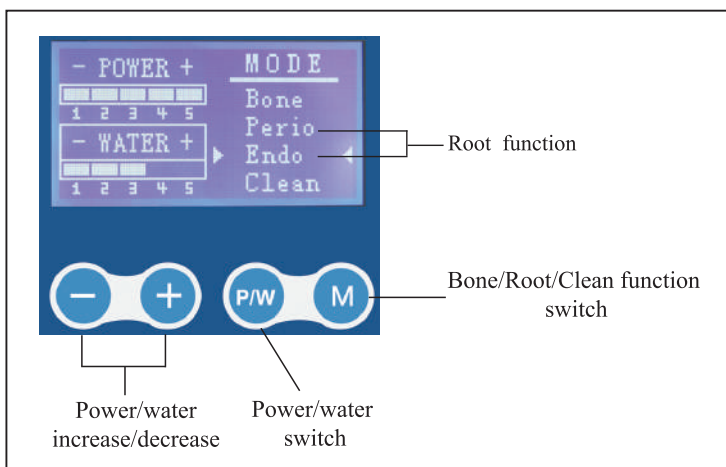

Fig.10

7.1.3 Description of clean function:

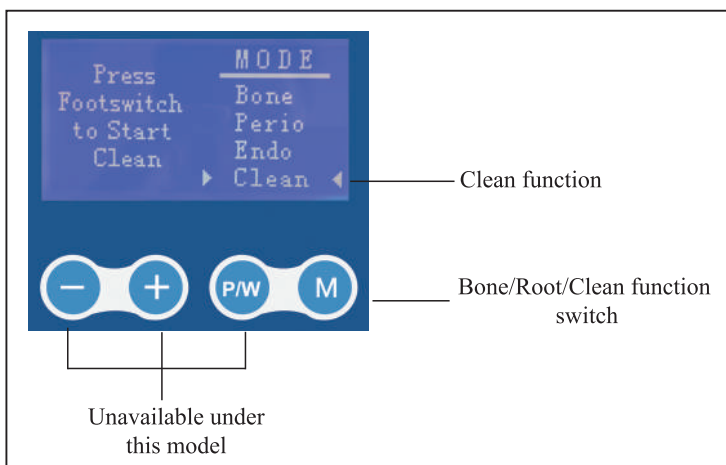

Fig.11

7.2 Description of the display and functions

There are three functions of bone root, clean for this US-II (LED).

7.2.1 BONE function (Fig.9)

In bone function, both the water and power model are available. Five power models as follows:

- a) Power 5: Very high bone density
- b) Power 4: High bone density
- c) Power 3: Middle bone density
- d) Power 2: Low bone density
- e) Power 1: Very low bone density

7.2.2 Root function (Fig.10)

In this function, both the water and power model are available, two models as follow:

- a) Perio.
- b) Endo.

7.2.3 Clean function (Fig.11)

In this function, press the footswitch and hold it on for 3 seconds, the device can clean the tube automatically in 25 seconds.

7.3 Safety requirements during use.



Danger: Contraindications.

Do not use the US-II (LED) on patients with pacemakers or other implantable electronic devices. This requirement also applies to the operator.



Danger: Breakage and wear of the tips.

The high-frequency vibrations and wear may, very occasionally, lead to breakage of the tip. Tips of which the shape has been changed or which are otherwise damaged are liable to break during use. Any such tips should definitely not be used. It is necessary to instruct the patient to breathe through his nose during the treatment in order to avoid ingestion of the broken fragment of the tip.

 **Danger: Control of infections.**

For maximum safety of both the patient and the operator, clean, disinfect and sterilize the piezo electronic handpiece, the tips and the torque wrench after each treatment.

 **Warning: Contraindication.**

Do not carry out this treatment on metal or ceramic prosthetic artifacts. The ultrasonic vibrations could lead to decremending of such artifacts.

 **Warning: Contraindication.**

After autoclave sterilizing of the handpiece, wait for it to cool down completely before using it.

 **Warning: The electrical contacts inside the cord connector must be**

dry.

Before connecting the handpiece to the device, make sure the electrical contacts of the connector are perfectly dry, in particular after the autoclave sterilization cycle. If necessary, dry the contacts by blowing air onto them with the syringe.

 **Warning: To use the device correctly, it is necessary to press the**

footswitch and start it up without letting the tip rest on the part to be treated. This will allow the electronic circuit to detect the point where resonance of the tip is without any interference, thus enabling optimum performance.

If this is not done, contact with the part to be treated or with other surfaces before start-up could cause tripping of the protection systems.



Warning: For spray treatment, use only tips through which liquid is

passed.

7.4 Protection systems and alarms.

The device has a diagnostics circuit that is used to recognize tripping of the protection system and of the alarms. These are shown on the display, as follows:

Warning code	Possible Cause
Warn 01	There is signal transmission problem or handpiece failure.
	Switch the device off and then on again, If the problem persists contact Woodpecker service centre.
Warn 02	Tuning circuit not working properly.
	Handpiece failure.
Warn 03	Fan failure.
Warn 04	Pump failure.
Warn 05	Beyond the electricity.
Warn 06	Tip is not correctly secured to the handpiece or tip is worn or broken or deformed.
	Handpiece failure.
Warn 07	Tuning circuit not working properly.
	Please restart the device, if the problem persists, stop using it and call the Woodpecker service centre immediately.

7.5 Instruction for use

7.5.1 Open the air intake on the drip system;

7.5.2 Screw the chosen tip onto the US-II (LED) handpiece until it is flush against it;

7.5.3 To use the torque wrench correctly (Fig.8) proceed as follow;

a) Hold the body of the handpiece firmly;



Warning: Do not grip the end part of the handpiece or the cord, only

the plastic casting (Fig.8) and do not turn it while fastening the tip in place;

b) Turn the wrench in a clockwise direction until the cultch engages (till making clicking sound);

c) The tip is now properly tightened in place;

7.5.4 Make sure that the US-II (LED) handpiece is correctly connected to the handpiece connector (Fig.6-Ref.C, Fig.7);

7.5.5 Check the display to see the type of power that has been set. If the type of power required different from the type that has been set, use key “M” (see 7.1) to switch;

7.5.6 Check the display to see the power level that has been set, if the type of power required differs from the level that has been set, use the key “+”/“-”(Fig.10) for selecting, depending on the type of function that has been set;

7.5.7 Check the display to see the delivery rate of the peristaltic pump, if the delivery rate required is other than the level that has been set, use the key “+”/“-”(see7.1)to choose,, depending on the type of function that has been set.

7.6 Rules for keeping the device in proper working order

7.6.1 Check the state of wear of the tips periodically and replace any for which a drop in performance is noted;

7.6.2 Do not alter the shape of the tips by bending or filling them;

7.6.3 Replace any tip that has become deformed or damaged by impacts;

7.6.4 Always make sure that any threaded parts and their contact surfaces are perfectly clean;

7.6.5 If an tip becomes too worn, the device will stop working.

7.7 Settings permitted according to insert type

The following table shows the Mode and Power settings permitted for correct use

of the device.

Insert	Mode	Power
US1-US2-US3-US4-US5-US6-US1L-US1R	BONE	Power1-Power5
UL1-UL2-UL3-UL4-UL5	BONE	Power1-Power5
UC1	BONE	Power1-Power5
UI1-UI2-UI7-UI8-UI9	BONE	Power1-Power5
UP1-UP2-UP3-UP4-UP5-UP6-UP7	Perio	Power1-Power5
UE1-UE2-UE3-UE4	Endo	Power1-Power5

8 Cleaning, Disinfection and Sterilization

The cleaning, disinfection and sterilization of handpiece, Torque wrench, Pump tube, Support for the handpiece, Brine bottle connector, Connection for the cord and tube of the peristaltic pump, tips, tip holder, Surgical tray and Silica gel support for the handpiece are as follow. Unless otherwise stated, they will be hereinafter referred to as “products”.

Warning:

The use of strong detergent and disinfectant (alkaline pH > 9 or acid pH < 5) will reduce the life span of products. And in such cases, the manufacturer takes no responsibility.

The products shall not be exposed to high temperature above 138°C.

Processing limit:

The products have been designed for a large number of sterilization cycles. The materials used in manufacture were selected accordingly. However with every renewed preparation for use, thermal and chemical stresses will result in ageing of the products.

The maximum recommended sterilization times for pump tube is 8 times; the maximum allowable sterilization times for handpiece and Silica gel support for the handpiece is 100 times; the maximum allowable sterilization times for tip is 300 times; the maximum allowable sterilization times for connection for the

cord and tube of the peristaltic pump, brine bottle connector, support for the handpiece, torque wrench and surgical tray is 1000 times.

8.1 Initial processing

8.1.1 Processing principles

It is only possible to carry out effective sterilization after the completion of effective cleaning and disinfection. Please ensure that, as part of your responsibility for the sterility of products during use, only sufficiently validated equipment and product-specific procedures are used for cleaning/disinfection and sterilization, and that the validated parameters are adhered to during every cycle. Please also observe the applicable legal requirements in your country as well as the hygiene regulations of the hospital or clinic, especially with regard to the additional requirements for the inactivation of prions.

8.1.2 Post-operative treatment

The post-operative treatment must be carried out immediately, no later than 30 minutes after the completion of the operation. The steps are as follows:

1. Ultrasonic bone surgery is operated in flushing mode for 20-30 seconds to flush the handpiece and tip;
2. Remove the handpiece from the Ultrasonic bone surgery, and rinse away the dirt on the surface of the products with pure water (or distilled water/deionized water);

Note:

- 1) The package used conforms to ISO 11607;
- 2) It can withstand high temperature of 138 °C and has sufficient steam permeability;
- 3) The packaging environment and related tools must be cleaned regularly to ensure cleanliness and prevent the introduction of contaminants;
- 4) Avoid contact with parts of different metals when packaging.

8.2 Preparation before cleaning

Tools: Ultrasonic bone surgery torque wrench, tray, soft brush, clean and dry soft cloth

1. Adjust the machine to the cleaning mode, step on the pedal for 3s to start the cleaning procedure;

Note:

- a) Pure water, distilled water or deionized water should be used at this time.
2. Screw the handpiece interface sealing sleeve of the machine into the interface to ensure that the interface is not eroded by water;
3. Remove the tip from product with Ultrasonic bone surgery torque wrench provided by Guilin Woodpecker Medical Instrument Co., Ltd, and then put the tip and torque wrench into a clean tray.
4. Unscrew the nipple at the front end of the handpiece in a counterclockwise direction, remove the light pipe and LED lamp, and put them into the tray.
5. Use a clean soft brush to carefully brush the front thread, horn, nipple, light pipe and LED lamp until the dirt on surface is not visible. Then use soft cloth to dry the handpiece and accessories and put them into a clean tray. The cleaning agent can be pure water, distilled water or deionized water.

Disassembling steps

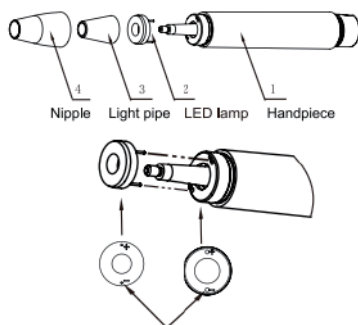

8.3 Cleaning

The cleaning should be performed no later than 24 hours after the operation. The cleaning can be divided into automated cleaning and manual cleaning. Automated cleaning is preferred if conditions permit.

8.3.1 Automated cleaning

- The cleaner is proved to be valid by CE certification in accordance with EN ISO 15883.
- There should be a flushing connector connected to the inner cavity of the product.
- The cleaning procedure is suitable for the products, and the flushing period is sufficient.
- Do not clean the handpiece with ultrasound.

It is recommended to use a washer-disinfector in accordance with EN ISO 15883. For the specific procedure, please refer to the automated disinfection section in the next section «Disinfection».

Note:

- a)The cleaning agent does not have to be pure water. It can be distilled water, deionized water or multi-enzyme. But please ensure that the selected cleaning agent is compatible with the products.
- b)In washing stage, the water temperature should not exceed 45 °C, otherwise the protein will solidify and it would be difficult to remove.
- c)After cleaning, the chemical residue should be less than 10mg / L.

8.4 Disinfection

Disinfection must be performed no later than 2 hours after the cleaning phase. Automated disinfection is preferred if conditions permit.

8.4.1 Automated disinfection-Washer-disinfector

- The washer-disinfector is proved to be valid by CE certification in accordance with EN ISO 15883.
- Use high temperature disinfection function. The temperature does not exceed 134 ° C, and the disinfection under the temperature cannot exceed 20 minutes.
- The disinfection cycle is in accordance with the disinfection cycle in EN ISO 15883.

Cleaning and disinfecting steps by using Washer-disinfector:

- 1.Carefully place the products into the disinfection basket. Fixation of products is needed only when the product is removable in the device. The products are not allowed to contact each other.
- 2.Connect the inner cavity of the product to the flushing connection of the washer-disinfector with a proper cleaning connector.
- 3.Start the program.
- 4.After the program is finished, remove the products from the washer-disinfector, inspect (refer to section «Inspection and Maintenance») and packaging (refer to chapter «Packaging»). Dry the products repeatedly if necessary (refer to section «Drying»).

Note:

- 1)Before use, you must carefully read the operating instructions provided by the equipment manufacturer to familiarize yourself with the disinfection process and precautions.
- 2)With this equipment, cleaning, disinfection and drying will be carried out together.
- 3)Cleaning: (a) The cleaning procedure should be suitable for the products to be treated. The flushing period should be sufficient (5-10 minutes). Pre-wash for 3 minutes, wash for another 5 minutes, and rinse it for twice with each rinse lasting for 1 minute. (b) In the washing stage, the water temperature should not exceed 45 °C, otherwise the protein will solidify and it is difficult to remove. (c) The

solution used can be pure water, distilled water, deionized water or multi-enzyme solution, etc., and only freshly prepared solutions can be used. (d) During the use of cleaner, the concentration and time provided by manufacturer shall be obeyed. The used cleaner is neodisher MediZym (Dr. Weigert).

4) Disinfection: (a) Direct use after disinfection: temperature $\geq 90^{\circ}\text{C}$, time ≥ 5 min or $A_0 \geq 3000$;

Sterilize it after disinfection and use: temperature $\geq 90^{\circ}\text{C}$, time ≥ 1 min or $A_0 \geq 600$

(b) The disinfection temperature used here is 93°C , the time is 2.5 min, and $A_0 > 3000$

5) Only distilled or deionized water with a small amount of microorganisms (< 10 cfu/ml) can be used for all rinsing steps. (For example, pure water that is in accordance with the European Pharmacopoeia or the United States Pharmacopoeia).

6) After cleaning, the chemical residue should be less than $10\text{mg} / \text{L}$.

7) The air used for drying must be filtered by HEPA.

8) Regularly repair and inspect the disinfectant.

8.5 Drying

If your cleaning and disinfection process does not have an automatic drying function, dry it after cleaning and disinfection.

Methods:

1. Spread a clean white paper (white cloth) on the flat table, point the products against the white paper (white cloth), and then dry the products with filtered dry compressed air (maximum pressure 3 bar). Until no liquid is sprayed onto the white paper (white cloth), the products drying is completed.

2. It can also be dried directly in a medical drying cabinet (or oven). The recommended drying temperature is $80^{\circ}\text{C} \sim 120^{\circ}\text{C}$ and the time should be 15~40 minutes.

Note:

1) The drying of product must be performed in a clean place.

2) The drying temperature should not exceed 138°C ;

3) The equipment used should be inspected and maintained regularly.

8.6 Inspection and maintenance

In this chapter, we only check the appearance of the products. After inspection, if there is no problem, the handpiece should be immediately reassembled, installing the LED, light guide, and cone head in sequence to the handpiece, and then tighten the cone head clockwise.

1. Check the products. If there is still visible stain on the products after cleaning/disinfection, the entire cleaning/disinfection process must be repeated.

2. Check the products. If it is obviously damaged, smashed, detached, corroded or bent, it must be scrapped and not allowed to continue to be used.

3. Check the products. If the accessories are found to be damaged, please replace it before use. And the new accessories for replacement must be cleaned, disinfected and dried.

4. If the service time (number of times) of the products reaches the specified service life (number of times), please replace it in time.

8.7 Packaging

Install the disinfected and dried products and quickly package it in a medical sterilization bag (or special holder, sterile box).

Note:

- 1) The package used conforms to ISO 11607;
- 2) It can withstand high temperature of 138 °C and has sufficient steam permeability;
- 3) The packaging environment and related tools must be cleaned regularly to ensure cleanliness and prevent the introduction of contaminants;
- 4) Avoid contact with parts of different metals when packaging.

8.8 Sterilization

Use only the following steam sterilization procedures (fractional pre-vacuum procedure*) for sterilization, and other sterilization procedures are prohibited:

1. The steam sterilizer complies with EN13060 or is certified according to EN 285 to comply with EN ISO 17665;
2. The highest sterilization temperature is 138 °C;
3. The sterilization time is at least 4 minutes at a temperature of 132 °C / 134 °C and a pressure of 2.0 bar ~ 2.3 bars.
4. Allow a maximum sterilization time of 20 minutes at 134 °C.

Verification of the fundamental suitability of the products for effective steam sterilization was provided by a verified testing laboratory.

Note:

- 1) Only products that have been effectively cleaned and disinfected are allowed to be sterilized;
- 2) Before using the sterilizer for sterilization, read the Instruction Manual provided by the equipment manufacturer and follow the instructions.
- 3) Do not use hot air sterilization and radiation sterilization as this may result in damage to the product;
- 4) Please use the recommended sterilization procedures for sterilization. It is not recommended to sterilize with other sterilization procedures such as ethylene oxide, formaldehyde and low temperature plasma sterilization. The manufacturer assumes no responsibility for the procedures that have not been recommended. If you use the sterilization procedures that have not been recommended, please adhere to related effective standards and verify the suitability and effectiveness. Fractional pre-vacuum procedure = steam sterilization with repetitive pre-vacuum. The procedure used here is to perform steam sterilization through three

pre-vacuums.

8.9 Storage

1.Store in a clean, dry, ventilated, non-corrosive atmosphere with a relative humidity of 10% to 93%, an atmospheric pressure of 70KPa to 106KPa, and a temperature of -20 °C to +55 °C;

2.After sterilization,the product should be packaged in a medical sterilization bag or a clean sealing container, and stored in a special storage cabinet. The storage time should not exceed 7 days. If it is exceeded, it should be reprocessed before use.

Note:

1)The storage environment should be clean and must be disinfected regularly;

2)Product storage must be batched and marked and recorded.

8.10Transportation

1.Prevent excessive shock and vibration during transportation, and handle with care;

2.It should not be mixed with dangerous goods during transportation.

3.Avoid exposure to sun or rain or snow during transportation.

The cleaning and disinfection of main unit are as follows:

- Before each use, wipe the surface of the machine and the tail cord of the handpiece with a soft cloth or paper towel soaked in 75% medical alcohol. Repeat the wiping for at least 3 times.

- Before each use, please let the Ultrasonic Periodontal Treatment Device work under irrigation mode for 20-30s, and then install the handpiece.

- After each use, please let the Ultrasonic Periodontal Treatment Device work under irrigation mode for 20-30s, and then remove the handpiece.

- After each use, wipe the surface of the device and the tail cord of the handpiece with a soft cloth soaked in clean water (distilled or deionized water) or a clean disposable wipe. Repeat the wiping for at least 3 times.

9. Regular maintenance

9.1 handle this device gently, keep away from the shake source, and should install and store in shade.

9.2 Do not mix with poison, causticity, explosive and combustibile things together.

9.3 This equipment should be stored in a room where the relative humidity is 10% ~ 93%, atmospheric pressure is 70kPa to106kPa, and the temperature is

-20°C ~ +55°C.

9.4 If the device is not used for a long time running, it is better to connect the electricity and water one time per month, 5 minutes per time.

9.5 disconnect the device from the power mains.



Danger: Check regularly that the power cable is intact, if it is

damaged, replace it with an Woodpecker spare.

10. Replacement of the fuses



Danger: Switch off the apparatus.

Always turn off the apparatus by means of the switch (Fig.5-Ref.B) and disconnect it from the power outlet before carrying out the following maintenance activities.

10.1 Insert the flat tip of a screwdriver into the recess in the fuse compartment below the power socket and use it as a lever (Fig.12-Ref.A);

10.2 Pull out the fuse compartment(Fig.12-Ref.B);

10.3 Danger: Replace the fuses, using fuses of the type indicated on the identification label on the bottom of the apparatus;

10.4 Put the compartment back into place (Fig.12-Ref.B).

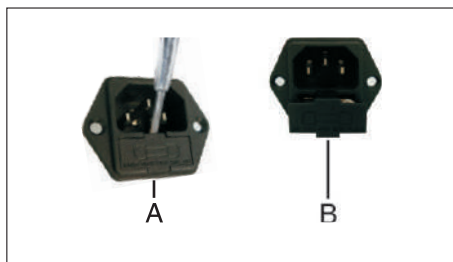

Fig.12

11. Disposal procedures and precautions

Danger: Hospital waste

Treat the following items as hospital waste

- Tips, when worn or broken.
- Irrigator, after each treatment.
- Tube of the peristaltic pump, after 8 sterilizing cycles.
- Torque wrench for tightening tips, when worn or broken.

12. Tips

12.1 Sharp tips

The sharp edges of these tips can be used to treat bone structures efficiently and effectively. Sharp tips are used in osteotomy and osteoplasty when a fine and well-defined cut in the bone structure concerned is required, there are also tips with sharp edges for osteoplasty techniques and for removing bone fragments.

12.2 Smoothing tips

















The smoothing tips have surfaces shaped in such a way that they can be used to work the bone structures with precision and in a controlled manner. Smoothing tips are used in osteotomy when it is necessary to prepare difficult and delicate structures such as those for preparing a maxillary sinus window or to complete

preparation of the site of an implant.

12.3 Blunt tips

Blunt tips are used for separating the soft tissues, for example for detaching schneider's membrane or for lateralizing nerves. In periodontology, these tips are used to smooth the root surfaces.

13. Symbols

	Follow instructions for use		Use indoor only
	Alternating current		Socket for the foot switch
	Manufacturer		Date of manufacture
IPX1	Drip-proof		Caution mechanical injury
	Can be autoclaved		Type B applied part
	Protective earthing		CE marked product
	Atmospheric pressure for storage		Serial number
	Humidity limitation for storage		Temperature limitation for storage
	Appliance compliance WEEE directive		
IPX8	Degree of protection against the impact of continuous diving		
	Authorised Representative in the EUROPEAN COMMUNITY		

14. Troubleshooting

If the device does not seem to be working properly, read the instruction again and then check the following table:

Problem	Possible cause	solution
The device does not turn on when the switch it positioned on ON.	The connector on the end of the power cable is plugged into the socket on the rear of the device properly.	Check that the power cable is firmly connected.
	The power cable is faulty.	Check that the power outlet is working properly. Replace the power cable.
	The fuses blew out.	Replace the fuses.
The connector on the end of the power cable is plugged into the socket on the rear of the device properly.	The connector of the footswitch is not properly plugged into the socket.	Insert the footswitch connector properly.
	The footswitch will not work.	Contact the nearest dealer or authorized Woodpecker service centre.
A faint whistle can be heard coming from the US-II (LED) handpiece during operation.	The tip is not correctly tightened onto the handpiece.	Unscrew the tip and screw it back into place correctly.
The device is switched on but does not work, the message WARN appears on the display.	The tip is not fitted correctly into the handpiece.	Unscrew the tip and screw it back into place correctly.
	The tip is worn, broken or deformed.	Replace the tip.
	The connector of the cord is wet.	Dry the connectors.

Problem	Possible cause	solution
The device is switched on but will not work, the message WARN appears on the display.	Cord not connected to the device.	Connect the cord to the device.
	Lack of continuity of a lead in the cord.	Contact the nearest dealer or authorized Woodpecker service centre.
	Handpiece failure.	Contact the nearest dealer or authorized Woodpecker service centre.
	Malfunctioning of the tuning circuit.	Contact the nearest dealer or authorized Woodpecker service centre.
No liquid comes out of the tip during operation.	The tip is of the type with no through-flow of liquid.	Use an tip of the type with through-flow of liquid.
	The bag of liquid is empty.	Replace the bag with a full one.
	The cover of pump that connected with the water tube is open.	Close the cover.
	The tubes of the drip system and of the pump have not been correctly installed.	Check the connections of the tubes.
	The tip is clogged.	Free the passage in the tip through which the water passes.

Problem	Possible cause	solution
No liquid comes out of the tip during operation.	The handpiece is clogged.	Contact the nearest dealer or authorized Woodpecker service centre.
The device is working properly, but the pump is being forced.	Too much pressure by the impeller on the tube in the peristaltic pump.	Check that the tube in the peristaltic pump has been correctly inserted.
The pump is running correctly but when it stops liquid comes out of the handpiece.	The door of the peristaltic pump is not closed properly.	Make sure that the door of the peristaltic pump is properly closed.
Insufficient power.	The tip is not correctly fitted to the handpiece (the message WARN appears on the display).	Unscrew the tip and screw it back into place correctly.
	The tip is worn, broken or deformed (the message WARN appears on the display).	Replace the tip.
LCD screen mess or incomplete display.	Voltage interference.	Stop any operation, change the model then return to the original model or restart the machine.

15. Technical data

15.1 Device in accordance with Directive 93/42EEC.

15.2 According to EN60529: IPX1 (device)

IPX8 (footswitch)

15.3 Device for intermittent operation: 60s ON, 10s OFF

15.4 Power-supply voltage: $\sim 100\text{V}-240\text{V}$ 50Hz/60Hz 120VA

15.5 Fuses: $2 \times 1.6\text{AT}$ 250V

15.6 Working frequency: $24\text{kHz} \sim 36\text{kHz}$

15.7 Flow: $25 \sim 110\text{ml/m}$

15.8 Protection systems and tripping time of the APC:

No handpiece connected: 10ms

Cord interrupted: 10ms

Tips broken or not correctly tightened: $< 500\text{ms}$

Protection by discharge to earth: 10ms

15.9 Alarm: Front display show the e (see point 7.3 and 14)

15.10 Operation environment:

a) Environment temperatuer: $+5^{\circ}\text{C} \sim +40^{\circ}\text{C}$

b) Relative humidity: $30\% \sim 75\%$

c) Atmosphere pressure: $70\text{kPa} \sim 106\text{kPa}$

d) Temperature in the water inlet of water-cooling equipment is not higher than 25°C

15.11 Delivery and store environment: This equipment should be stored in a room where the relative humidity is $10\% \sim 93\%$, atmospheric pressure is 70kPa to 106kPa , and the temperature is $-20^{\circ}\text{C} \sim +55^{\circ}\text{C}$.

15.12 Pump tube: less than 8 sterilization cycles is highly recommended

15.13 Size of main unit: $330\text{ mm} \times 254\text{ mm} \times 167\text{mm}$

15.14 Weight of main unit: 3.1kg

15.15 Type of protection against electric shock: Class I equipment

15.16 Degree of protection against electric shock: Type B applied part

16. After service

We offer two year, free repair to the equipment according to the warranty card. The repair of the equipment should be carried out by our professional technician. We are not responsible for any irretrievable damage caused by the non-professional person.

17. Environmental protection

Please dispose according to the local laws.

18. Manufacturer's right

We reserve the right to change the design of the equipment, the technique, fittings, the instruction manual and the content of the original packing list at any time without notice. If there are some differences between blueprint and real equipment, take the real equipment as the norm.

19. European authorized representative

EC REP MedNet EC-Rep GmbH
Borkstrasse 10 · 48163 Muenster · Germany

20. Declaration of conformity- EMC

Guidance and manufacturer's declaration - electromagnetic emissions		
The models US-II LED, US-II are intended for use in the electromagnetic environment specified below. The customer or the user of the models US-II LED, US-II should assure that it is used in such an environment.		
Emissions test C	ompliance	Electromagnetic environment - guidance
RF emissions CISPR 11	Group 1	The models US-II LED, US-II use RF energy only for its internal function. Therefore, its RF emissions are very low and are not likely to cause any interference in nearby electronic equipment.
RF emissions CISPR 11	Class B	The models US-II LED, US-II are suitable for used in domestic establishment and in establishment directly connected to a low voltage power supply network which supplies buildings used for domestic purposes.
Harmonic emissions IEC 61000-3-2	Class A	
Voltage fluctuations / flicker emissions IEC 61000-3-3	Complies	

Guidance & Declaration — electromagnetic immunity			
The models US-II LED, US-II are intended for use in the electromagnetic environment specified below. The customer or the user of the models US-II LED, US-II should assure that It is used in such an environment.			
Immunity test	IEC 60601 test level	Compliance level	Electromagnetic environment - guidance
Electrostatic discharge (ESD) IEC 61000-4-2	±8 kV contact ±2 kV, ±4 kV, ±8 kV, ±15 kV air	±8 kV contact ±2 kV, ±4 kV, ±8 kV, ±15 kV air	Floors should be wood, concrete or ceramic tile. If floors are covered with synthetic material, the relative humidity should be at least 30 %.
Electrical fast transient/burst IEC 61000-4-4	±2kV for power supply lines ±1 kV for Input/output lines	±2kV for power supply lines ±1kV for interconnecting cable	Mains power quality should be that of a typical commercial or hospital environment.
Surge IEC 61000-4-5	±1 kV line to line ±2 kV line to earth	±1 kV line to line	Mains power quality should be that of a typical commercial or hospital environment.
Voltage dips, short interruptions and voltage variations on power supply input lines IEC 61000-4-11.	<5 % U_T (>95% dip in U_T) for 0.5 cycle 40 % U_T (60% dip in U_T) for 5 cycles 70% U_T (30% dip in U_T) for 25 cycles <5% U_T (>95 % dip in U_T) for 5 sec	<5 % U_T (>95% dip in U_T) for 0.5 cycle 40 % U_T (60% dip in U_T) for 5 cycles 70% U_T (30% dip in U_T) for 25 cycles <5% U_T (>95 % dip in U_T) for 5 sec	Mains power quality should be that of a typical commercial or hospital environment. If the user of the models US-II LED, US-II require continued operation during power mains interruptions, it is recommended that the models US-II LED, US-II be powered from an uninterruptible power supply or a battery.
Power frequency (50/60 Hz) magnetic field IEC 61000-4-8	3 A/m	3 A/m	Power frequency magnetic fields should be at levels characteristic of a typical location in a typical commercial or hospital environment.
NOTE U_T is the a.c. mains voltage prior to application of the test level.			

Guidance & Declaration - Electromagnetic immunity

The models US-II LED, US-II are intended for use in the electromagnetic environment specified below. The customer or the user of the models US-II LED, US-II should assure that it is used in such an environment.

Immunity test	IEC 60601 test level	Compliance level	Electromagnetic environment - guidance
Conducted RF IEC 61000-4-6 Radiated RF IEC 61000-4-3	3 Vrms 150 kHz to 80 MHz 3 V/m 80 MHz to 2.5 GHz	3V d 3 V/m	Portable and mobile RF communications equipment should be used no closer to any part of the models US-II LED, US-II, including cables, than the recommended separation distance calculated from the equation applicable to the frequency of the transmitter. Recommended separation distance $= [3.5 \sqrt{V_i}] \times P^{1/2}$ $d = 1.2 \times P^{1/2}$ 80 MHz to 800 MHz $d = 2.3 \times P^{1/2}$ 800 MHz to 2.5 GHz where P is the maximum output power rating of the transmitter in watts (W) according to the transmitter manufacturer and d is the recommended separation distance in meters (m). Field strengths from fixed RF transmitters, as determined by an electromagnetic site survey, ^a should be less than the compliance level in each frequency range. ^b Interference may occur in the vicinity of equipment marked with the following symbol: 

NOTE 1 At 80 MHz end 800 MHz. the higher frequency range applies.

NOTE 2 These guidelines may not apply in all situations. Electromagnetic propagation is affected by absorption and reflection from structures, objects and people.

- ^a Field strengths from fixed transmitters, such as base stations for radio (cellular/cordless) telephones and land mobile radios, amateur radio, AM and FM radio broadcast and TV broadcast cannot be predicted theoretically with accuracy. To assess the electromagnetic environment due to fixed RF transmitters, an electromagnetic site survey should be considered. If the measured field strength in the location in which the models US-II LED, US-II are used exceeds the applicable RF compliance level above, the model US-II LED, US-II should be observed to verify normal operation. If abnormal performance is observed, additional measures may be necessary, such as reorienting or relocating the models US-II LED, US-II.
- ^b Over the frequency range 150 kHz to 80 MHz, field strengths should be less than 3V/m.

Recommended separation distances between portable and mobile RF communications equipment and the models US-II LED, US-II

The models US-II LED, US-II are intended for use in electromagnetic environment in which radiated RF disturbances is controlled. The customer or the user of the models US-II LED, US-II can help prevent electromagnetic interference by maintaining a minimum distance between portable and mobile RF communications equipment (transmitters) and the models US-II LED, US-II are recommended below, according to the maximum output power of the communications equipment.

Rated maximum output power of transmitter W	Separation distance according to frequency of transmitter m		
	150kHz to 80MHz $d=1.2 \times P^{1/2}$	80MHz to 800MHz $d=1.2 \times P^{1/2}$	800MHz to 2,5GHz $d=2.3 \times P^{1/2}$
0,01	0.12	0.12	0.23
0,1	0.38	0.38	0.73
1	1.2	1.2	2.3
10	3.8	3.8	7.3
100	12	12	23

For transmitters rated at a maximum output power not listed above, the recommended separation distance d in meters (m) can be estimated using the equation applicable to the frequency of the transmitter, where P is the maximum output power rating of the transmitter in watts (W) according to the transmitter manufacturer.

NOTE 1 At 80 MHz and 800 MHz, the separation distance for the higher frequency range applies.

NOTE 2 These guidelines may not apply in all situations. Electromagnetic propagation is affected by absorption and reflection from structures, objects and people.

The device has been tested and homologated in accordance with EN 60601-1-2 EMC. This does not guarantee in any way that this device will not be affected by electromagnetic interference. Avoid using the device in high electromagnetic environment.

21. Guarantee

21.1 Before being placed on the market, all WOODPECKER equipment undergoes a thorough final check to ensure that it is in proper working order.

21.2 WOODPECKER guarantees its products, purchased new from a WOODPECKER dealer or importer, to be free from manufacturing or material defects for:

- TWO YEAR from the date of purchase for the device;

- ONE YEAR from the date of purchase for the handpiece with its cord.

21.3 Throughout the warranty period, WOODPECKER undertakes to repair (or, at their sole discretion, to replace) free of charge any parts that, in their opinion,

are faulty.

Complete replacement of WOODPECKER products is excluded

21.4 Woodpecker cannot accept any liability for direct or incidental damage or personal injury in the following cases:

21.4.1 If the equipment is used for purposes other than that for which it is intended;

21.4.2 If the equipment is not used in accordance with all the instruction and requirement described in this manual;

21.4.3 If the wiring system in the room where the equipment is used does not comply with the applicable standards and appropriate requirements;

21.4.4 If any assemble operations, extensions, settings, alterations or repairs have been carried out by personnel not authorized by Woodpecker;

21.4.5 If the environmental conditions in which the device is kept and stored do not comply with the requirements indicated in the chapter on technical specifications.

21.5 Accidental damages due to transport, incorrect use or carelessness or to connection to power supplies other than as envisaged and damage to the signaling lamps handpiece and all accessories are excluded from the warranty.

The warranty will no longer apply if the apparatus has been tampered with or repaired by unauthorized personnel.

21.6 Warning:

The warranty is valid only if the warranty slip enclosed with the product has been completed in full and returned to us or, if appropriate, to your WOODPECKER dealer or importer within 20 days from the date of purchase, as proven by the consignment note/invoice issued by the dealer/importer.

In order to benefit from the warranty service, the customer must return the apparatus to be repaired to the WOODPECKER dealer/importer from which it was purchased, at his own expense.

21.7 The apparatus should be returned suitable packed (possibly in its original

packing material).

21.8 Accompanied by all the accessories and by the following information:

21.8.1 Owner's details, including his telephone number;

21.8.2 Details of the dealer/importer;

21.8.3 Photocopy of the consignment note/purchase invoice of the apparatus issued to the owner and indicating, in addition to the date, also the name of the apparatus and its serial number;

21.8.4 A description of the problem.

21.9 Transport and any damages caused during transport are not covered by the warranty

In the event of failure due to accidents or improper use, or if the warranty has lapsed, repairs to WOODPECKER produces will be charged on the basis of the actual cost of the materials and labour required for such repairs.

22. Statement

This is to certify that all the functions of the equipment have been tested rigidly. All the functions run normally. In special condition, abnormal phenomenon may happen due to the unavoidable interference.

In the equipment, power network or static interference may make the display screen display white flake. This phenomenon does not influence the operation of normal functions. Solvents: Stop the equipment, press the top-right key-press on the display panel to change the display of screen, then return. Thus the equipment can display normally. Or turn off the power supply, restart the equipment.

All rights of modifying the product are reserved to the manufacturer without further notice. The pictures are only for reference. The final interpretation rights belong to GUILIN WOODPECKER MEDICAL INSTRUMENT CO., LTD. The industrial design, inner structure, etc, have claimed for several patents by WOODPECKER, any copy or fake product must take legal responsibilities.

Scan and Login website
for more information



Guilin Woodpecker Medical Instrument Co., Ltd.
Information Industrial Park, Guilin National High-Tech
Zone, Guilin, Guangxi, 541004 P. R. China

Tel:

Europe Sales Dept.: +86-773-5873196

North/South America & Oceania Sales Dep.: +86-773-5873198

Asia & Africa Sales Dep.: +86-773-5855350 Fax: +86-773-5822450

E-mail: woodpecker@glwoodpecker.com, sales@glwoodpecker.com

Website: <http://www.glwoodpecker.com>



MedNet EC-Rep GmbH
Borkstrasse 10 · 48163 Muenster · Germany