



OWANDY-RX

PRECISION AND SIMPLICITY

AC/DC INTRAORAL RADIOLOGY SYSTEM

Owandy-RX

HIGH FREQUENCY TECHNOLOGY

2 versions available:
High frequency (DC)
Standard (AC)

INTUITIVE

Clearly labelled,
with simple,
user-friendly
configuration

DESIGN

Subtle, compact
design that can
adapt to all
situations

ERGONOMICS & ACCURACY

Flexible and adjustable
arms to obtain exactly
the right position.
3 arm lengths
available

1 TIMER / 2 GENERATORS

Includes a digital
timer for controlling
two different
generators

MOBILE VERSION

A mobile version of the
Owandy-RX is also
available





Accuracy & reliability

The new Owandy-RX intraoral radiology system is known for its accuracy and reliability.

Enjoy consistent exposure settings as well as high quality radiation!



Ergonomic design, flexible arm

Designed to withstand the stresses of daily use. The arm is easy to adjust, flexible and robust.

Its 3 arm lengths are designed to adapt to the layout of your surgery, tailoring the unit to your workstation as effectively as possible.

Contemporary, subtle and compact, this unit blends seamlessly into your surgery's environment.



User friendly

The Owandy-RX is very intuitive to use and requires no special staff training.

All settings are easy to configure (exposure time, patient typology, kV, mA, etc.)

The Owandy-RX works with all receiver terminals: digital sensors, imaging plates, films, etc.



Minimal dose **affording maximum protection**

The safety of your patients is one of our key priorities!

Its High Frequency technology reduces x-rays considerably, eliminating harmful soft rays.

The Owandy-RX is fitted with a remote manual release button for conducting examinations in complete safety

Clinical cases with phosphor imaging plates

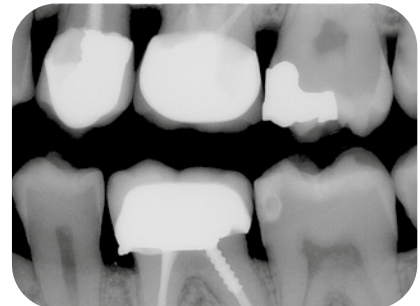
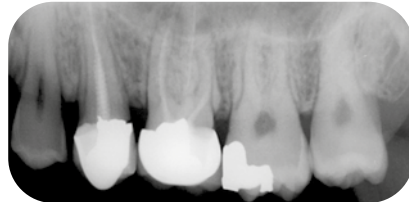
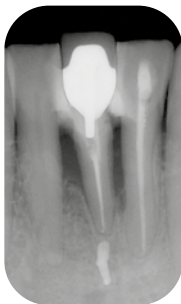

Clinical cases with digital sensors

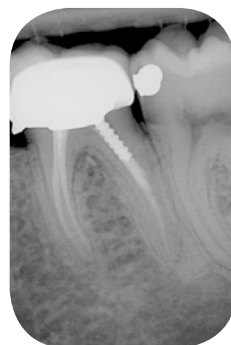
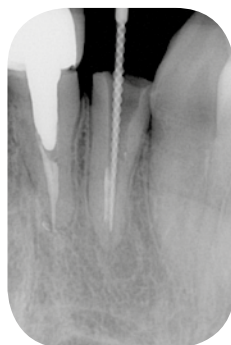



Technical features

	OWANDY-RX AC	OWANDY-RX DC
Category	Class I, type B (CEI EN60601-1:2007)	
Supply voltage	115/220/230 V - single phase 50/60 Hz	115/230 V - single phase 50/60 Hz
Power input	0,8 kVA	1,4 kVA
High voltage	70 kV	60 à 70 kV
Anode current	8 mA	4 à 8 mA
Focus	0,7 mm	
Total filtration	Equivalent to 2 mm Al. à 70 kV	
Leakage radiation	< 0,25 mGy/h	
Technology	Alternating current	Direct current
Timer	from 0.08 to 3.2 secs	from 0.02 to 3.2 secs
Head weight	9 kg	5,5 kg
Total weight	23 kg	19,5 kg
Arm extensions	41 cm / 82,5 cm / 110 cm	
Options	Mobile version	
Accessories	Long cone (31cm) / Short cone (20cm) / Long rectangular cone (31cm)	

Technical diagrams

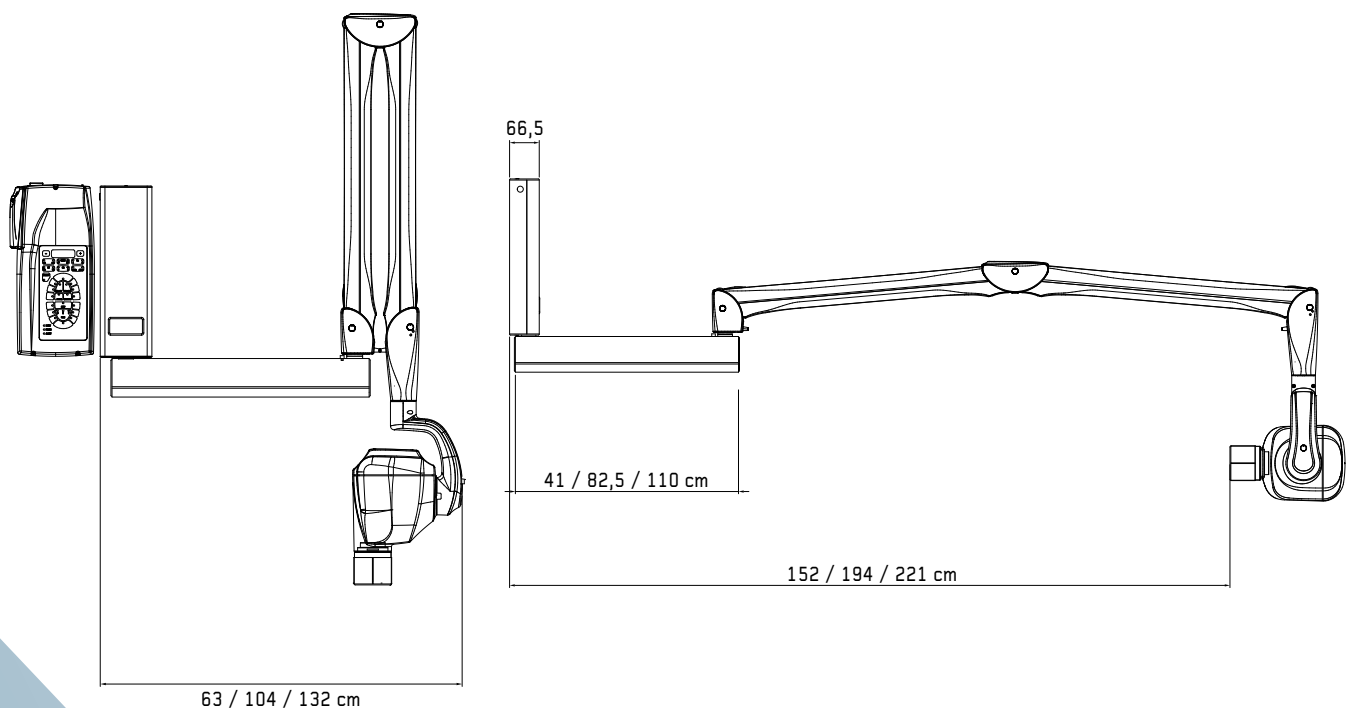

DIGITAL WORKFLOW OWANDY RADIOLOGY

A COMPREHENSIVE RANGE TO MEET ALL YOUR REQUIREMENTS

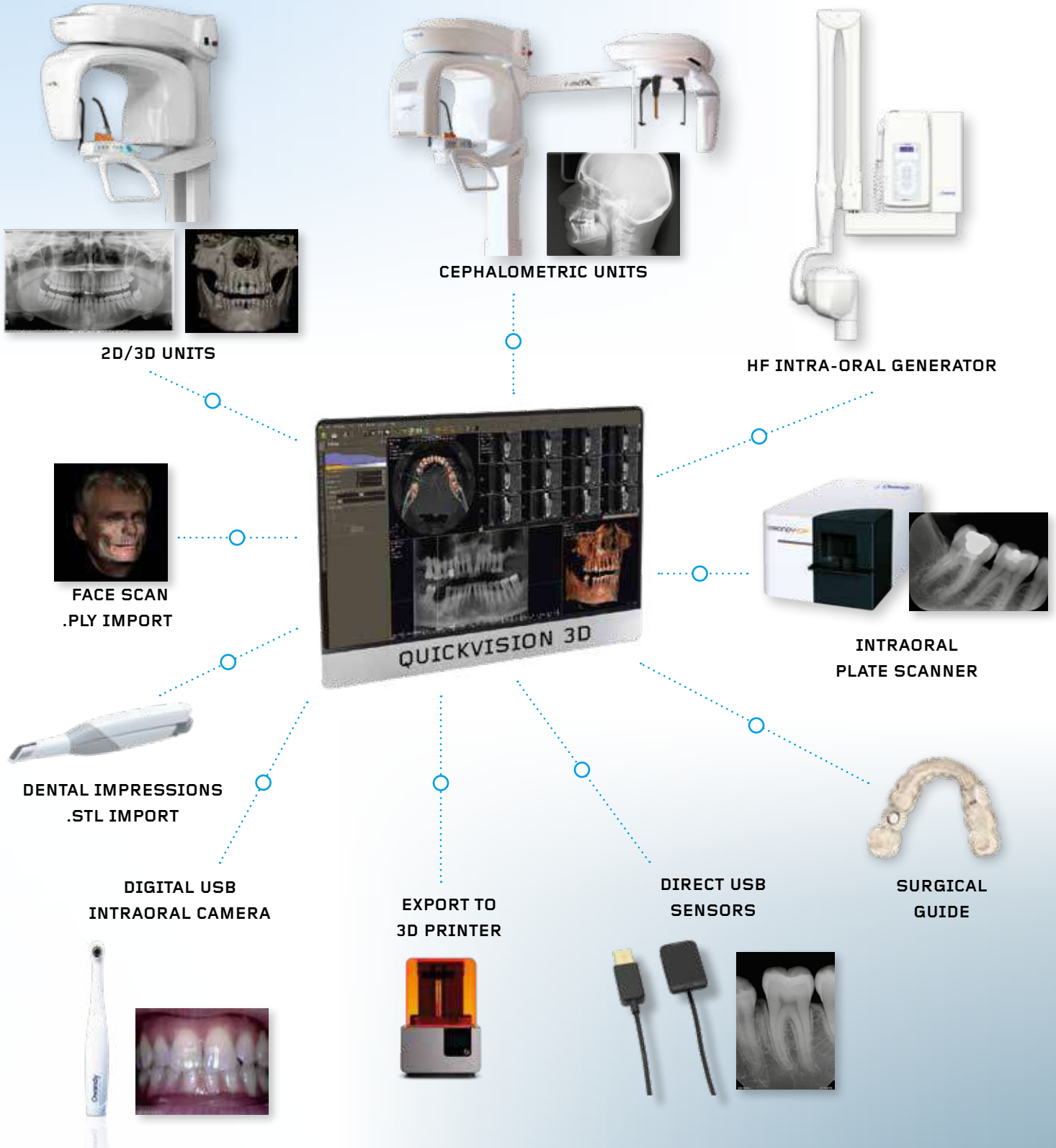

BR_OWANDYRX-ACDC_EN_REV00

