

I AM SAFER



X MIND
unity

Reliable X-ray
technology
that reduces
radiation exposure



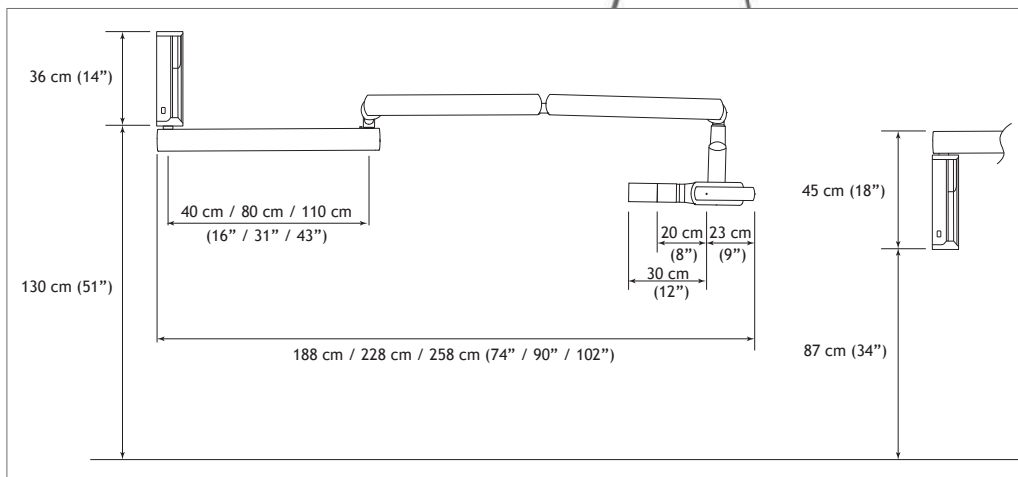
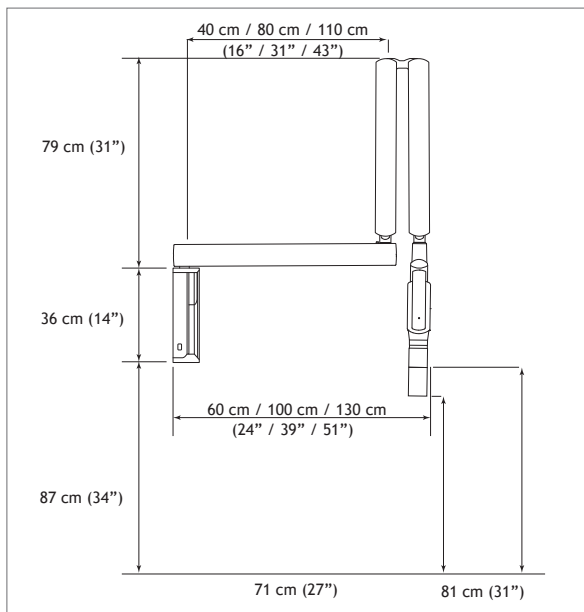
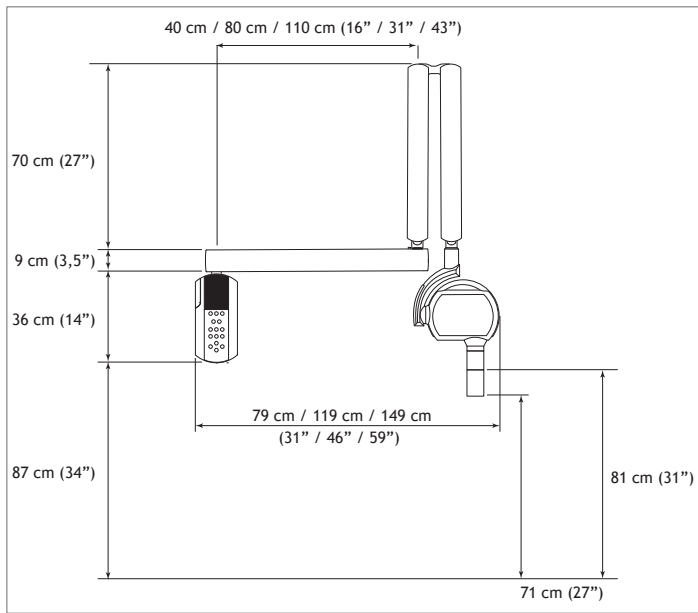

The medical devices for dental care SOPIX Series are of class IIa and manufactured by SOPRO, notified body LNE/GMED, X-Mind unity is of class IIb and manufactured by DE GOTZEN, notified body DNV GL NEMKO PRESAFE - CE 2460. These medical devices are not refunded by health insurance organizations. Read carefully the instructions on the labelling before use. Manufactured in compliance with currently applicable regulations and standards (EC Directive 93/42/EEC and sub-segment amendment). IEC 60601-2-65 imposes for each X-ray generator furnished with a digital sensor to use a square cone.

SOPIX®, and SOPRO® are registered trademarks of SOPRO. X-Mind® is registered trademarks of DE GÖTZEN.
 "All other trademarks cited herein are the property of their respective owners"



MORE INVENTIVE

Combined with the X-Mind® unity intraoral X-ray generator, SOPIX® inside with ACE technology **limits the emission of X-rays** during the acquisition to the necessary amount for the patient's morphology. It uses the **minimum dose** required to provide a high-quality image.

LESS INVASIVE

Using X-Mind® unity intraoral X-ray generator with SOPIX® inside, the patients **receive the minimum dose required for their dental morphology**. Patients and staff are protected from unnecessary radiation.

Chris SALIERNO
DDS
*United States
of America*

▼
▼
▼

It's frustrating when a portable sensor goes missing or gets damaged. Having the sensor integrated with the tube head makes a lot of sense. My team can use the X-Mind® unity without delay; saving time means saving money.

A UNIQUE COMBINATION FOR EFFECTIVE PROTECTION

LOW DOSE

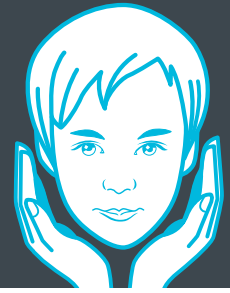

X MIND
unity



Ace
technology

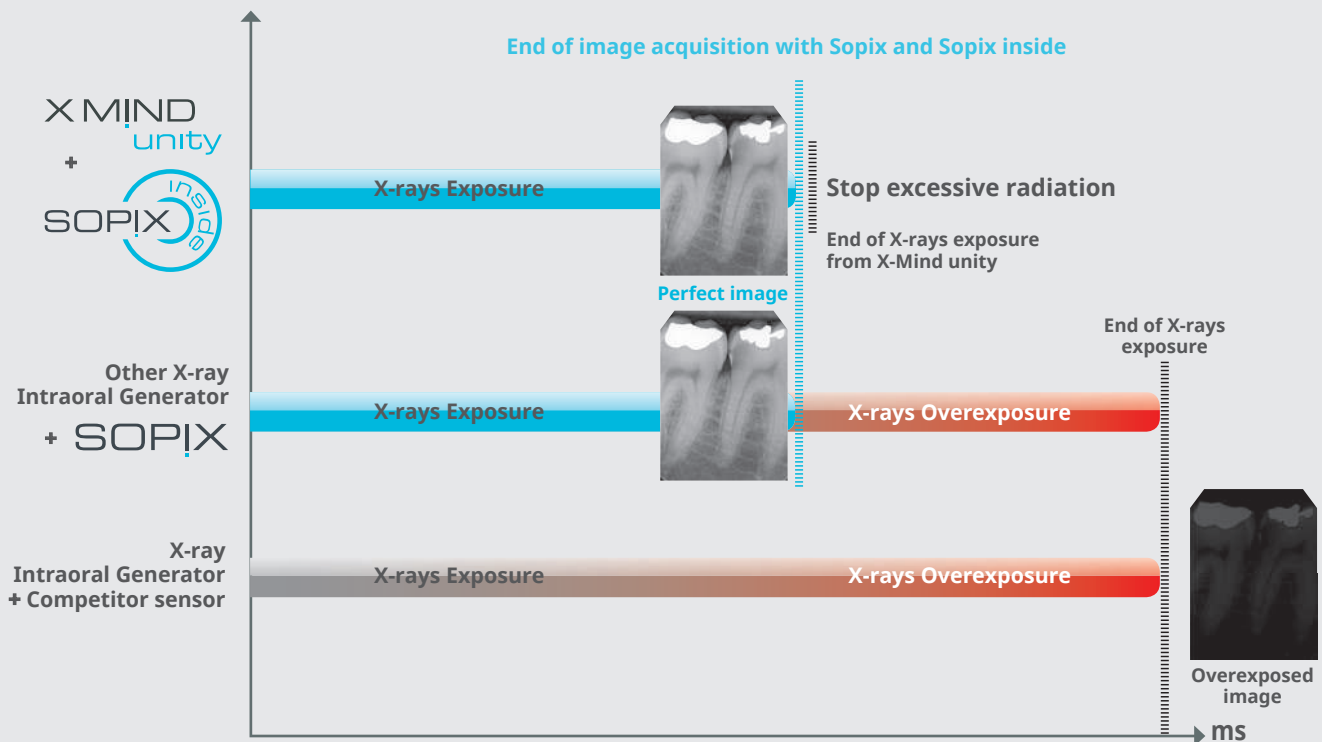

A SHARP AND CONTRASTED IMAGE

CLINICAL CASES USING SOPIX² INSIDE AND X-MIND UNITY

ENDODONTIC TREATMENT

1. Initial situation
Sealing deteriorated



2. Root canal treatment
Endodontic treatment necessary on 35 and 36

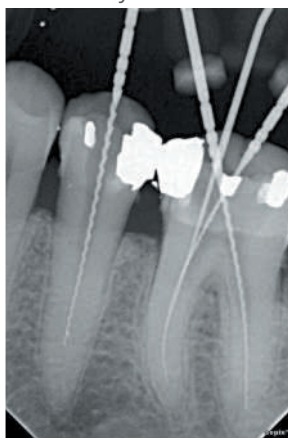

3. End of treatment
Sealing on 35

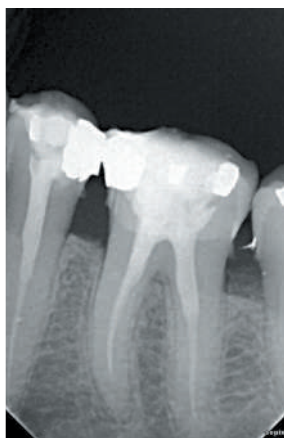

4. After 5 months
Prosthesis placement

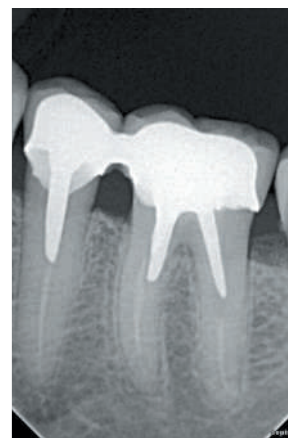

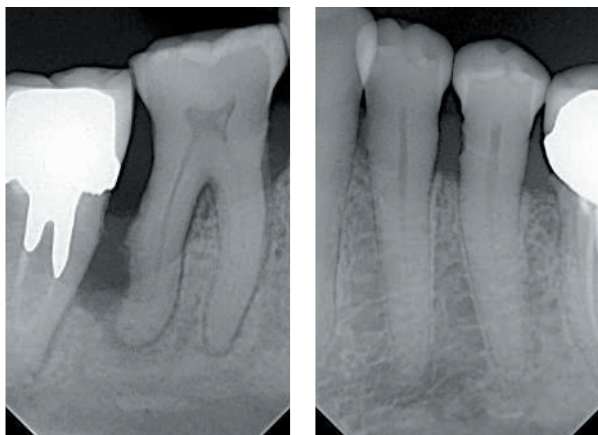

SUB GINGIVAL PLAQUE AND BONE LOSS

Periodontitis

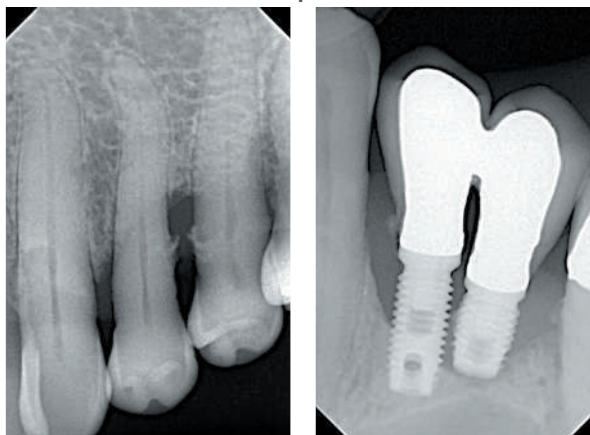

Peri implantitis





PARAMETERS TO MEET YOUR REQUIREMENTS

The X-Mind® unity has a 0.4 mm focal spot.

It has several configurable radiological settings:

- the anodic voltage (60, 65 and 70 kV)
- the anodic current (from 4 to 7 mA)

These parameters ensure a sharp and contrasted image with defined contours.

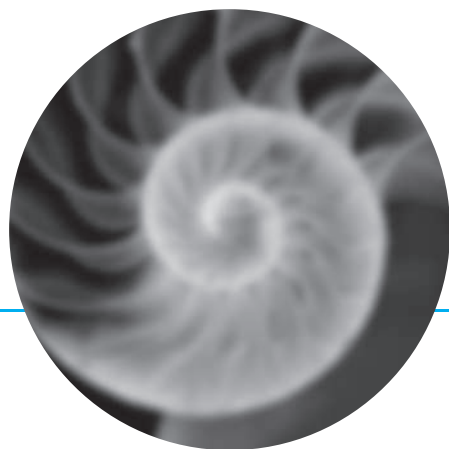

*The generator focal spot Y:
0.7 mm*



*The generator focal spot
of X-Mind® unity: 0.4 mm*

EASY TO INSTALL

SLEEK DESIGN

Because you pay more and more attention to the look and effectiveness of your practice, ACTEON® has developed X-Mind® unity with:

- uncompromising design
- clean lines
- proven quality
- superior materials
- unique technological advantages





X-Mind® unity is pre-wired to allow for the integration of the SOPIX® digital sensor. Therefore, you can simply connect it to your X-Mind® unity at the time of installation or anytime in the future.



SOPIX® inside enables integration without any visible cables. SOPIX® inside connects effortlessly to the X-Mind® unity without technical assistance within a minute.

Plug and Play!

ERGONOMIC AND SIMPLISTIC

A CLEAR AND LARGE LCD SCREEN to easily see the main parameters at a distance

THE "MEMORY" FUNCTION allows modifying for the pre-programmed exposure times to adapt to the specifications of your sensor or film

THE EXPOSURE PARAMETERS are adjusted according to the type of tooth (incisor, premolar, molar)



Acquiring an X-ray is done with the integrated firing switch. A remote firing switch is available as an option.

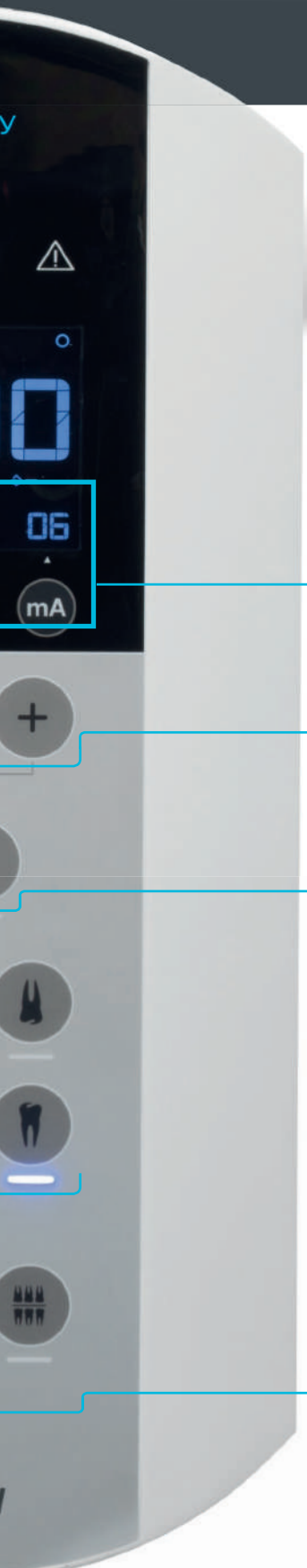

• Displays **THE PARAMETERS** kV, mA, type of film and ACE selection (SOPIX® inside)

• **THE DOSE IS DISPLAYED** when simultaneously pressing the buttons “- and +”

• Selection of the **PATIENT MORPHOLOGY** adult, child

• **SELECTION OF THE EXAM TYPE** occlusal or inter proximal

OUTSTANDING WORK FLOW



FLUID AND STABLE

You can singlehandedly position and stabilize X-Mind® unity.

Movement is fluid and is done without any effort or stress.

The anti-vibration and anti-movement mechanism ensures drift free positioning during an exposure.





X MIND
unity



WORK COMFORT

Due to its ergonomically designed holder, there is no danger of the sensor falling or breaking. The sensor always remains within hands reach for optimal working comfort.

SOPIX® inside is internally wired eliminating the need for external wiring: ease of use and aesthetics of your practice.

MULTIPLE CONFIGURATIONS TO

FLEXIBLE INSTALLATION ALTERNATIVES FOR YOUR PRACTICE

The X-Mind® unity can accommodate any operatory configuration. 3 arm lengths are available: 16 in, 31 in, 43 in and can be:

- top wall mounted
- bottom wall mounted
- mobile

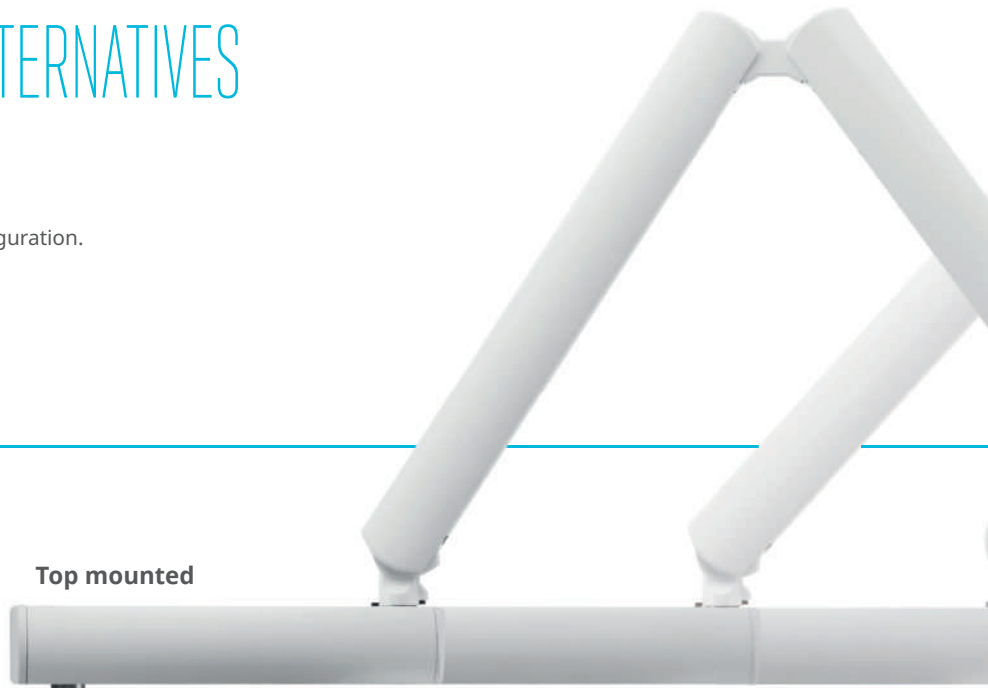

Top mounted



Bottom mounted



Mobile version

ADAPT PERFECTLY



CHOOSE FROM A VARIETY OF CONES
TO BETTER FIT TO YOUR CLINICAL NEEDS



Short round cone



Long round cone



Short square cone



Long square cone

QUIET MIND FOR ALL



EXCLUSIVE TRACEABILITY

The dose received by the patient after each exposure appears on the timer's screen.



When using SOPIX® inside with X-Mind® unity, SOPRO® Imaging systematically records the **X-Mind® unity settings** as well as the **effective dose received by the patient** for each acquisition.

This ensures **permanent traceability** for every patient.





TECHNICAL SPECIFICATIONS

| | |
|------------------------------------|--------------------------------------|
| ● Classification | Class 1 type B |
| ● Supply voltage | 100–240 V |
| ● Maximum power absorption..... | 850 VA |
| ● X-ray tube | TOSHIBA D-041 |
| ● Frequency | 50/60 Hz |
| ● Focal spot..... | 0.4 mm |
| ● Total filtration | >1.5 mm Al @ 70 kV |
| ● Leakage radiation | < 0,25 mGy / h |
| ● Cooling duty cycle for 1 s | 32 s |
| ● Technology | High frequency DC |
| ● Maximum anode current..... | 7 mA |
| ● X-ray tube voltage..... | 60/65/70 kV |
| ● Maximum exposure time | 2 s |
| ● Compatibility | Film, phosphor plate, digital sensor |
| ● Weight | 23 kg |
| ● Configuration | Wall mounting top and bottom, mobile |
| ● Timer | Microprocessor controlled |

ACCESSORIES

| | |
|---|---------------------------|
| ● Circular cone Ø 60 mm | 20 cm (8") or 30 cm (12") |
| ● Rectangular cone 45 x 36 mm | 20 cm (8") or 30 cm (12") |
| ● Arm extension..... | 0.40 m, 0.80 m, 1.10 m |
| ● SOPIX inside/SOPIX ² inside..... | Size 1, size 2 |
| ● Adaptable mounting wall plate | |
| ● Remote exposure switch | |

For more information, please contact:

ACTEON North America
 124 Gaither Dr #140, Mt Laurel, NJ 08054, USA
 Phone +1 877-422-8366 | Fax. +1 856 222 4726
 e-mail : info@us.acteongroup.com | www.acteongroup.usa